

# QST

February, 1939  
25 cents

devoted entirely to

# amateur radio

*in this issue—*

LOW-COST  
BATTERY-OPERATED  
& SUPERBET

MORE ON  
ANTENNAS

ELECTRONIC  
PHONE BREAK-IN



# COLLINS 18

## Mobile Transmitter



The new Collins 18J is a UHF Transmitter specifically designed for use in police patrol cars as part of a two-way communication system.

The transmitter has its frequency controlled precisely by a high-quality quartz crystal and distortion or loss of signal due to frequency drift is thereby eliminated. An improved quality microphone and a low-distortion, high-level plate modulation system faithfully preserves voice articulation.

The power supply unit is unique in that it employs vibrator type converters in place of a dynamotor. The principal feature of the vibrator system is its high efficiency—the total battery drain of the transmitter being less than 30 amperes at 15 watts output at 100% modulation, and this current is required *only* while the operator in the car is talking.

The entire 18J equipment is arranged for simple and convenient installation. A compact cabinet, 12" long x 6" wide x 9" high, contains the transmitter unit itself and a similar cabinet of equivalent dimensions contains the associated power supply. These two cabinets can be mounted side by side in the rear baggage compartment of the car or they can be separated and mounted in any other available space. There are relatively few adjustments to be made in the transmitter on installation since all of the excitation circuits are locked and tuned at the factory. The antenna circuit is adjusted on installation and locked in position. Practically no special wiring is required for installation of the equipment except when it is desired to shorten certain of the cables to eliminate unnecessary length.

We believe that the new 18J cannot be surpassed in convenience, efficiency and reliability. It is the last word in mobile transmitters.

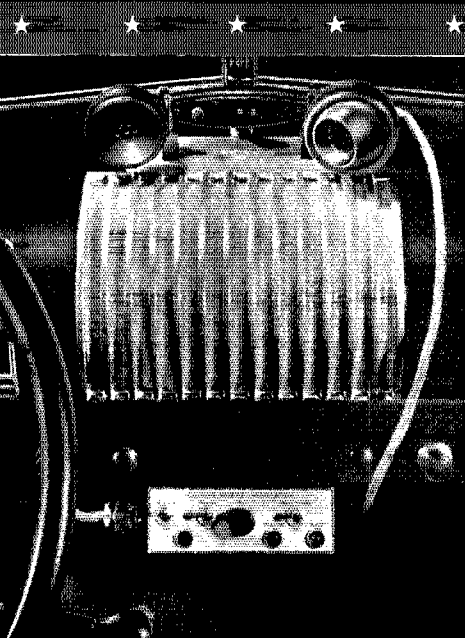

### COLLINS RADIO COMPANY

CEDAR RAPIDS, IOWA  
NEW YORK, N.Y.: 11 WEST 42 ST

# *an Objective* **FOR 1939.**

**T**True progress in any line of endeavor, and this is especially true in building communications equipment, lies in the art of learning how to do things better.

At the Hallicrafters Laboratories, a competent staff of electrical and mechanical engineers spends thousands of hours, not only in developing new equipment, but in searching for ways and means of refining and perfecting our methods of building Hallicrafters receivers and transmitters.

This constant study has enabled us to build better equipment, operating more efficiently and more accurately, without increasing its cost to the radio amateur.

New values and better performance have been added by ingeniously perfecting the art of building communications equipment.

This has always been our objective and will continue to be in 1939 — to keep pace with amateur radio by progressively improving Hallicrafters equipment. The announcement of the 1939 SKY BUDDY on the following page is an example of our efforts in this direction.

*W. J. Halligan*

President

**the hallicrafters inc.**

2611 Indiana Ave., Chicago, U. S. A.

Cable Address: "HALLICRAFT" Chicago

**WORLD'S LARGEST BUILDERS OF AMATEUR COMMUNICATIONS EQUIPMENT**

# the NEW Sky Buddy

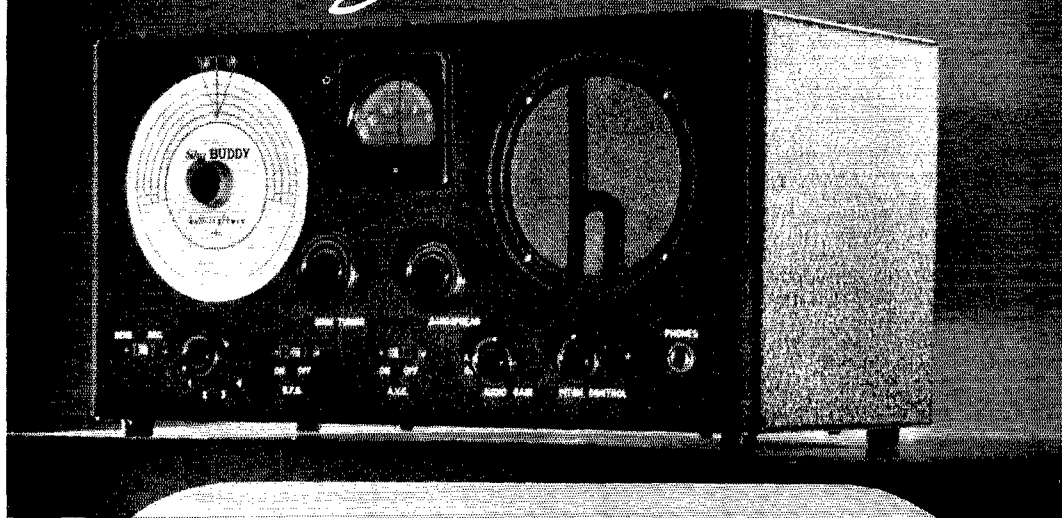

## Now with 10 Meter Band and Electrical Band Spread

How can it be done? Here's a New SKY BUDDY designed to include the 10 meter band and with the same Electrical Band Spread used in higher priced Hallicrafter models, with better all-around performance than ever before—but still selling at the same amazingly low price!

**Here's How We Can Do It!** The SKY BUDDY was first built as a good junior communications receiver for the amateur and short wave listener with a limited purse. Since then OVER 10,000 SKY BUDDIES have been built. With such widespread acceptance, we have been able to make progressive improvements in this sensational receiver without adding to its cost!

This NEW SKY BUDDY has sensitivity, image ratio, signal-to-noise ratio and all-around performance that excels many receivers sold at twice its price. It's complete, with all the essential controls for communications reception, built-in speaker, full coverage from 44 MC to 545 KC—a far greater value than ever before. See it at your Hallicrafters dealer, or write for complete information.

### Check These Features!

- |                                     |                             |
|-------------------------------------|-----------------------------|
| ★ 6 Tubes with 8 Tube Performance   | ★ Beat Frequency Oscillator |
| ★ 4 Bands                           | ★ Pitch Control             |
| ★ Complete Coverage 44 MC to 545 KC | ★ Send-Receive Switch       |
| ★ Covers 10 Meter Band              | ★ Phone Jack                |
| ★ Electrical Band Spread            | ★ Band Switch               |
| ★ Separate Band Spread Dial         |                             |
| ★ Built-in Speaker                  | ★ AVC Switch                |

Amateurs Net Price **\$29.50** Complete

the hallicrafters inc.

2611 Indiana Avenue, Chicago, U. S. A. • Cable Address: "HALLICRAFT," Chicago  
 WORLD'S LARGEST BUILDERS OF AMATEUR COMMUNICATIONS EQUIPMENT

FEBRUARY 1939

VOLUME XXIII

NUMBER 2



STAFF

EDITORIAL

KENNETH B. WARNER  
Editor and Business Manager

CLARK C. RODIMON  
Managing Editor

JAMES J. LAMB  
Technical Editor  
(on leave of absence)

GEORGE GRAMMER  
Acting Technical Editor

DONALD H. MIX &  
THOMAS M. FERRILL, JR.  
Technical Assistants

VERNON C. CHAMBERS  
Laboratorian

ADVERTISING

F. CHEYNEY BEEKLEY  
Advertising Manager

CHARLES BRUNELLE  
Asst. Advertising Manager

CIRCULATION

DAVID H. HOUGHTON  
Circulation Manager

RALPH T. BEAUDIN  
Asst. Circulation Manager



OFFICES

38 La Salle Road  
West Hartford, Connecticut

Subscription rate in United States and Possessions and Canada, \$2.50 per year, postpaid; all other countries, \$3.00 per year, postpaid. Single copies, 25 cents. Foreign remittances should be by international postal or express money order or bank draft negotiable in the U. S. and for an equivalent amount in U. S. funds.

Entered as second-class matter May 29, 1919, at the post office at Hartford, Connecticut, under the Act of March 3, 1879. Acceptance for mailing at special rate of postage provided for in section 1103, Act of October 3, 1917, authorized September 9, 1922. Additional entry at Concord, N. H., authorized February 21, 1929, under the Act of February 28, 1925. Additional second-class entries to cover sectional editions authorized March 20, 1935.

Copyright 1939 by the American Radio Relay League, Inc. Title registered at United States Patent Office.

# QST

devoted entirely to

# AMATEUR RADIO

PUBLISHED, MONTHLY, AS ITS OFFICIAL ORGAN, BY THE AMERICAN RADIO RELAY LEAGUE, INC., AT WEST HARTFORD, CONN., U. S. A.; OFFICIAL ORGAN OF THE INTERNATIONAL AMATEUR RADIO UNION



## CONTENTS

Editorials . . . . .	7
A Six-Tube Battery-Operated Single-Signal Superheterodyne <i>Don H. Mix, W1TS</i>	9
Splatter . . . . .	14
Rescue at 11,000 Miles . . . . .	15
Resuscitation from Electrical Shock . . . . . <i>Clinton B. DeSoto</i>	16
New Acorn Tubes . . . . .	18
What the League Is Doing . . . . .	19
A.R.R.L.'s 11th International DX Competition <i>F. E. Handy, W1BDI</i>	20
Hamdom . . . . . <i>Freeman F. Gosden, W6QUT</i>	23
The "Q" Beam Antenna . . . . . <i>Lloyd W. Olander</i>	24
Modernizing the 56-Mc. Receiver . . . . . <i>Jack Wagenseller, W3GS</i>	28
Philip C. Murray, (W9VYU) . . . . .	31
Eight Years Before the Mike . . . . . <i>W9BSP-W9UA</i>	32
What's Your Crystal Frequency? . . . . . <i>Don L. Lusk, W3ZF</i>	33
Break-In Telephony With Carrier Suppression <i>S. Kaplan, PAOCM</i>	36
Book Reviews . . . . .	39
Using Electromagnetic-Deflection Cathode-Ray Tubes in the Television Receiver . . . . . <i>J. B. Sherman</i>	40
Landmark Becomes Ham Emergency Center . . . . .	45
Naval Communication Reserve Notes . . . . .	46
Simple Vertical Antennas . . . . . <i>T. M. Ferrill, Jr., W1LJI</i>	47
An Economical Six-Band Transmitter <i>Harold Roberts, W1KUK</i>	50
New Apparatus . . . . .	52
1.75 Mc. WAS Party . . . . .	52
Navy Day . . . . .	53
Factors Influencing the "Q" of R.F. Coils in Amateur-Band Receivers . . . . . <i>Dale Pollack</i>	54
B. C. I. and the Amateur . . . . . <i>L. C. Waller, W2BRO</i>	58
How Would You Do It? . . . . .	60
Hints and Kinks . . . . .	62
I.A.R.U. News . . . . .	65
Correspondence Department . . . . .	67
Operating News . . . . .	68
Silent Keys . . . . .	98
Hamads . . . . .	123
QST's Index of Advertisers . . . . .	126

## Section Communications Managers of the A.R.R.L. Communications Department

All appointments in the League's field organization are made by the proper S.C.M., elected by members in each Section listed. Mail your S.C.M. (on the 16th of each month) a postal covering your radio activities for the previous 30 days. Tell him your DX, plans for experimenting, results in 'phone and traffic. He is interested, whether you are an A.R.R.L. member or get your QST at the newsstands; he wants a report from every active ham. If interested and qualified for O.R.S., O.P.S. or other appointments he can tell you about them, too.

<b>ATLANTIC DIVISION</b>				
Eastern Pennsylvania Maryland-Delaware-District of Columbia Southern New Jersey Western New York Western Pennsylvania	W3QP W3BAK W3BEI W3CSE W8OFO	John B. Morgan Edgar L. Hudson W. W. Filson Ed. Preston Kendall Speer, Jr.	Blue Bell Laurel, Delaware Audubon Tully Lowber	
<b>CENTRAL DIVISION</b>				
Illinois Indiana Kentucky Michigan Ohio Wisconsin	W9RMN W9QG W9ARU W8DPE W8AQ W9UIT	Leslie M. Dickson Noble Burkhart Darrell A. Downard Harold C. Bird F. H. Gibbs Aldrich C. Krones	Edeltn Farms R. 4, Box 1 116 N. Longworth Ave. R.F.D. 2 405 Broad St. 3127-A West Madison St.	Waukegan Indianapolis Louisville Pontiac Wadsworth Milwaukee
<b>DAKOTA DIVISION</b>				
North Dakota South Dakota Northern Minnesota Southern Minnesota	W9RZA W9VOD W9IGZ W9YNQ	Ernest Bloch Dr. A. L. Russell Edwin L. Wicklund Millard L. Bender	Box 202 R.F.D. 3 608 N. Huron Ave.	Thompson Phillip Kensington Spring Valley
<b>DELTA DIVISION</b>				
Arkansas Louisiana Mississippi* Tennessee	WSABI W5DKR W5GFW W4DWS	H. E. Velte Eugene H. Treadaway Robert E. Barr William Harold Walker	4415 West 12th St. 2749 Myrtle St. 301 Boscobel	Little Rock New Orleans Luucedale Nashville
<b>HUDSON DIVISION</b>				
Eastern New York N. Y. C. & Long Island Northern New Jersey	W2LU W2AZV W2GMM	Robert E. Haight E. L. Baunach Fred C. Read	511 South Holmes St. 102 Central Ave. 1014 North Ave.	Scotia Masapequa, L. I. Elizabeth
<b>MIDWEST DIVISION</b>				
Iowa Kansas Missouri Nebraska	W9ARE W9TEG W9OUD W9FAM	Clyde C. Richelieu Melvin D. Kirby Miss Letta Allendorf Samuel C. Wallace	Radio Farm 1015 W. 3rd St. Green St.	Burlington Arkington Joplin Clarks
<b>NEW ENGLAND DIVISION</b>				
Connecticut Maine Eastern Massachusetts Western Massachusetts New Hampshire Rhode Island Vermont	W1CTI W1FBJ W1IWC W1JAH W1BFT W1RRC W1GNF	Frederick Ellis, Jr. Winfield A. Ramsdell Sam Gross William J. Barrett Carl B. Evans Clayton C. Gordon Alvin H. Battison	19 Merrill Rd. 1188 Washington Ave. Pleasant St. 239 Columbia St. 163 South Main St. 192 Washington Ave. 1 Central St.	Norwalk Portland Marshfield Hills Adams Concord Providence Windsor
<b>NORTHWESTERN DIVISION</b>				
Alaska Idaho Montana Oregon Washington	K7ENA W7EMT W7FL W7DNF W7FCF	Leo E. Osterman Carl Eichelberger C. A. Woodhouse Harold W. Johnston W. Beale	Customhouse Route 2 Holter Dam 205 North Grant St. R. 4, School Ave.	Wrangell Kuna Wolf Creek Pendleton Walla Walla
<b>PACIFIC DIVISION</b>				
Hawaii* Nevada Santa Clara Valley East Bay San Francisco Sacramento Valley Philippines San Joaquin Valley*	K6OTH W6BIC W6FBV W6LTV W6SG W6GZY KA1GR W6NJQ	Hugh Cecil Rea Edward W. Heim Elbert Amarantes Harold J. Burchfield Alan D. Whittaker, Jr. J. L. C. Buckenham George L. Rickard Clarence Ramer	1925 Keeaumoku St. 509 Claremont St. 454 Washington St. 2340 100th Ave. 79 Elinor Ave. 2931 24th St. Box 849 941 Clinton Ave.	Honolulu Keno San Jose Oakland Mill Valley Sacramento Manila Fresno
<b>ROANOKE DIVISION</b>				
North Carolina South Carolina Virginia West Virginia	W4OG W4BOE W4JVA W8HD	H. S. Carter Ted Ferguson Charles M. Waff, Jr. C. S. Hoffmann, Jr.	P. O. Box 111 1213 College St. 267 Stuart Ave. 47 Lynwood Ave.	Winston-Salem Columbia Richmond Wheeling
<b>ROCKY MOUNTAIN DIVISION</b>				
Colorado Utah-Wyoming	W0FHC W7CLG	Carl C. Drumeller Ernest E. Parshall	1828 East Kiowa St. Salt Creek Electric Plant	Colorado Springs Midwest, Wyoming
<b>SOUTHEASTERN DIVISION</b>				
Alabama Eastern Florida Western Florida* Georgia West Indies (Cuba-Isle-of-Pines- Porto Rico-Virgin Islands)	W4DGS W4DVO W4AXP W4AGI CM2OP	James F. Thompson A. A. Connolly Oscar Cederstrom Leland W. Smith Mario de la Torre	1203 South Perry St. 719 So. Willow Ave. Second St. & Bruce Ave. 2010 Pennsylvania Ave. Escobar 110 (Altos)	Montgomery Tampa De Funiak Springs Augusta Habana, Cuba
<b>SOUTHWESTERN DIVISION</b>				
Los Angeles Arizona San Diego	W6MQM W6KFC W6JRM	Ralph S. Click Victor C. Clark Howard K. Breedlove	1038 Milwaukee Ave. 747 E. Polk St. R. 2, Box 636	Los Angeles Phoenix San Diego
<b>WEST GULF DIVISION</b>				
Northern Texas Oklahoma Southern Texas New Mexico	W5DNA W5CEZ W5BHO W5CGJ	Lee Hughes Carter L. Simpson Dave H. Galt Joseph M. Eldott	125 N. Main St. 2010 So. 4th St. 6726 Ave. Q	Childress Ponca City Fritch Chamita
<b>MARITIME DIVISION</b>				
Maritime	VE1DQ	A. M. Crowell	69 Dublin St.	Halifax, N. S.
<b>ONTARIO DIVISION</b>				
Ontario	VE3SG	Fred H. B. Saxon	302 Lee Ave.	Toronto, Ont.
<b>QUEBEC DIVISION</b>				
Quebec	VE2CO	Lindsay G. Morris	Apt. 6, 4510 Girouard Ave., N.D.G.	Montreal, P. Q.
<b>VANALTA DIVISION</b>				
Alberta British Columbia	VE4GE VE5HP	C. S. Jamieson J. Hepburn, Jr.	581 W. Riverside Drive 335 Foul Bay Road	Drumheller, Alta. Victoria
<b>PRAIRIE DIVISION</b>				
Manitoba Saskatchewan	VE4BG VE4SY	A. J. R. Simpson Arthur Chesworth	635 Garfield St. 1071 4th Ave., N. W.	Winnipeg Moose Jaw

\* Officials appointed to act until the membership of the Section choose permanent S.C.M.s by nomination and election.

# To the HALLICRAFTERS

We wish to take this opportunity to congratulate the Hallicrafters on another engineering triumph. This new 325 watt transmitter, comprising the latest in circuits and advanced developments is an outstanding piece of apparatus. Kenyon is indeed proud to be associated with the name Hallicrafters, just as proud as you will be when your rig is KENYONIZED.

See your dealer today and ask him of the many advantages of our products. Such features as sealed against moisture, completely dehydrated and **GUARANTEED** make these transformers a natural for your rig. Don't wait. . . . **GET KENYONIZED!!!!!!**

*Send for our new 1939 catalog describing our complete line. Mailed free upon request!*



**KENYON** TRANSFORMER  
COMPANY, INC.

840 BARRY STREET

NEW YORK, N. Y.

Export Department 25 Warren St., New York, N. Y.

# THE AMERICAN RADIO RELAY LEAGUE

## Directors

<i>President</i>	
EUGENE C. WOODRUFF	W8CMP
234 W. Fairmount Ave., State College, Pa.	
<i>Vice-President</i>	
GEORGE W. BAILEY	W1KH
74 Webster Road, Weston, Mass.	
<i>Canadian General Manager</i>	
ALEX REID	VE2BE
169 Logan Ave., St. Lambert, P. Q.	
<i>Atlantic Division</i>	
WALTER BRADLEY MARTIN	W3QV
Box 612, Roslyn, Pa.	
<i>Central Division</i>	
R. H. G. MATHEWS	ex-W9ZN
100 East Ohio St., Chicago	
<i>Dakota Division</i>	
FRED W. YOUNG	W9MZN
107 Hanover St., Mankato, Minn.	
<i>Delta Division</i>	
E. RAY ARLEDGE	W58I
P.O. Box 286, Pine Bluff, Ark.	
<i>Hudson Division</i>	
KENNETH T. HILL	W2AHC
115 Willow St., Douglaston, L. I., N. Y.	
<i>Midwest Division</i>	
FLOYD E. NORWINE, JR.	W9EFC
120 South Fourth St., St. Louis, Mo.	
<i>New England Division</i>	
PERCY C. NOBLE	W1BVR
37 Broad St., Westfield, Mass.	
<i>Northwestern Division</i>	
RALPH J. GIBBONS	W7KY
c/o United Air Lines, Portland, Ore.	
<i>Pacific Division</i>	
J. L. McCARGAR	W6EY
66 Hamilton Pl., Oakland, Calif.	
<i>Raleigh Division</i>	
H. L. CAVENESS	W4DW
State College Station, Raleigh, N. C.	
<i>Rocky Mountain Division</i>	
GLEN R. GLASSCOCK	W9FA
2184 So. Corona St., Denver	
<i>Southeastern Division</i>	
BENNETT R. ADAMS, JR.	W4APU
1512 Grove Place, Homewood, Ala.	
<i>Southwestern Division</i>	
CHARLES E. BLALACK	W6GG
443 Main St., El Centro, Calif.	
<i>West Gulf Division</i>	
WILLIAM A. GREEN	W5BKH
801 Ross St., Abilene, Texas	

THE AMERICAN RADIO RELAY LEAGUE, INC., is a non-commercial association of radio amateurs, bonded for the promotion of interest in amateur radio communication and experimentation, for the relaying of messages by radio, for the advancement of the radio art and of the public welfare, for the representation of the radio amateur in legislative matters, and for the maintenance of fraternalism and a high standard of conduct.

It is an incorporated association without capital stock, chartered under the laws of Connecticut. Its affairs are governed by a Board of Directors, elected every two years by the general membership. The officers are elected or appointed by the Directors. The League is non-commercial and no one commercially engaged in the manufacture, sale or rental of radio apparatus is eligible to membership on its board.

"Of, by and for the amateur," it numbers within its ranks practically every worth-while amateur in the nation and has a history of glorious achievement as the standard-bearer in amateur affairs.

Inquiries regarding membership are solicited. A bona fide interest in amateur radio is the only essential qualification; ownership of a transmitting station and knowledge of the code are not prerequisite. Correspondence should be addressed to the Secretary.



HIRAM PERCY MAXIM, FIRST PRESIDENT

## Officers

<i>President</i>	EUGENE C. WOODRUFF, W8CMP
	State College, Pa.
<i>Vice-President</i>	GEORGE W. BAILEY, W1KH
	Weston, Mass.
<i>Secretary</i>	KENNETH B. WARNER, W1EH
	West Hartford, Connecticut
<i>Treasurer</i>	ARTHUR A. HEBERT, W1ES
	West Hartford, Connecticut
<i>Communications Mgr.</i>	F. EDWARD HANDY, W1BDI
	West Hartford, Connecticut
<i>General Counsel</i>	PAUL M. SEGAL
	1026 Woodward Building, Washington, D. C.

Address all general correspondence to the administrative headquarters at West Hartford, Connecticut.



# "IT SEEMS TO US—"

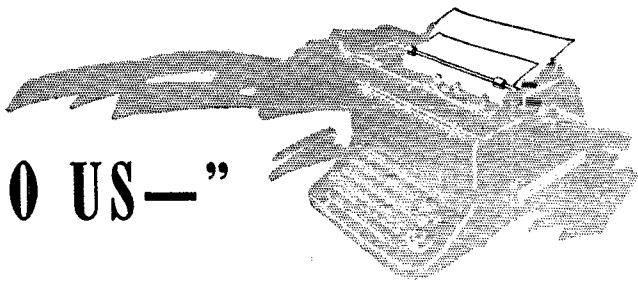

## "... AND SUDDEN DEATH"

HERE at A.R.R.L. Headquarters we have become dreadfully conscious in recent months of the increasing danger of electrical death or maiming which exists in present-day amateur transmitters. Reduced prices of apparatus make high power a commonplace now, so that tens of thousands of amateur stations have become potential lethal machines. Following upon the death of Ross Hull we have heard of far too many serious accidents to regard the situation with any complacency, and we are obliged to record in this issue the death by electrocution of another of our members. The situation calls for strong measures, and at once.

To show that we are not fighting a straw man, we want to quote from a letter we received recently from a well-known W9 DX man who has had a terrible experience but has been so fortunate as to live to tell about it. Get this:

"On the evening of August 6th I was sitting at the receiver listening to the European DX roll in during the DJDC contest. Upon hearing a D4 blast a CQ, I decided to change frequency and call him. In doing so I forgot to throw the switch on the 115-volt line and, after making a few adjustments, didn't know the juice was on and got across my 3000-volt final, my right hand on the chassis, my left hand on the antenna feeder. I couldn't let go of the thing and so I was blazing away, until my dad came and threw the switch and pulled me off. When I came to, my whole left hand was shattered, my right hand practically charred and burned crisp, a groove in my chest, my face burned and body full of shock. After calling a doctor a quick call brought the gendarmes and the blue wagon, and so away to the county hospital where I was confined for nearly two and a half months. For two weeks the doctors were doubtful whether the hand would have to be removed but after a determined effort it was saved — both of them, as a matter of fact. However, the index finger was so badly shattered that after two weeks it fell off; the nail had been completely dissolved while hanging on the tank circuit. The thumb was half of what it should have been, and healed that way. The index finger on the left hand is off to the second joint. The thumb, although very gruesome-looking, is still on the hand but can't be bent. Chest completely healed but scarred all over. Must return to the hospital after the holidays to undergo an operation to increase the spread between index finger and thumb. Missed the national convention, though I pleaded with the doctor to let me have about 32 hours leave; he flatly refused. So all I did was lie around and read books. Was in the hospital when I heard of Ross Hull's terrible accident and it sent another chill down my spine. A pity Ross had to go that way. From the

intensity of my own burns the doctors estimated I was on the tank between 23 and 30 seconds, so you can see what really happened. . . . Returned from the hospital . . . and at present am off the air to put in . . . some relays, fire bells, gongs, chimes and warning signals, so when I get within five feet of the rig everything will go off and warn me. Here's hoping I don't go through another experience like that; it's far too costly."

Fellows, if reading that letter makes your flesh crawl, just think what the electricity did to this poor OM, and resolve that you won't let it happen to you. And there are plenty of other cases to cite. [The recent death of W9VYU through the breakdown of a small rectifier-filament transformer is reported elsewhere in this issue.] . [One of the best-known experimenters in the country is nursing bad r.f. burns across all the fingers of both hands; he was laying a temporary shunt across an r.f. ammeter while holding a portable key in the other hand, and somehow the key contacts closed.] . [An eastern amateur a few years ago, groggy from too long a vigil, went to sleep with his feet on the power transformer under the table, slipped down a little in his chair, and woke no more.] . [A former director of the League is alive to-day with bad burns only because he had a friend in the shack who promptly pulled the switch when he saw that something had gone amiss.] . [We know a fellow who took the charge of a filter condenser when a bleeder went out and who sat paralyzed on the floor, alone, for a half an hour, escaping without a mark but with a terrifying story of scarcely being able to breathe, with a sensation as though a trousers belt were tightly drawn around his chest.] . [We know another, equally fortunate, who took a wire off a 2000-volt metal binding post, felt nothing because he was insulated from earth, didn't know the thing was hot until he pulled a flaming arc as he removed the wire — but who is now a much wiser man.] These narrow escapes only throw into sharper relief the growing number of sadder and less fortunate cases.

Resolved, as we at QST are, that something definite must be done about this situation, we have been having a series of staff conferences on the subject in recent weeks, and we have now to announce that QST embarks upon a pointed campaign to make amateur radio operating safer. We are going to tell you how to make your station

better than reasonably safe, and we're going to tell you how to conduct yourself to avoid trouble. We can't go much farther than that, because you have to build and adjust and operate your gear yourself. But we're going to din it everlastingly into you to be careful, and we hope that we may succeed in making you safety-conscious. If we can show the way, and if we can then excite you into a realization of the need for care and into the development of personal safety practices, we can take care of this appalling situation. Herewith an announcement of some of the elements of our program:

1. First, of course, come personal precautions. No rig can be made completely foolproof, because it does involve high tension and it does have to be adjusted. The most important element is the course of conduct of the operator — the things he should do to avoid danger. We are now engaged in writing some urgent recommendations to you on this subject, and expect to publish them next month.

2. Next come actual constructional considerations in apparatus itself. There is much about our gear that, from the safety standpoint, runs all the way from the moderately hazardous to the supercollusy. We believe we have been too intent in the past on performance, not sufficiently conscious of safety principles. Choice of circuit, selection and arrangement of components, protection of terminals, application of sound electrical principles to put earth potentials where they belong — these are some of the factors now under study. Result is going to be an A.R.R.L. safety code of building precepts. It is now in preparation and will be published next issue.

3. Also receiving detailed study is the whole subject of special safety devices, intended to supplement the construction code and to safeguard as far as possible against carelessness on the part of the operator. A report on this field will be rendered soon, supplemented throughout the year by as much additional material and as many new ideas as we can marshal.

4. The American manufacturers of amateur gear are being asked to coöperate in this safety campaign by making alterations in existing equipment designs to make them safer and by producing certain new articles which our studies indicate should be available for amateur protection.

5. The hundreds of local amateur clubs affiliated with A.R.R.L. will be asked to participate in this movement by appointing safety committees to inspect local stations and assist their members in making their stations safer.

6. As we embark upon this new work, it has been tremendously borne home to us that every amateur ought to know the technique of administering artificial respiration. It is the standard method of resuscitation from electrical shock. To fill this need we publish this month a special

article on the subject. We plead for its most careful study, absorption and practice.

So much as an outline of our intentions. Through the months to come we'll give you the material as fast as we can create it. Be prepared to be preached at, because we want to save your life and it depends largely upon whether you'll listen and heed. One item in particular needs some hammering upon right now:

Perhaps as dangerous as any other factor is the false sense of security hams have concerning "low" voltages — ranging from the 115 volts on the a.c. line through the 500- and 600-volt category. Elsewhere in this very issue the lethal capabilities of a 500-volt supply are only too tragically demonstrated. But most of us don't realize that more people are killed by 115-volt circuits than any other, and that this applies not only to the general public but to public-utilities linemen who work as often on higher voltages as not. It isn't the voltage that's so important; in fact, the higher voltages often induce a muscular convulsion which by its own action frees the victim from the circuit. With the lower voltages one simply hangs on and can't get free. Then it's a matter of  $I^2R$  loss . . . and the lower brain paralyzes . . . and your breathing stops . . . and if there's no one there to apply artificial respiration within the next 60 seconds or so you die. . . .

Gruesome? We mean it to be, because we want you to realize it's true. It has happened and it will happen again; whether or not it happens to you depends largely upon yourself and the precautions you use.

Many of us, it is true, have "taken" several hundred volts, and even more, at some time or other and lived to tell the tale. Often there were practically no ill effects at all. But this fact, when analyzed, demonstrates only that *contact* — the gateway for the current to enter the body — is the important thing, far more important than voltage. If you get bitten and jerk away, you're safe. If you get bitten and can't jerk away, you're done.

Confidence based on past experience is often misplaced. Just because that 1000-volt supply nipped you once and the only result was a sense of numbness and nausea and a curious lightheadedness — just because you got away with it once doesn't mean you could do so again. A great deal depends upon your physical condition. Just what the relationship is our medical authorities don't know as yet, but there is one. Weak hearts, of course, are notoriously susceptible. Next year, next month, perhaps even the next day, a little power pack can tie you up in a knot with your knees digging into your belly and your arms stiff as iron rods and your consciousness snuffed out like a candle dropped in a manhole.

*Get safety-conscious! ALWAYS BE CAREFUL!*

K. B. W.

# A Six-Tube Battery-Operated Single-Signal Superheterodyne

*Making Use of the New 1.4-Volt Low-Drain Tubes*

BY DON H. MIX,\* WITS

TO THE ham who lives in the city, juice is something that comes from a wall outlet and costs from 2 to 10 cents per kilowatt hour and the supply never (well, almost never) becomes exhausted. To the hundreds who live in the wide open spaces, it is often something that comes in a package and costs about \$10 per kilowatt hour! The former has little to worry about, the latter worries plenty. An extra tube in a receiver is a real problem to him — or has been heretofore. In the past, the high cost of battery supply has placed serious restrictions upon those who would design a battery receiver with better performance than the two-tube regenerative receiver which is rapidly passing into history wherever cheap power is available. A battery-operated superhet of the "communications" type has been economically impossible.

The recently announced series of 1.4-volt battery tubes, however, is going to mean a new deal for the ham in an isolated location. These tubes are going to make it possible for him to enjoy some of the refinements in receiver design which his city cousin now considers indispensable. The

six tubes in the receiver to be described, for example, draw a total filament current equal to that of one r.f. tube of the 6.3-volt series, and that at the voltage of a single dry cell. Only two 45-volt "B" batteries are required and the total current drawn from these is only 20 ma. The light pentode output stage will deliver headphone signals with a sock which will delight the most hardened tin ear; a loudspeaker may be operated in good shape.

## Circuit

It may be noticed from the diagram that the circuit is essentially an adaptation of the principles of the low-cost single-signal receiver described in *QST* for October.<sup>1</sup> It is a particularly logical arrangement for the purpose at hand. Regeneration in the mixer stage supplies preselection equivalent to a stage of r.f. without regeneration and, in the i.f. amplifier, provides an inexpensive means of obtaining single-signal selectivity. Variable potentiometers, operating from the 4.5-volt "C" battery required for the output tube, control regeneration in each of these stages by varying the grid bias. Feed-back in the i.f. amplifier is provided by a small grid-plate capacity ( $C_g$ ) formed by connecting a short length of in-

\* Technical Department.

<sup>1</sup> Grammer, "A Low-Cost Single-Signal Receiver," *QST*, October, 1938.

◆  
The chassis fitted into a standard metal cabinet which accommodates batteries as well.  
◆

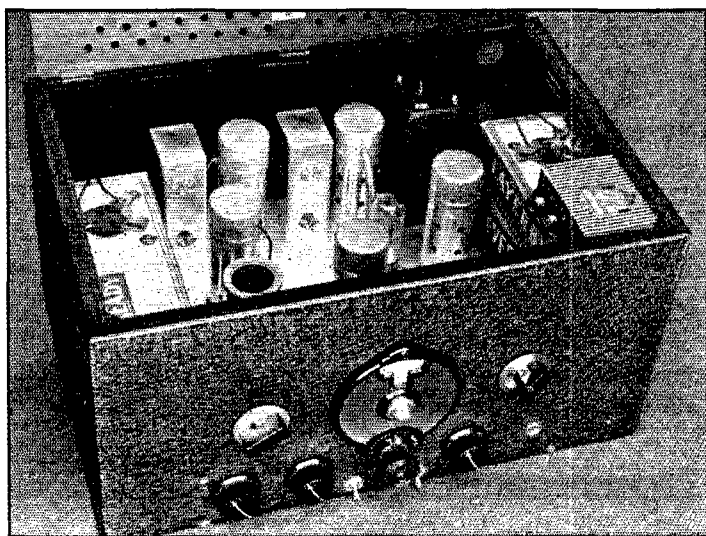

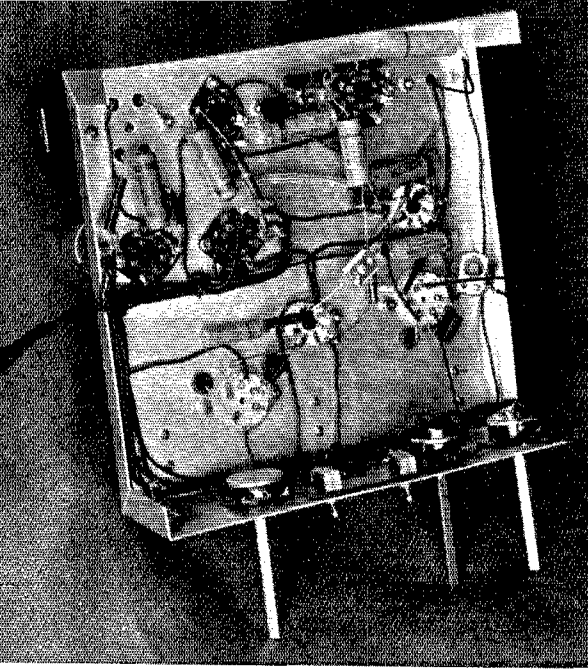

◆  
**Bottom view of chassis showing wiring. Parts are arranged so that high-frequency wiring is short and direct. The push-back power wiring is bunched into a cable.**  
 ◆

ulated wire to the grid cap of the 1N5G and running it down inside the shield near the plate of the tube.

The 1H5G is a combination half-wave diode and high- $\mu$  triode in one envelope. The grid circuit of the triode audio section is coupled across the diode load resistance  $R_5$ . The audio gain control  $R_8$  is desirable to reduce signals to comfortable headphone strength when the mixer and i.f. stages are adjusted for maximum selectivity which is accompanied by maximum gain.

The 1A5G pentode, with plate and screen connected together, is used in both high-frequency and beat-oscillator circuits since the 1.4-volt series does not yet include a triode. The grid of the h.f. oscillator is coupled through a small adjustable capacity to the No. 1 grid of the mixer. Because these tubes do not have independent cathodes, the tickler system of feed-back must be used in the oscillator circuits. It should be noted that not all transformer manufacturers list a beat oscillator unit suitable for this circuit.

The power-supply switches are arranged so that opening either the "A" switch ( $SW_1$ ) when turning the receiver off, or the "B" switch ( $SW_2$ ) for stand-by while transmitting, will disconnect the load of the two potentiometers from the "C" battery. A separate "A" switch ( $SW_3$ ) controls the beat oscillator.

### **The Chassis**

Most of the constructional details may be determined by a careful study of the various photographs. In cases where a battery receiver is designed particularly for portable work of the type which requires carrying the equipment on the person, there is justification for compact and

light-weight construction. In a receiver intended primarily as permanent station equipment, however, greater weight is desirable so that the receiver will stay in place while operating the controls or plugging in the headphones and a half-Nelson grip or scissors lock on the receiver will not be required when changing coils. Enough panel and chassis space should be available to avoid excessive crowding of controls and to make coil changing convenient. Accordingly a standard cabinet was selected with dimensions which would accommodate batteries of respectable size and a chassis was cut to fit the remaining space. A National NC-80 cabinet has the desired dimensions (17 by 11 by  $8\frac{3}{4}$  inches). A standard 45-volt "B" battery such as the Burgess No. 22308 or Eveready No. 485 and a 1 $\frac{1}{2}$ -volt No. 6 or Burgess No. 4F2 will fit in at each end of the cabinet with room for a 10 $\frac{1}{2}$ -by-10 $\frac{1}{2}$ -inch chassis. The weight of the batteries will anchor the receiver to the operating table.

The chassis is made from a sheet of  $\frac{1}{8}$ -inch aluminum 12 inches wide and 16 $\frac{1}{2}$  inches long. Deep scratches should be ruled on each side of the sheet parallel with, and 3 inches from, each of the shorter edges of the sheet to make bending easier. Similar scratches should be ruled parallel with and  $\frac{3}{4}$  inch from, the longer edges. Notches 90 degrees wide should be cut at the intersection of the lines to permit bending along the scratched lines. Before bending, the parts should be arranged within the 10 $\frac{1}{2}$ -inch square formed by the lines and the necessary holes marked for drilling since it is more convenient to do the drilling before bending the chassis.

At the rear of the chassis, the first i.f. transformer, the 1N5G, the second i.f. transformer, the 1H5G and the beat oscillator unit are arranged in a line from left to right, their centers placed on a line about 1 $\frac{1}{2}$  inches from the scratch denoting the rear edge of the chassis. If a test oscillator will not be available for aligning the i.f. stages, particular care should be taken not to disturb the original i.f. transformer adjustment. The 1A7G mixer tube, the output audio amplifier tube and the beat oscillator tube are arranged along another line 4 $\frac{1}{2}$  inches from the rear edge of the chassis. The mixer tube should be placed far enough toward the center of the chassis to permit adjustment of the first i.f. transformer with a small screwdriver.

The three variable condensers from left to right are the mixer tuning, the oscillator band-spread and oscillator padding or bandsetting con-

### COIL DATA

Band	Coil	Wire Size	Turns	Length	Tap
1.75 Mc.	L <sub>1</sub>	24	70	Close-wound	—
	L <sub>2</sub>	24	10	—	—
	L <sub>3</sub>	24	3.5	"	—
	L <sub>4</sub>	22	42	"	Top
	L <sub>5</sub>	22	8	"	—
3.5 Mc.	L <sub>1</sub>	22	35	"	—
	L <sub>2</sub>	22	7	"	—
	L <sub>3</sub>	22	2.5	"	—
	L <sub>4</sub>	22	25	1 inch	17
	L <sub>5</sub>	22	5	Close-wound	—
7 Mc.	L <sub>1</sub>	18	20	1 inch	—
	L <sub>2</sub>	22	4	Close-wound	—
	L <sub>3</sub>	22	2	"	—
	L <sub>4</sub>	18	13	1 inch	6
	L <sub>5</sub>	22	3	Close-wound	—
14 Mc.	L <sub>1</sub>	18	11	1 inch	—
	L <sub>2</sub>	22	4	Close-wound	—
	L <sub>3</sub>	22	2.5	"	—
	L <sub>4</sub>	18	7	1 inch	2.4
	L <sub>5</sub>	22	2	Close-wound	—
28 Mc.	L <sub>1</sub>	18	5	1 inch	—
	L <sub>2</sub>	22	3	Close-wound	—
	L <sub>3</sub>	22	2.5	"	—
	L <sub>4</sub>	18	3.6	1 inch	1.3
	L <sub>5</sub>	22	1.4	Close-wound	—

All coils 1½ inches in diameter, on Hammarlund SWF forms. Spacing between coils on same form approximately ½ inch. Band-spread taps are measured from bottom (ground) end of L<sub>4</sub>. All coils are wound with enamelled wire.

coil is wound on a 6-prong form and the oscillator coil on a 5-prong form. Isolantite sockets are used only in the high-frequency circuits. The tube shields are 3-piece standard products 1⅝ inches in diameter, 4½ inches high with a base to fit the mounting holes of octal sockets. If desired, the lower half-inch of the shield may be cut off with tin shears to shorten the shield. Holes for a pair of antenna coil terminals and a chassis ground connection may be cut near the rear of the chassis. This completes preparation of the top of the chassis.

In the 3-inch wide strip which will form the front edge of the chassis, a row of holes should be drilled 1½ inches from the lower edge for the three gain controls and the phone jack and another pair of holes ½ inch from the lower edge for the two toggle switches. The gain controls from left to right are in the audio, mixer and i.f. circuits. The two toggle switches are in the negative "B" and beat-oscillator filament circuits, while the "A" switch is attached to the mixer gain control. When the drilling is complete, the sheet may be clamped in a vise and bent along the scratched lines. The ¼-inch strips which will be formed along the sides of the chassis effectively prevent buckling of the chassis under pressure.

### Wiring

As soon as the bending operation is finished, the parts may be mounted and the receiver is ready for wiring, all of which is carried beneath the chassis. The view showing the under side of the chassis may look complicated, but it is really very simple. The parts are arranged so that all r.f. leads are short and the remainder of the wiring is simply bunched together wherever possible, reasonably avoiding the forward high-frequency section near the front of the chassis. Most of the resistors and by-pass condensers may be supported between the terminals to which they con-

densers. The two outside condensers are mounted with their shafts or centers 1¼ inches from each edge. If duplicate condensers are used and the front mounting screw holes are drilled 1⅝ inch from the front edge of the chassis, the shafts will extend the correct distance in front of the panel. The coil to the rear of the left-hand condenser is, of course, the mixer coil; the tube is the high-frequency oscillator and the coil to the right, between the two condensers, is in the oscillator circuit. Holes ⅜ inch in diameter should be drilled under the center of each of the i.f. transformers for the leads; four ½-inch holes are required to clear the terminal lugs of the beat-oscillator unit. Clearance holes should also be drilled near the 1H5G socket, the 1A7G socket and near the rear corner of each of the variable condensers for passing connecting wiring. One or two holes may be drilled at convenient points near the rear of the chassis for long bolts to extend through the bottom of the cabinet to fasten the rear end of the chassis down securely in case transportation is necessary.

All tubes fit standard octal sockets; the mixer

◆  
Top view of chassis showing arrangement of units. The chassis is bent from a single piece of ¼-inch aluminum sheet. See text for details.  
◆

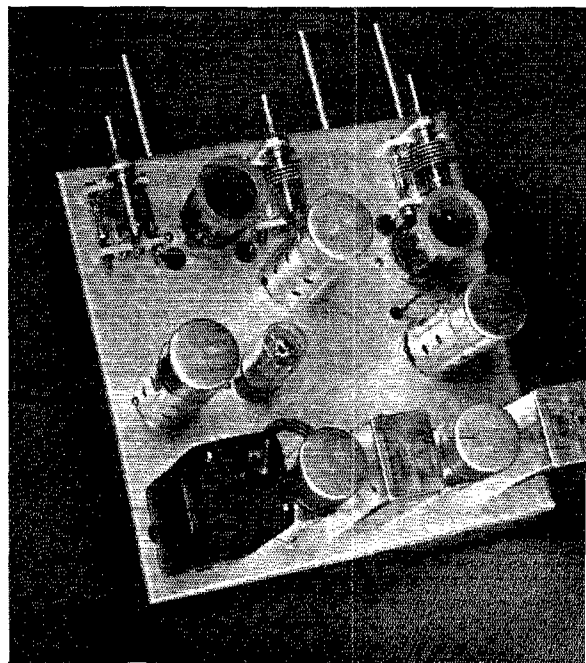

nect by their own connecting wires. Wherever the span is too great, or a loose end must have an anchorage insulated from the chassis, small bakelite terminal strips designed for such emergencies may be used. By-pass condensers should be grounded to the chassis at the nearest available mounting screw. Short pieces of rigid wire are used between the stators of the tuning condensers and the coil-socket terminals underneath. They are protected against accidental short-circuiting against the chassis by rubber grommets fitted into the clearance holes. The oscillator-mixer coupling condenser  $C_{11}$  is supported by its short heavy connecting wires and may be seen near the center of the chassis. The lead between the grid of the 1H5G and its coupling condenser is shielded with copper braid against r.f. and hum pick-up. Later, if a stronger beat-oscillator signal is desired, it may be obtained by forming a small capacity from a pair of short insulated wires twisted together and connecting one end of one wire to the diode plate of the 1H5G and the other end of the second wire to the beat-oscillator grid terminal. It should be remembered that the 'phone jack must be suitably insulated from the chassis. The power-supply wires should be long enough to reach the battery terminals. This length may be determined better after the chassis and batteries are mounted in the cabinet. It will probably be advisable, however, first to test the receiver before fitting it to the cabinet.

### Coils

Coil dimensions may be determined from the data in the coil table. The receiver is designed to cover the amateur bands only and to provide almost full-scale bandspread on each band. Care should be taken to duplicate the dimensions given as closely as possible. In making the bandspread tap, it will probably be easiest to wind the entire coil first, select the turn for the tap and, if necessary, force the turns apart slightly on each side. A small drill may be inserted between the turns to make the hole in the form. The insulation may be removed with the tip of a knife and a wire pushed through the hole from the inside may be soldered to the turn leaving just enough solder to make the joint secure. Scraping only the top of the wire will prevent solder from filling in between closely-spaced turns. The other end of the tap lead is scraped and passed down through the correct pin in the form. All coil windings should be made in the same direction. Approximately  $\frac{1}{8}$ -inch space is left between each winding on the same form. On the mixer form, the antenna coupling coil  $L_1$  is wound at the bottom, the tickler winding  $L_3$  next above it and the grid winding  $L_2$  at the top of the form. On the oscillator form the tickler winding is below the grid winding. It is important, in making connections to the coil sockets and form pins to see that the top end of the grid winding connects to grid, the

lower end of the grid winding to ground (or  $C_2$  in the case of the mixer winding), the upper end of the tickler winding to plus "B" (or the "plate" terminal of the first i.f. transformer in the case of the mixer) and the lower end of the tickler to plate when the coil is inserted in its socket.

A small hole for the lower dial mounting screw should be spotted and drilled in the front edge of the chassis so that the dial may be mounted temporarily while testing before placing the receiver in the cabinet.

### Tuning—I.F. Alignment

The receiver is most easily tuned up with the aid of a modulated test oscillator. If one is not possessed, the next best thing to do is to take the receiver and batteries to a service man and let him align the i.f. circuits to 456 kc. The job shouldn't take more than ten minutes of his time. If a test oscillator is available, it should be set at 456 kc. and its output terminals connected between the grid cap of the 1N5G and chassis with the transformer connecting cap removed. With  $R_3$  set near the ground point,  $R_3$  at full gain toward  $C_{10}$ , beat oscillator off but the rest of the receiver turned on and the headphones plugged in, the secondary, and then the primary of  $T_2$  should be tuned carefully to produce the loudest signal. If test oscillator is not modulated, the transformer may be tuned across the hiss of the test oscillator and set at its center. The test oscillator output should be adjusted frequently to maintain a low signal level for most accurate tuning. With  $T_2$  tuned, the test oscillator output terminals should be transferred to the grid of the 1A7G, removing the cap connection, replacing the normal grid connection to the 1N5G and inserting a coil in the mixer coil socket. After  $T_1$  is tuned in the same manner, it may be advisable to check again the tuning of  $T_2$  with the test oscillator output still connected to the input of the 1A7G. If no test oscillator or service man is available, the original factory alignment will have to be depended upon. Coils for a band in which plenty of activity may be expected should be plugged in and the antenna connected. The 3.5- or 7-Mc. band in the middle of the evening is almost always good for tests.  $C_1$  should be set at maximum capacity.

### Setting the Beat Oscillator

Connect a piece of push-back or other insulated wire to the grid of the 1N5G i.f. amplifier tube and push the insulated portion down between the shield and the tube, taking care that the insulation does not slide back on the wire and allow the lower end to come in contact with the shield. A piece two or three inches long should provide enough feed-back to permit oscillation, indicated by the familiar "plopping" sound, when  $R_3$  is turned near ground. With the i.f. amplifier oscillating, turn on the beat oscillator and turn the

tuning control on the top of the unit until the beat oscillator signal is heard. It should be an unmistakably loud howl.

### Spotting the Band

Now that the beat oscillator is tuned near the correct point, the feed-back wire should be removed from the 1N5G and  $R_3$  set at the ground point.  $C_{14}$  is the oscillator padding or bandsetting condenser. With the bandspread condenser  $C_{13}$  set at minimum capacity, the object is to set  $C_{14}$  to tune to the high-frequency end of the band. When this has been done, the bandspread condenser should tune across the band. Approximately correct settings for  $C_{14}$  are 80, 75, 95, 90

and 45 per cent of the total capacity of the condenser for the 1.7-, 3.5-, 7-, 14- and 23-Mc. bands respectively. If the 3.5-Mc. band is used for the test, the high-frequency edge of the band is most easily located by tuning  $C_{13}$  to minimum capacity and then tuning  $C_{14}$  very slowly from maximum capacity until the 4-Mc. 'phones are heard.

### Tuning the Mixer

During this process,  $R_1$  should be set at about mid-position or one-quarter above ground and  $C_2$ , the mixer tuning condenser rotated frequently to keep this circuit tuned. Correct tuning is indicated by an increase in background noise. If two such spots are found, the correct one is towards

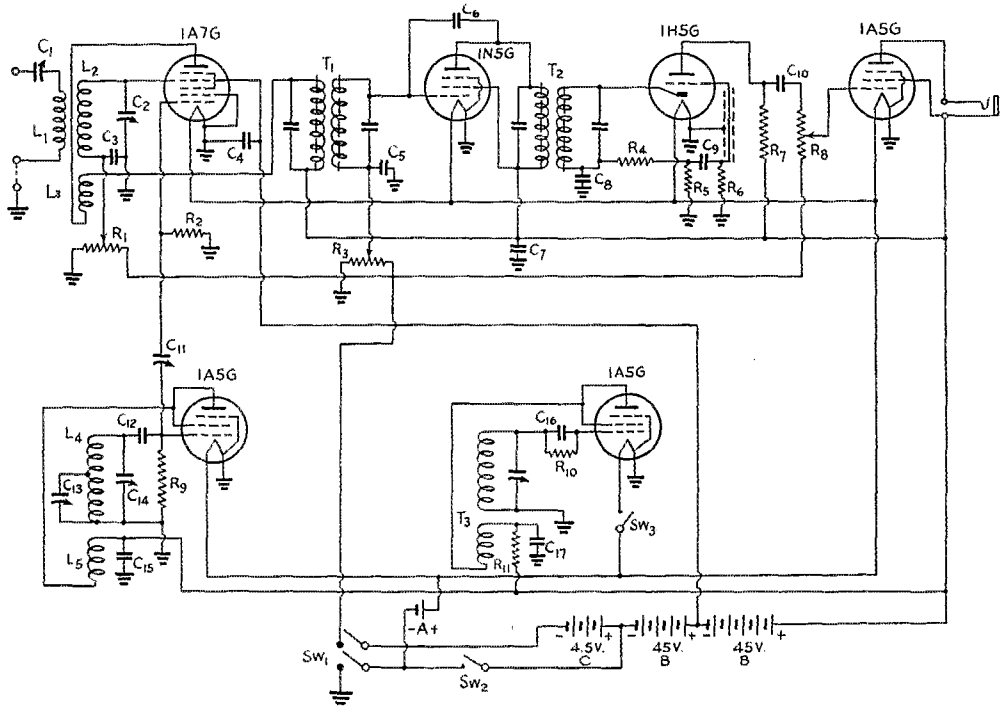

Fig. 1 — Circuit diagram of the battery-operated receiver.

- |  |  |  |  |
|--|--|--|--|
| $C_1$ — 70- $\mu$ fd. mica trimmer (Hammarlund BBT-70).                      | $C_{13}$ — 35- $\mu$ fd. midget variable (National ST-35).                         | $R_4$ — 50,000 ohms, $\frac{1}{2}$ -watt.              | $SW_1$ — D.p.d.t. switch on mixer control. (See $R_1$ .)             |
| $C_2$ — 50- $\mu$ fd. midget variable (National ST-50).                      | $C_{14}$ — 50- $\mu$ fd. midget variable (National ST-50).                         | $R_5$ — 500,000 ohms, $\frac{1}{2}$ -watt.             | $SW_2$ — S.p.d.t. toggle "B" switch.                                 |
| $C_3$ — 0.005- $\mu$ fd. mica.   | $C_{15}$ — 0.01- $\mu$ fd. paper.  | $R_6$ — 500,000 ohms, $\frac{1}{2}$ -watt.             | $SW_3$ — S.p.d.t. toggle, beat oscillator switch.                    |
| $C_4$ — 0.1- $\mu$ fd. paper.  | $C_{16}$ — 0.00025- $\mu$ fd. mica.  | $R_7$ — 100,000 ohms, 1-watt.                          | $T_1$ — Sickles No. 6504 (456 kc.), iron core.                       |
| $C_5$ — 0.1- $\mu$ fd. paper.  | $C_{17}$ — 0.1- $\mu$ fd. paper.   | $R_8$ — 500,000-ohm volume control (Centralab 72-105). | $T_2$ — Sickles No. 6521 (456 kc.), iron core.                       |
| $C_6$ — See text.  | $R_1$ — 5000-ohm potentiometer (Centralab 72-110 with d.p.s.t. switch cover K-12). | $R_9$ — 50,000 ohms, $\frac{1}{2}$ -watt.              | $T_3$ — Meissner No. 6779, air-tuned beat oscillator unit (456 kc.). |
| $C_7$ — 0.1- $\mu$ fd. paper.  | $R_2$ — 200,000 ohms, $\frac{1}{2}$ -watt.   | $R_{10}$ — 50,000 ohms, $\frac{1}{2}$ -watt.           |  |
| $C_8$ — 0.0001- $\mu$ fd. mica.  | $R_3$ — 5000-ohm potentiometer (Centralab 72-110).                                 | $R_{11}$ — 50,000 ohms, 1-watt.                        |  |
| $C_9$ — 0.1- $\mu$ fd. paper.  |  |  |  |
| $C_{10}$ — 0.1- $\mu$ fd. paper.   |  |  |  |
| $C_{11}$ — 30- $\mu$ fd. mica trimmer, Isolantite insulation (National M30). |  |  |  |
| $C_{12}$ — 0.0001- $\mu$ fd. mica.   |  |  |  |

the high-capacity side. Following this procedure, it should not be difficult to locate the 3.5-Mc. band.

### Rechecking I.F. Alignment

When the band has been located, tune down into the c.w. section of the band and pick out a signal of reliable strength and go to work on it. The first step is to check the alignment of the i.f. amplifier, if it has not been previously aligned with a test oscillator. Leaving the secondary of  $T_2$  set, tune the primary carefully for maximum signal. If the alignment throughout is sufficiently good to allow a definite background noise to be heard, adjustments can be most accurately made by tuning  $C_{13}$  to an unoccupied spot in the band and working for maximum background noise. This is done with the beat oscillator off. Now progress to  $T_1$ , adjusting first the secondary and then the primary for best response. Turn now to the mixer adjustment.

### Mixer Regeneration

As mentioned previously, tuning  $C_2$  should produce at least one point of increased response; if two occur, the higher-capacity setting is correct. With the mixer tuned to the correct point,  $R_1$  should be carefully adjusted towards ground. This should cause an increase in response and an increase in i.f. image rejection (rejection of undesired signals at frequencies approximately 900 kc. removed from the desired signal which will also beat with the high-frequency oscillator signal to produce an i.f. signal unless rejected ahead of the mixer tube) until the mixer tube breaks into oscillation. Oscillation should not be permitted; regeneration should be adjusted near the point of oscillation but not so close that other slight adjustments will cause the mixer to break into oscillation. It is possible that oscillation will occur if the mixer is tuned well to the high-frequency or low-frequency side of resonance, sometimes even with the control backed entirely off, but this is of no practical consequence since it should not oscillate at the correct setting. If it is found impossible to stop oscillation at any setting of  $R_1$ , an adjustment of  $C_1$  may remedy the difficulty, otherwise it may be necessary to reduce slightly the size of the tickler winding. On the other hand, if oscillation cannot be obtained, an adjustment of  $C_1$  or a slight increase in the size of the tickler winding should do the trick.

It may be noticed that adjustment of  $C_2$  has some effect upon frequency at frequencies above 7 Mc. This "pulling," often masked by ganged tuning controls, is characteristic of most superheterodynes. If objectionable, it can be minimized by decreasing the capacity of  $C_{11}$ , although best mixer operation occurs at the higher frequencies with  $C_{11}$  at maximum capacity (plates together). Ordinarily, one setting of  $C_2$  will suffice for an ap-

*(Continued on page 108)*

## Splatter

**W**E ADDRESS a plea to that hardy group of individuals who will crowd the last cycle of our band edges during the DX Contest to read "What's Your Crystal Frequency?" with an open mind.

★ ★ ★

*Man biting dog is commonplace compared to a request we had from a member who wanted a two-page write-up of his station in QST and agreed to settle for this at our regular advertising rates!*

★ ★ ★

Make it a solemn duty to read carefully "Resuscitation From Electrical Shock." The Schäfer Prone Pressure Method described is equally effective in cases of gas poisoning and drowning.

★ ★ ★

*What is our policy on Calls Heard? Simply this: When we receive a list of Calls Heard that indicates an unusual and outstanding bit of transmission as well as reception, we'll gladly publish it.*

★ ★ ★

Why is it that ham antenna experiments are conducted in the foulest weather? Our cover shows a composite of T.M.F., author of "Simple Vertical Antennas," at work with complete station set-up at the base of W1SZ's 90' pole. The drab day was not photographic connivery and Tom was caught in a downpour before the rig could be put under shelter.

★ ★ ★

*If you lived in Michigan you would rate your own call for your automobile registration plates! W8NFR sponsored the idea. We are gathering the ramifications and next month we'll tell how he went about it.*

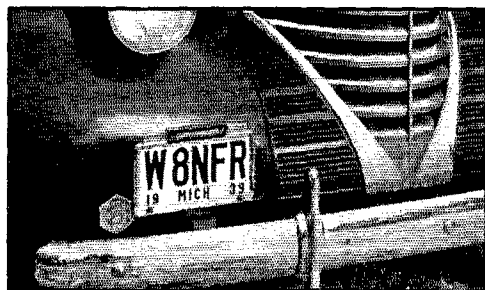

Lew Bellem, W1BES, who installed and operated VR6AY from March 5th to May 5th, will gladly furnish confirmation to any who worked him during those dates, as he has the log. If you haven't received QSL, or if the one received isn't properly filled out, send the dope on QSO to W1BES, enclosing return postage.



# Rescue at 11,000 Miles

## Amateurs Copy QST de XFB8AB

PERHAPS you heard him telling W8CRA and some of the other DX men about it, or perhaps you had to wait until the December issue of QST, to read in "How's DX?" that "FB8AB will be at St. Paul and New Amsterdam Islands signing XFB8AB, so don't let the call bother you." If you're DX-minded, you've kept half an ear out on the 14-Mc. band for XFB8AB; if not, you promptly forgot about him. Perhaps you were interested enough in geography to drag out the atlas and find that St. Paul Island is a barren rock located in the South Indian Ocean at 77° 31' E 38° 43' S and, according to newspaper reports, noted only for bleakness, cold, surrounding waters abounding in lobsters that have long been a challenge to fishermen, and the scene of four unsuccessful fishing expeditions.

Why was well-known F. Paul Bour, FB8AB, going to St. Paul? Perhaps the chance to join an expedition to an uninhabited island was too much lure for a confirmed DX hound, or possibly other factors not so obvious were appealing, but nevertheless Bour joined the de Boers expedition when it put in at Madagascar. It wasn't a particularly wise choice. John de Boers is a Dutchman who last year began dreaming of the fortune in lobsters he might take out of the cold waters at St. Paul and New Amsterdam. According to reports, de Boers deserves no credit for a well-organized expedition — from the start it was poorly supplied and manned. A Newfoundland trawler, *L'île Bourbon*, was transformed into a floating refrigerator, a motley crew assembled, and not enough coal put in the bunkers when the ship left France last May. By the time it reached Madagascar, via the Suez Canal, many of the crew, including the radio operator, had mutinied because of continual fighting among and about the women aboard. At this time Paul Bour joined the crew, to set off for cold St. Paul and the contemplated fortune in lobsters.

At 8:45 on the morning of December 18th, E. R. Gibson, W7DWG of Bremerton, Wash., picked up a weak T8 signal at 7015 kc. calling "QST," and pieced together a strange message:

"QST DE XFB8AB XFB8AB AND PARTY OF 48 ARE STRANDED HERE AT ST PAUL ISLAND AND WILL BE GRATEFUL TO ALL OF YOU TO QSP AS EARLY AS POSSIBLE TO MADAGASCAR THAT WE RAN SHORT OF COAL THRU BAD WEATHER AND WE DID NOT HAVE ANY CHANCE TO FIND COAL AT THE ISLAND WE BEEN CALLING MADAGASCAR BUT NO LUCK OF REPLY WE CAN HEAR TANANARIVO BROADCAST FAIRLY WELL AT 15 GMT SO WOULD LIKE SUGGEST THAT CALL US HERE TOMORROW AND DAYS AFTER WE WILL BE LISTENING FOR ANY MESSAGE OR NEWS HAD PLENTY WORRY SINCE WE LEFT AND HAD MY

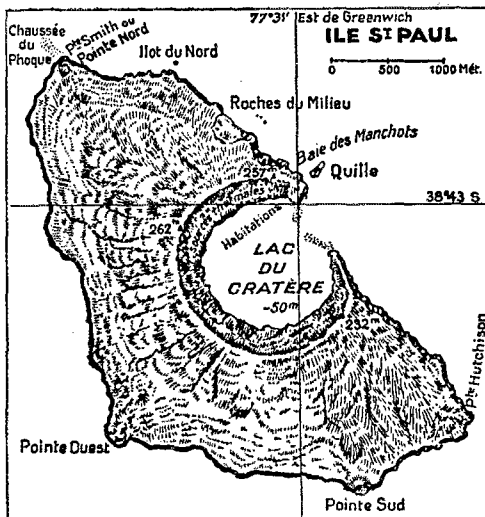

RECEIVER BURNED NOW USING SMALL SCHNELL SET HARD COPY PLENTY QRN KEEP ON LOOK OUT FOR ME AGAIN CONFIRM THAT WE ARE ON STEAMSHIP ILE BOURBON"

After trying in vain to raise XFB8AB, Gibson gave the message to NPC and the U. S. Coast Guard at Seattle by telephone, and, via the Army Net (W7CQI), the French Consul at San Francisco was notified.

On December 19, Neil Taylor, W6MUS at Coronado Beach, Calif., raised XFB8AB at 6:20 A.M. and was told that he was the first station worked by the ship in 33 days. Bour repeated his story to Taylor. Irving Astman, W6OMR, and W7DWG also copied the message. W6MUS assured XFB8AB that he would do everything he could to help, signed with Bour, and then talked it over with W6OMR.

It was decided that since Astman was with the government airways at Norden he was in the best position to give official notification, but apparently he wasn't, and he ended up by buying a 65-word telegram to the Coast Guard at San Francisco, asking that the French Consul and steamship lines be notified. At the same time, the 13th Naval District Commanding Officer had, on W7DWG's request, informed Naval Operations at Washington, D. C., of the situation.

The Navy Department at Washington passed the message on to the French government through official channels. The French government ordered a rescue ship to sail at once from Madagascar. And thus amateur radio supplied the vital link in the chain of rescue from St. Paul to Madagascar via Bremerton, Washington and Paris, France.

That's as far as we go. FB8AB will have to take you the rest of the way, when he returns.

— B. G.

We consider it vital for every amateur to absorb the substance of this article. It may enable you to save a fellow amateur's life. Instructing others about it may save your own. We recommend that amateurs practice artificial respiration upon each other. We commend the subject to the attention of all radio clubs.

# Resuscitation From

**Important Information—**

**BY CLINTON B. DESOTO,\* WICBD**

**S**PEED in applying resuscitative measures is the important factor in electrical shock. Authorities state that 90 per cent of unconscious victims are saved when resuscitation is started within one minute, while but 10 per cent live when there is a delay of six minutes.

Electrical shock ordinarily has three effects:

1. Paralysis of the lower brain halts breathing processes.
2. Circulation is suspended through interruption of nerve circuits controlling heart action.
3. Flesh and nerve tissue is burned along the current path through heating caused by  $I^2 R$  loss in the body.

The first effect is always present where unconsciousness occurs for more than a brief period of time. Shock to the breathing center at the base of the brain renders it incapable of controlling the respiratory system, and breathing stops abruptly. During the cessation of breathing, oxygen must be supplied the body or the victim will suffocate.

It is therefore of the most vital importance that artificial respiration be begun *immediately* after the victim is freed from the contact. *Delay means death.*

By artificial respiration the lungs of the victim are alternately compressed and released, causing air to flow out and in. There are several methods but the one now accepted as most efficient and safest is the Schafer Prone Pressure method. It can be carried on for a considerable period by one person, and — with care — offers no danger to the subject. It is equally applicable in cases of drowning and gas poisoning.

## Procedure

Every amateur should memorize the following rules for procedure in case of electrical accident. Members of the family and associates should be instructed, if only in general terms. The rules

themselves should be copied and prominently posted in the shack.

1. Turn off the current if possible (but don't waste time in fruitless search for the switch). Free the victim from contact with the live conductor as quickly as possible — protecting yourself while doing so. Use a dry non-conductor to pull the body free. The victim's loose clothing (if not moist with perspiration) will serve, if care is taken not to touch metal objects such as buttons, nails in shoes, etc. If the bare skin must be touched before rescue, protect yourself with rubber gloves, your own coat or vest (if dry), etc. Preferably, stand on a board or matting and use only one hand.

2. Immediately after the victim has been freed from contact he should be stretched out on the floor or ground, in a position permitting adequate ventilation. Quickly feel with your finger in his mouth and remove any foreign body (tobacco, false teeth, etc.). Pull out his tongue (with a handkerchief) so it does not interfere with breathing. If the jaws are locked tight do not waste time trying to force them open; this can wait until assistance arrives. The important thing is to commence artificial respiration as quickly as possible; every moment of delay lessens the chance of recovery.

3. Lay the patient on his stomach, one arm extended directly overhead, the other arm bent at the elbow, with the face turned outward and resting on hand and forearm so that the nose and mouth are free for breathing. (See Fig. 1.)

4. Kneel, straddling the patient's thighs, with your knees placed at such a distance from the hip bones as will allow you to assume the position shown in Fig. 2.

5. Place the palms of the hands on the small of the back with fingers resting on the ribs, the

\* Assistant Secretary, A.R.R.L.

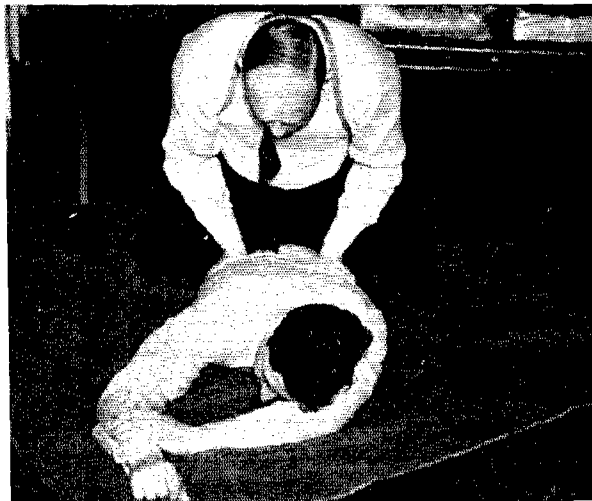

Artificial respiration, as demonstrated by employees of the Hartford Electric Light Co.

Fig. 1, left, shows the position in which the victim's head and arms should be placed. Fig. 2, top right, illustrates the location of the operator's hands and body. Fig. 3, center, shows the end of the downward pressure movement, with the full weight of the operator on the victim's rib structure. Fig. 4, bottom right, is of the end of the cycle, the operator having swung backward snappily, releasing the pressure.

**QST for**

# Electrical Shock

## What to Do and How To Do It

little finger just touching the lower rib. The thumb and fingers should be in a natural position, with the tips of the fingers just out of sight. (See Fig. 2.) Be sure the pressure is on the rib structure and not on the lower organs, or possible injury may result. If properly applied, full force can be exerted on all but the frailest subjects without danger of injury.

6. With arms held straight, swing forward slowly so that the weight of your body is gradually brought to bear on the patient. The shoulder should be directly over the heel of the hand at the end of the forward swing. (See Fig. 3.) Do not bend your elbows. This operation should take two seconds.

7. Now immediately swing backward so as to completely remove the pressure. (See Fig. 4.)

8. After two seconds, swing forward again. Repeat deliberately the complete cycle of respiration and release at a frequency of twelve to fifteen times per minute. As a substitute for a timing count, repeat slowly in synchronism with Movements 6 and 7: "Bad air out. Good air in." The sound of air being expelled will be clearly audible; if it isn't, the tongue or some foreign object is blocking the throat.

9. If another person is present, medical assistance should immediately be summoned. The physician will probably instruct that the fire department be called on to provide an inhalator, pulmotor, etc. If alone with the patient, your only consideration should be to provide artificial respiration. Do not halt this process for the purpose of calling for assistance for at least one hour.

10. Continue artificial respiration without interruption until natural breathing is restored and consciousness regained, or until a physician arrives. In any event continue for at least four hours or until *rigor mortis* sets in. Recovery has been known to take as long as eight hours; under no circumstances despair after working only an hour or so.

11. As soon as assistance is available and *while artificial respiration is being continued*, any tight clothing about the patient's neck, chest and waist should be loosened. Instructions concerning opening the patient's mouth, etc., should be complied with if this has not previously been done. The heels and soles of the patient's feet (shoes on) should be rapped smartly 20 or 30 times with some suitable object. The underside of the arms can be massaged toward the shoulders. During all this, *keep the patient warm*. If the body is wrapped in a blanket, it should be arranged not to hamper resuscitation or breathing. Main-

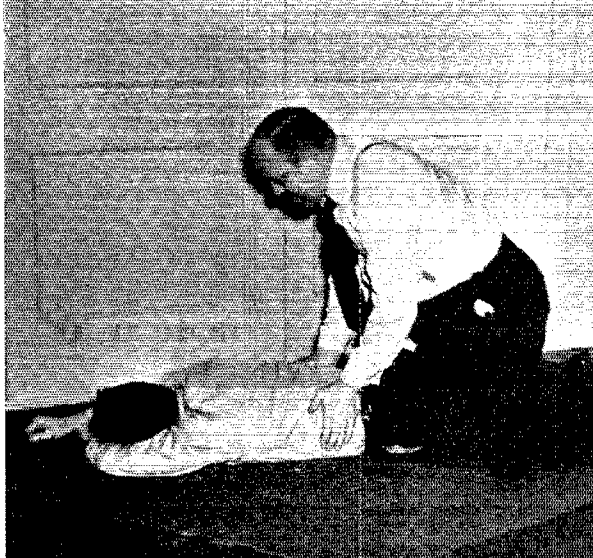

tain free air circulation about the patient's head. Do not administer any liquids whatsoever by mouth until the patient is fully conscious.

12. To avoid strain on the heart, when consciousness returns the patient should be kept lying down and not allowed to stand or sit up. If no physician has arrived the patient should be given a stimulant, such as one teaspoonful of aromatic spirits of ammonia in a small glass of water, or hot coffee or tea. No alcohol should be given. *The patient should be kept warm.*

13. A brief return of natural respiration is not a signal for stopping artificial aid. Rather, the rhythm of the operator should be carefully adjusted to the rhythm of natural breathing. Above all, do not apply artificial respiration too rapidly, or you will defeat the very purpose sought. Artificial respiration should not cease until *consciousness* is regained. Even then the patient must be watched, for he may without warning stop breathing again. Artificial respiration must then be resumed.

14. Under no circumstances should the patient be moved until he is breathing normally of his own volition, and then only in a prone condition. If for some reason earlier movement is unavoidable, resuscitation should be maintained continuously during the process.

15. When it becomes necessary to change operators, as one tires or for some other reason, the change must be made without losing the rhythm of respiration. The two operators should count together, the relief operator taking over during the release period.

### Circulatory System

In most cases of electrical shock the heart action and blood circulation continue. Where the victim is across a high-current source under good contact for an appreciable time, or when his physical condition is not favorable, the heart may suddenly cease to pump blood. Under such circumstances only a physician can render direct aid. The layman can only carry out the instructions given above, depending on the stimulus to circulation to restore heart action.

The patient's color is not a satisfactory symptom of his condition. Victims of shock usually appear blue, although on occasion they may be very white. The body may stiffen and become rigid during the early stages of resuscitation. This condition should *not* be confused with *rigor mortis* and is *not* a signal to stop work; it is purely a reaction to shock, and recovery in such cases has been accomplished.

### Burns

The treatment of burns should be postponed until after respiration has been fully restored.

Two kinds of burns may be encountered in cases of electrical shock. Those due to the passage of current through the body are the most

serious and dangerous, resulting in a searing or cooking of the tissue along the path taken by the current. Since this tissue is burnt and destroyed, it must be replaced, and the healing process is therefore a slow one. Such burns are usually much more extensive internally than they appear on the surface. Competent medical treatment is imperative.

Burns due to electrical flash, r.f., etc., are much more apparent, but they are usually not deep and the injury is largely superficial. The skin will be reddened or blistered in such cases, but little tissue will be destroyed. Emergency treatment is based on the principle that a raw or blistered surface should be protected from the air. Remove the patient's clothing; if it sticks, do not peel it off — cut around it. Saturate such adherent pieces with picric acid (0.5 per cent solution). Apply cotton or other soft dressings to the remaining exposed surfaces and saturate with the same solution. If picric acid is not at hand, use a solution made of one teaspoonful of baking soda to a pint of water. Alternatively, the wound may be protected with vaseline, olive oil, castor oil, clean machine oil, etc. Cover the dressing with cotton, gauze, clean waste, clean handkerchief, etc., held tightly in place with a bandage. Almost any preparation for the treatment of burns can be of some value.

In the case of a dry charred burn, the same type of covering should be lightly bandaged over it, but without wetting the burned region or applying oil to it.

## New Acorn Tubes

THE RCA 957, 958, and 959 are acorn tubes of a new series having low-current filaments of the coated type. These tubes are designed for use by amateurs and experimenters working at the ultra-high frequencies. Their economy of filament and plate power, as well as size, make them particularly useful in compact portable and other battery-operated equipment where size and weight are important factors.

The filament of each of these types can be operated without series resistance directly from a single flashlight dry cell. The filament power required by the 957 or 959 is only 0.063 watt; that required by the 958 is only 0.125 watt.

The 957 is a triode having a moderately high amplification factor. It may be used as a detector, amplifier, or oscillator.

The 958 is a triode especially designed for transmitting service as an oscillator and radio-frequency amplifier. It may also be used as an audio power output tube to operate a sensitive loudspeaker.

The 959 is a sharp cut-off pentode intended for use as an r.f. amplifier or detector. It may also be used as a resistance-coupled a.f. amplifier.

# ★ WHAT THE LEAGUE IS DOING ★

## *League Activities, Washington Notes, Board Actions — For Your Information*

### **ELECTION RESULTS**

**T**HE incumbent directors in the New England and Northwestern divisions were returned to office in the autumn elections of 1938, and new directors were chosen in the Rocky Mountain and West Gulf divisions where the incumbents were not candidates for reelection. An alternate director was also chosen in the Northwestern. The Executive Committee's findings by divisions are as follows:

#### *New England Division*

Percy C. Noble, W1BVR, was returned to office for another two years by a handsome majority:

Mr. Noble.....	394
Raymond W. Woodward, W1EAO.....	227
Clayton C. Gordon, W1HRC.....	91

#### *Northwestern Division*

The Northwestern's director, Ralph J. Gibbons, W7KV, was similarly reelected by a wide margin:

Mr. Gibbons.....	203
A. L. Smith, W7CCR.....	114
Stanley J. Belliveau, W7AYO.....	88

The Northwestern also engaged in spirited balloting for alternate director, the winner being W. N. Wintler, W7KL:

Mr. Wintler.....	156
Niilo E. Koski, W7LD.....	132
Wilbur L. Miller, W7AAN.....	117

Mr. Wintler is a life underwriter for the Northern Life Insurance Company at Eugene, Oregon. In amateur radio since 1919, he has recently served as an assistant director of the Northwestern division, is a past president of the Valley Radio Club and is an O.R.S.

#### *Rocky Mountain Division*

By the narrowest possible plurality, a margin of but one vote, Glen R. Glasscock, W9FA, becomes the new director of the Rocky Mountain, where the incumbent, W9ESA, was not a candidate for reelection:

Mr. Glasscock.....	71
C. Raymond Stedman, W9CAA.....	70

Mr. Glasscock, for many years our S.C.M. for Colorado, is a studio engineer for N.B.C. at Denver. He holds a commission as lieutenant in

the U.S.N.R. and is an O.R.S., O.B.S. and O.O. He was the founder and president of the San Isabel Radio Club and has been in ham radio for over twelve years.

#### *West Gulf Division*

The well-known "Soupy" Groves, W5NW, was not a candidate and the balloting lay between William A. Green, W5BKH, and David H. Calk, W5BHO. Mr. Green won handily:

Mr. Green.....	203
Mr. Calk.....	125

Mr. Green is a district meterman for the West Texas Utilities Company at Abilene and chairman of their safety council in their District A. In amateur radio since 1921 and a former W1, he is an O.R.S. and holds a commission in the N.C.R.

*QST* congratulates the winners in the elections and expresses the thanks of the League to Messrs. Groves and Stockman for their years of service on the Board.

### **K4 CLASS C**

**WE** RECENTLY reported that K4 holders of Class C living in Puerto Rico proper would have to appear for personal examination at San Juan before April 1st. Seems we were wrong about that. F.C.C. intends to permit existing Class-C licenses in P.R. to run their course until it is necessary to modify or renew them, at which time the Class B exam must be taken.

### **2000-2050 KC.**

**B**ECAUSE of difficulty in finding suitable replacement frequencies for services now operating between 2000 and 2050 kc., F.C.C. has experienced delay in shifting our 1715-2000 band to 1750-2050 kc. but still hopes to accomplish it before the winter is over. Good news for 'phone men: When the shift is made, the added kilocycles will be open to 'phone, so the 'phone portion will read 1800-2050 — F.C.C. has assented to this at the request of the A.R.R.L. Board of Directors. One of the emergency calling channels in our new rules now reads 1975-2000 kc., intended to be the last 25 kc. of the 'phone band. When the shift is made, this emergency calling segment will also be altered to 2025-2050 kc.

*(Continued on page 106)*

# A.R.R.L.'s 11th International DX Competition

**Radiotelegraph Contest, March 4th<sup>1</sup> to 12th; Phone DX Contest, March 18th<sup>1</sup> to 26th**

BY F. E. HANDY\* WIBDI

**P**ERIODS for competitive work by either radiotelegraph or radiotelephone operation are again provided. Both come in the month offering the best in DX that the season affords! Rules for contest exchanges will be the same for both periods, except that no quota plan applies in the 'phone period. The quota (See Rule 5) is 3-per-country in the c.w. period, as usual, except it will be "4" for D, G and VK (not VK7). We expect entries to be in one period or the other — but one can take part in both, if he likes. Scores are independent for each period. All reports in the radiotelephone section of the contest must be voice-to-voice. Similarly in the telegraph contest period only telegraph-telegraph QSOs will count.

Now that we have new F.C.C. regulations, that might require the invoking of restrictions in the 3500-4000- and 1715-2000-kc. bands in the event of declaration of a communications emergency, and mindful of the fact that in 1936 we had some degree of QRM between an emergency in one area, and DX operations in the low frequency bands, we are this year modifying the contest so that no contacts made on the 3.5- and 1.7-Mc. bands will count in any fashion. All other bands may be used at will, but not frequencies out of the bands.

## Disqualifications

Disqualifications were made last year and in previous years for off-frequency operation, im-

properly modulated notes, and the like. *Violations of government regulations will again be penalized in this fashion.* Enforcement of sportsmanship as well as the vital duty of the League in protecting amateur rights requires this. Official Observers will be asked to hew to the line, reporting all violations to the contest committee. Two accredited O.O. reports will disqualify. Monitoring cooperation is requested of the F.C.C. itself. Any stations known to have been logged in violations by the F.C.C. during the contest will also be disqualified automatically . . . a single citation only, required. Likewise, WIAW will engage in frequency measuring, to insure fairness to participants and add to the data on which disqualifications are based. The interest of *all* amateurs requires strict observance of frequencies, d.c. power supply regulations, etc.

Amateurs of all nations must work in the frequency bands assigned them or regardless of nationality, must be disqualified if checked in the contest period as off-frequency with sufficient evidence to prove a deviation to the award committee. It makes little difference *what* nationals are out of bounds, we are not going to allow any practices to be built up that would constitute grounds for complaint against the amateur service at the coming Rome conference. The interest of *all* amateurs in their frequency bands<sup>8</sup> are too precious to risk by any yielding to selfish desire of the few to build contest scores by unfair means.

\* Communications Manager, A.R.R.L.

<sup>1</sup> 6:01 P.M., C.S.T., March 4th or 18th, see discussion under "the contest period."

<sup>2</sup> For R-S-T definitions of "readability, strength and tone" in that order: See 1939 A.R.R.L. Handbook, page 405, or Operating an Amateur Radio Station, page 12.

<sup>3</sup> In 'Phone exchanges only two numerals will be given, the first the "readability" and the second the "strength." In other words, telegraph entrants will send and receive *six* figure groups, and 'phone entrants, *five* figure groups.

<sup>4</sup> QHM — Will start to listen at *high* frequency end of band and tune toward *middle* of band.

QMH — Will start to listen in the *middle* of the band and tune toward the *high* frequency end.

QLM — Will start to listen at the *low* frequency end of the band and tune towards *middle* of band.

QLH — Will start to listen on the *high* end of the band and tune toward the *low* frequency end.

<sup>5</sup> Phone operators should *not* use Q code when a few properly chosen words will state where they will be listening first!

The idea also is to make the 'phone report part of the five numeral groups, so it will be quite unnecessary to say "readability" and "strength" or other indication before the first two numbers in the serial number group.

<sup>6</sup> Alaska, Hawaii, Philippine Islands, Cuba, Porto Rico, and Newfoundland, in fact, all localities using PREFIXES other than W or VE will receive QST mention and awards based on their work with W/VE stations.

<sup>6</sup> This QST carries a complete list of the Sections of the A.R.R.L. Field Organization.

<sup>7</sup> Consult the list of call-prefixes for *different countries of the world* as given in Jan. '39 QST, page 62. This will be used as the official list.

<sup>8</sup> Page 21, May 1937 QST discusses this "DX Competition Policy."

The number of scores submitted this year, surviving the handicap of possible off-frequency disqualification for out of band operation, etc. is expected to be used for similarly determining the quotas for different regions in future contests.

## Operating Hints

*Listening* is a first essential. You have to hear them before you can work them. Tuning specifically "from the middle to the end" as well as "from either end toward the middle" should be a useful practice. Crowding the band edges is just an invitation to be disqualified! Operating points, personal efficiency, and the "man behind the station" (most of all) count! W/VE hams not wanting to show themselves "lids" will avoid all use of "CQ DX." No distant stations will waste time answering such calls when one call from "outside" will bring hundreds of answers from more efficient operators. All stations should try to work BREAK-IN for real operating efficiency. Hams outside W/VE urge more speed, asking W/VEs to shoot the number along first before anything else. U. S. and Canadian amateurs approve continued use of CQ by all stations in remote localities, but plead that these CQs be made short — with so many U. S. A. — Canadian stations competing for each one! *CQ DX is "out" for W/VEs.* Remotely located participants: Please sign often in CQs or calls. Use QHM, QML, QLM, QMH<sup>4</sup> for each sub band segment as a calling indicator.

## General Contest Plan

Operators with the prefixes W and VE will be taking part in a QSO Party with amateur stations in all parts of the world. When they effect DX QSOs, they will exchange self-assigned serial numbers (two<sup>2</sup> or three-figure reports plus three self-assigned numbers that stay the same for all stations). This whole group is entered in the contest report. From this record each station will submit its score. From the scores (which the Contest Committee will verify by cross-examination of logs) the winners will be determined for each locality, and certificates awarded. Three points can result from a full exchange in any band, but no more can be obtained from the same station unless both stations connect in another band for additional exchanges. (No 1.8- or 3.5-Mc. band work counts at all, of course.) Contacts with non-participants can count. Where you explain the system, refer to this announcement if necessary, and the operator assumes (and sends you) a serial number for his records and your report.

Those amateur stations outside<sup>5</sup> the U. S. and Canada will try to work as many W and VE stations as possible to exchange serial numbers. Stations in all localities need only take part on the dates announced and report results at the end of the tests to receive credit in *QST*, and be eligible for awards.

Each operator's main competition comes from amateurs in his immediate A.R.R.L. Section in the case of W and VE stations,<sup>6</sup> and in the case of all other amateurs it comes from the individual operators in their country or locality using the same prefix.<sup>7</sup> The W/VE awards are for the operator running up the best record for each Section under the Rules. Comparison of scores between remote Sections and points is not indicative because of the different conditions under which stations work.

Separate certificates will be awarded the c.w. winner and the 'phone winner, for each country, and likewise for each A.R.R.L. Section. It's a chance for 14- and 28-Mc. 'phone hams to do their stuff in the second period — but it will in no sense be a competition of 'phone with c.w. operators. *Select either period; try your luck and DX, and report results!*

Mark first period logs "C.w. station work," and those for the second period "'Phone work." The transmitter must be

**Use Any Bands above 4 Mc. — Certificates to C.W. and 'Phone DX (Section 6) Winners — Swap Number Groups (RST<sup>2</sup> Report<sup>3</sup> — Self-Assigned Serial Nr.) in DX QSOs — Operating Time 90 Hrs. in the 9 Days — Score is the Sum of DX Contact Points Times Official Countries Worked (or Number W-and-VE Districts) — Gavel Trophy to Leading Club! — W-VEs Invite All the World to Take Part.**

kept on c.w. or 'phone, too. It is unethical to shift to c.w. to call a station, or send numbers, when taking part in the 'phone period (and vice versa), and disqualification will be made of offending stations. Likewise, whistling of code for numbers (or similar means) is regarded as improper. Counting of consecutive numbers, spelling of the letters that constitute numbers, using word lists from the Handbook, etc., are regarded as the proper methods.

## The Contest Period

The exact local starting and ending time for our DX competition is given in the table below. These times are based on "Greenwich," and should be computed by any part of the world from the Greenwich meridian. The contest runs (First Period) from Saturday March 4th, through Sunday, March 12th (until Monday March 13th, G.T.); and (Second Period) from Saturday, March 18th through Sunday, March 26th (until Monday, March 27th, G.T.).

## Serial Numbers

The first digits of the serial number sent shall constitute the Readability<sup>2</sup> — Strength<sup>3</sup> and Tone<sup>3</sup> reports of the station to which the number is sent. Every operator taking part in the contest assigns himself a distinctive three-numeral group, used by him throughout the contest as the last part of each number exchanged (sent). Try to send and receive one complete serial number with each DX station.

## Time Limit

For 90 hours' total contest operation or less (for either period) there is no penalty, and nothing to do when computing your score. Should you operate 100 hours (for example), your gross score should be multiplied by the fraction 90/100 to give your net or "corrected score." This plan permits the average ham to plan for his working day for meals, for 8 hours daily sleep, etc. Cross examination of logs makes it possible to check the operating time submitted as may be necessary, of course. Keep track of the time you start and stop operating your station. This must be shown in your log report. What constitutes "contest operating hours"? Not hours keeping local skeds within the U. S. A. and Canada. Not time spent in local rag chews, swapping DX results. If you listen for DX with the ability to call DX stations when you hear them, *that time counts*, whether you do any calling or working or not. The whole period is to be charged against "contest operating time," not just the time after you started transmitting! Be properly sporting and fair in entering your time on the air.

Time	Starts	Ends
	<i>March</i>	
Greenwich . . . . .	4th 18th 0001 (12:01 A.M.)	12th 26th 2359 (11:59 P.M.)
A.S.T. . . . .	3rd 17th 8:01 P.M.	12th 26th 7:59 P.M.
E.S.T. . . . .	3rd 17th 7:01 P.M.	12th 26th 6:59 P.M.
C.S.T. . . . .	3rd 17th 6:01 P.M.	12th 26th 5:59 P.M.
M.S.T. . . . .	3rd 17th 5:01 P.M.	12th 26th 4:59 P.M.
P.S.T. . . . .	3rd 17th 4:01 P.M.	12th 26th 3:59 P.M.

### Awards

Certificate awards will be given: (1) Two in each remotely located country<sup>7</sup> — to one c.w. winner, and one 'phone winner. In either contest section, all hams in the one territory defined in the official country list compete for an award. (2) Two certificates likewise will be awarded in each of the 67 A.R.R.L. Sections of the mainland U. S. A. and Canada one to the telegraph, and one to the voice-operated station winner.

All operators in the same country<sup>7</sup> will be in competition with each other — and similarly each A.R.R.L. section-boundary circumscribes a competing group. DX-transmis-

sion characteristics being the same for all operators in each award-area, and in each period, the chances of being a winner depend on operating ability and stations and are equally fair to all.

### Club Participation

To encourage local participation additional certificate awards (besides the A.R.R.L. Section awards) will be made through each club where three or more individual club members, or local hams invited by such a club, take part. For a club to rate a c.w. winner's certificate award on behalf (Continued on page 110)

#### LOG, 11th A.R.R.L. INTERNATIONAL RELAY COMPETITION (Example, W6ZAA Serial No. 645)

C. W. Entry March 4th-12th

(Logs from W or VE, show, for each band)

Call Signal .....  
 Name .....  
 Address .....  
 Transmitter Tubes .....  
 Plate watts (input last stage) .....  
 Nr. Hours Station Operation<sup>9</sup> (17 h. 28 min.)  
 A.R.R.L. Section (for W/VE's) .....

Bands	7	14	28 Mc.	Total	Different Stations and Countries
Nr. DX Stations QSOed	3	5	1	9	9
Nr. Countries <sup>7</sup> QSOed.	2	4	1	7	6

(Logs from remote points indicate for each band in this part of the log "Nr. W/VE sta. QSOed . . ." and "Nr. U.S.A.—Canada licensing areas worked. . . ." in a similar tabulation.)

Station Time Record	Operating Time <sup>9</sup>	Date and Time	Station Worked	Country	Worked Record of New Countries <sup>10</sup> for Each. Freq. Band			Serial Numbers		Points <sup>11</sup>
					7	14	28	Sent	Received	
On 4:01 P.M.		Mar. 3rd 4:02 P.M. P.S.T. (or 0002 G.T. Mar. 5th) 7:15 P.M. P.S.T. 9:40 P.M. P.S.T.	G6NF  G2MI PA0AZ	G.B.  G. B. Netherlands		1  1 <sup>10</sup> 2		568,543  488,543	478,001  578,988 488,111	3  2 3
Off 10:00 P.M.	5 h. 59									
On 7:00 P.M.		Mar. 6th 7:38 P.M. 8:50 P.M. 11:50 P.M.	VK2TI ZLIMR J3FJ	Aust. N. Z. Japan	1 2		3	579,543 487,543 349,543	579,287 398,657 588,984	3 3 3
Off 11:55 P.M.	4 h. 55									
On 12:00		Mar. 12th 12:05 A.M. P.S.T. 3:10 A.M. P.S.T.	VK2RA VK5FM	Aust. Aust.	2 <sup>10</sup>		1	586,543 499,543	577,000	3 1
Off 4:05 A.M.	4 h. 05									
On 1:30 P.M.		2:00 P.M. P.S.T.	PY2AC	Brazil		4		487,543	468,852	3
Off 3:59 P.M.	2 h. 29									

17 h. 28<sup>9</sup>

Multiplier = 2 + 4 + 1

24<sup>11</sup> × 7 (countries) = 168 score

I hereby state that in this contest, to the best of my knowledge and belief, I have not operated my transmitter outside any of the frequency bands specified in, or in any manner contrary to, the regulations my country has established for amateur radio stations; also that the scoring points and facts as set forth in the above log and summary of my contest work are correct and true.

.....  
 Signature of operator(s)

<sup>9</sup> Add second column in log to give total operating time.

<sup>10</sup> "Countries" for W/VE Participants. Change to read "Districts" or "Licensing Areas" on all reports from other parts of the World. A progressive record of the number of new countries (or licensing areas) is kept in these columns. A notation is made for each station worked but the figure increases numerically only as additional prefixes (or lic. areas) are added on a certain band. The last number notation in each column added to similar numbers in other columns gives the "multiplier." Counting the "number of notations" in each of these columns gives the number of different contacts on each band for information for the log heading.

<sup>11</sup> Total "Points" multiplied by the number of

(1) Countries or localities (prefixes) for all bands or

(2) U. S. and Canadian licensing areas for all bands equals the SCORE . . . . . (This is the final score unless the operating time exceeds 90 hours.)





# H A M D O M



**T**HERE has been a persistently recurrent rumor in Hamdom in recent years. One ham would say to another, "Didja hear that Amos of 'Amos 'n' Andy' is on the air with a ham rig?" "Bzzz bzzz bzzz." "Yeah, got his ticket last month, I hear." And then there would be a check-up, and the rumor would be disproved, and that would be that.

But the fact that these rumors kept recurring indicated that there must be a little fire under the smoke — that, if nothing else, Amos could occasionally be found sitting in at some ham shack. Now, however, truth has overtaken rumor, and, quite without general fanfare, Freeman F. Gosden ("Amos" every evening on your b.c.l. set) is on the air from his Beverly Hills home with the call W6QUT.

It started about the first of November, when illness confined Gosden to bed at all times except when he was actually on the air. He got hold of a young ham in Los Angeles named Raymond Grammes. Gosden studied code with Grammes three hours a day for two weeks, and on the fourteenth day he took the examination and passed — with a high mark, incidentally.

This was not Freeman Gosden's first experience with radio, or even with the license examination. He was a radio operator in the Navy during the War, stationed at WQV at Virginia Beach. He went through the radio school at Cambridge. Although active in the broadcasting end of radio practically to the exclusion of other activities for twelve years, a yen to rejoin the ham ranks had been in his mind for the past five years. The two weeks' practice with Grammes brought back his old code knowledge. The toughest part, of course, was to brush up on modern radio theory and regulations. Since it is a characteristic of Gosden to be expert in every pursuit he undertakes, he did a thorough job in training himself for the examination.

The layout at W6QUT (in case you don't get a chance to ask over the air!) is a kilowatt rig built to Gosden's specifications by Forrest Wright, W6LFC. A custom-built job was dictated by the

strenuous daily régime that Amos 'n' Andy undergo, confining them either to the broadcasting studios or the office where they write the material for their daily episodes except for odd moments between broadcasts and during the late evening. A "General" rotary beam with both reflector and director is rotated by motor and compass at a point three hundred feet from the transmitter.

Amos hopes to enjoy many QSO's with fellow hams around the country. He's still a little mike shy — despite twelve years of Amos 'n' Andy broadcasts, he claims he is still nervous about going on the air over a ham rig! — so take it easy, gang. You know, in some ways it's harder to be an amateur than a professional — even for a top-ranking professional who is one of a team that, according to N.B.C.'s publicity staff, has "from their own imaginations and two speaking voices created a little world of mythical characters whose humorous, human ways are known to a nation and whose malaprops have become a nation's slang."

What does Andy think of it all? Well, he's not a ham yet, but it looks as though he were on his way. At least, he has a radiotelephone license under which he operates the transmitter in the Stinson *Reliant* which he flies in and around Southern California. That the Amos 'n' Andy establishment as a whole is thoroughly saturated with amateur radio is evidenced by the fact that Amos' Christmas gift from their capable secretary, Louise Summa, was his A.R. R.L. membership entry.

Turning now from radio matters, Gosden's background is a colorful one. Born in Richmond, Va., in 1899, he was schooled at Richmond and Atlanta. Brief experiences as a salesman of tobacco and later of automobiles were interrupted by the World War and Navy radio. In 1920 he joined a firm which staged amateur theatricals around the country, working as a director of home talent productions. It was on this job that he met Correll. As "Sam 'n' Henry" over WGN and then later as "Amos 'n' Andy" on N.B.C. — the first daily 15-minute network show on the air — they established many records.



It's "W6QUT 'n' Andy" now. "Amos" — Freeman F. Gosden, right, above — joined the ham fraternity with a new kilowatt job along about Christmas time.

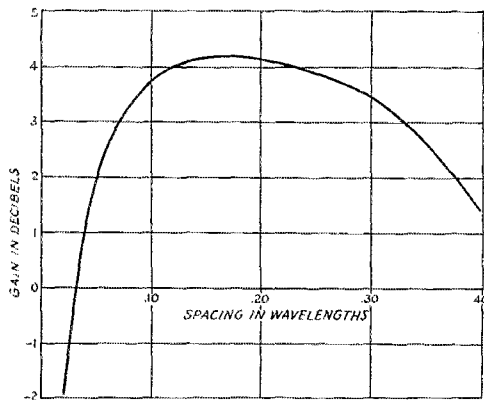

Fig. 1 — Gain in db versus spacing in wavelengths for two parallel half-wave antenna antennas fed out of phase. Gain is referred to a single half-wave antenna.

# The "Q" Beam Antenna

BY LLOYD W. OLANDER\*

## A Two-Band Directional System With Non-Resonant Feeders

IN GENERAL, a fixed antenna should have vertical and horizontal characteristics which give optimum results over a wide range of distances and directions. Antennas such as the single long-wire radiator, the "V," and the horizontal diamond restrict the radiation in the horizontal plane so that one or more sharp lobes having fairly high gain are produced. However, 15 to 20 degrees removed from the beam the signal strength is down several "S" points. To meet the average amateur requirement of wide-range long-distance transmission on the higher frequencies, the antenna should have a broad horizontal characteristic and low-angle vertical directivity, unless the system is rotatable or there is sufficient room for several antennas having sharp horizontal beams.

An antenna approaching these specifications has been developed by G. H. Brown.<sup>1</sup> Basically, it consists of a pair of closely-spaced elements excited with currents 180° out of phase. The resulting radiation is maximum in the plane of the elements and broadside to them, when the spacing between the elements is 0.5 wavelength or less. The maximum gain is essentially constant for spacings between 0.125 and 0.20 wavelength. The curve of Fig. 1 shows the variation of gain with spacing for a two-element beam antenna where each element is one-half wavelength long (equation 50 of Brown's article). The radiation pattern may be shifted either by changing the spacing of the elements, the phase relation between the excitation currents, or the electrical length of the elements.

\* Chief Engineer, E. F. Johnson Company, Waseca, Minnesota.

<sup>1</sup> G. H. Brown, "Directional Antennas," *Proc. I.R.E.*, Jan., 1937.

### The "Q" Beam

The "Q" beam antenna, Fig. 2, is a two-band matched impedance antenna for two adjoining harmonically-related bands. It consists of two half-wave radiators spaced  $\frac{1}{2}$ -wave apart and fed 180° out of phase by means of individual quarter-wave "Q" sections. The radiation pattern is bi-directional, maximum broadside to the radiators, and has a fairly wide horizontal angle. The gain over a half wave is approximately 4 db on fundamental operation and over 6 db on second harmonic operation.

Since the voltages or currents on opposite conductors of a balanced open-wire line are 180° out of phase, the 180° phase relation between the two elements is obtained very simply by reversing the connections at the center insulator of one element. Thus the right half of one element and the left half of the other element are connected to the right-hand tubing of the associated "Q" sections, and vice versa. The two "Q" sections are fed by a 600-ohm balanced two-wire transmission line. The bottom connection between the two sections should not be more than one or two inches at frequencies above 56 megacycles. At the lower frequencies this connection is not so critical, but should be as short as possible.

When two antennas or elements are so spaced as to have appreciable mutual reactance, the resistance and reactance of each antenna (as measured at a current loop) and the gain of the system will change with the spacing and the electrical length of the antennas. It is apparent that as the spacing approaches zero the mutual impedance approaches the self-impedance of each antenna and the directivity is the same as for one radiator alone, while at a very great spacing the mutual impedance is negligible.

The self-impedance of a half-wave horizontal

radiator is  $73.2 + j42.5$  ohms.<sup>2</sup> This result indicates the necessity for decreasing the length a little (5 per cent)\* to obtain a non-reactive load. The inductive reactance of each half-wave element, when two elements spaced 0.2 wavelength are used, increases from 42.5 ohms to 56.8 ohms. This increase in inductive reactance was verified during testing of the "Q" beam, as it was found necessary to decrease the length of each half-wave element to 94 per cent of the length in space instead of the usual 95 per cent.

With fundamental operation the radiation resistance at a current loop decreases from 73.2 ohms to approximately 21 ohms, which was determined by evaluating equations 33 and 34 of Brown's article. The proximity of surrounding objects and the height of the antenna will change the value to some extent. The radiation resistance of the elements will be equal only when  $0^\circ$  or  $180^\circ$  phasing is used and the power is divided equally between the elements.

### The Matching Section

The "Q" sections, a quarter wavelength long, which feed the individual half-wave elements at a high-current point, must match the 21-ohm impedance at the center of the elements to 1200 ohms at the opposite end of each "Q" section. The 600-ohm transmission line is then correctly matched, since the two "Q" sections are connected in parallel.

By solving the following equation:

$$Z_o = \sqrt{Z_A Z_L}$$

where

$Z_o$  = Characteristic impedance of "Q" sections

$Z_A$  = Resistance of each half-wave element (21 ohms)

$Z_L$  = Twice characteristic impedance of transmission line (1200 ohms)

it is found that the "Q" section characteristic impedance must be 158 ohms. The characteristic impedance of a "Q" section having  $\frac{1}{2}$ -inch conductors spaced 1 inch center to center is 158 ohms. It may be computed from the formula

$$Z_o = 276 \log_{10} S/d + \sqrt{\frac{S^2 - 1}{d^2}}$$

where

$S$  is the distance between centers of the conductors (1 inch)

$d$  is the diameter of the conductors ( $\frac{1}{2}$  inch)

<sup>2</sup> P. S. Carter, "Circuit Relations in Radiating Systems and Applications to Antenna Problems," *Proc. I.R.E.*, June, 1932.

Except in the case of large long-wire antennas (the "V" or diamond) harmonic operation of an antenna entails the use of tuned feeders, since the ordinary impedance-matching systems go badly out of adjustment when the frequency is doubled. Here is a scheme which permits two-band operation, at least, with the transmission line closely matched on both bands. The radiating portion resembles the popular W8JK arrangement, giving low-angle radiation with a rather broad horizontal beam.

### Second Harmonic Operation

When the antenna is operated on the second harmonic it becomes a two-section system, since the electrical length doubles and each element now consists of two half-wave sections fed at the ends (high-voltage points). Since the half-wave sections in one element connect to opposite sides of the "Q" matching section, they are effectively fed in parallel but  $180^\circ$  out of phase. The electrical spacing between the two elements also becomes twice as great and increases to 0.4 wavelength.

There is an interesting change in the matching characteristics of the "Q" sections, which become  $\frac{1}{2}$  wavelength long at the second harmonic. A line which is exactly  $\frac{1}{2}$  wavelength long has identical voltage-current relationships at each end, regardless of the characteristic impedance. Since an impedance is simply the ratio of voltage to current at a point in a circuit, the  $\frac{1}{2}$ -wavelength line therefore has the relation

$$Z_L = Z_A$$

and the property of one-to-one transformer. If the line is terminated at either end by 600 ohms, for

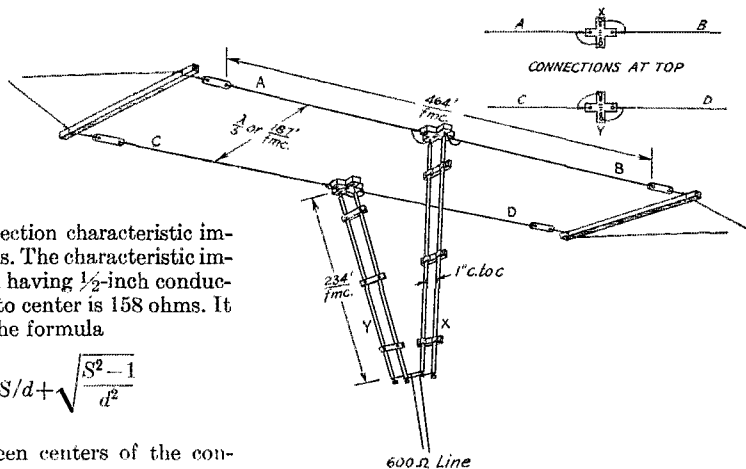

Fig. 2 — The "Q" beam antenna, using two "Q"-bar matching sections to feed out-of-phase antenna elements. The 600-ohm line will be closely matched at the termination on both fundamental and second harmonic of the system.

example, measuring equipment will indicate 600 ohms at the opposite end.

The impedance to ground at the end of a half-wave antenna is approximately  $2200^3$  to  $2900^4$  ohms<sup>5</sup> and, disregarding the mutual coupling, it is to be expected that since the two half-wave sections of each element are connected in parallel

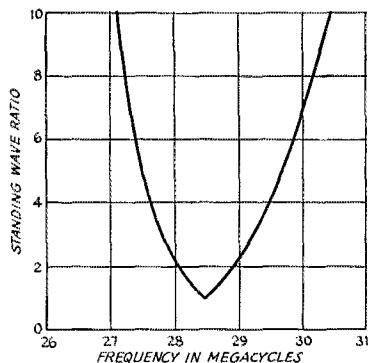

Fig. 3 — Standing-wave ratio on the 600-ohm transmission line plotted against departure from resonance of a "Q" beam designed for a fundamental of 28.5 Mc. The mismatch is small over the low-frequency half of the band.

the impedance at the high voltage point where the "Q" sections are connected will be around 1200 ohms. The 1200-ohm load is reflected through the half-wave "Q" section, which means that the impedance at the transmission-line end of the "Q" section is identical to the impedance at the antenna end. Since the two 1200-ohm impedances are connected in parallel at the ends of the "Q" sections, the 600-ohm transmission line is again terminated in its characteristic impedance. It is probable that the impedance of each half-wave element due to the mutual coupling of the other three elements changes, although a satisfactory mathematical solution was not obtained. The standing-wave ratio on a transmission line for second harmonic operation was 1.4 to 1, which indicates that impedance at the center is not far from 1200 ohms.

The radiation resistance of each half-wave section at the second harmonic increases from  $2\frac{1}{2}$  to 3 times the value at the fundamental due to the increased spacing.

<sup>3</sup> *The Radio Antenna Handbook*, second edition.

<sup>4</sup> *Electronics*, Aug. 1935 (calculated from information available).

<sup>5</sup> The literature shows no general agreement on this figure, probably because it is subject to considerable variation with local conditions. It has been placed as high as 12,000 ohms (Romander, *QST*, June, 1938). In any event, when several closely-associated antenna elements are concerned the impedance between any two adjacent antenna ends depends principally on the mutual impedances between elements. In the practical case considered here the mismatch is small, which is the important thing regardless of whether or not the assumptions are valid. — *ERROR*.

### Effect of Frequency Shift

Because of QRM conditions, variable-gap crystal holders and variable frequency oscillators often are employed to change the transmitter frequency, thus permitting a satisfactory QSO. With this thought in mind, the curves of Figs. 3 and 4 were taken. These curves indicate the standing-wave ratio on the transmission line as the frequency is varied from the resonant frequency of the antenna. Referring to Fig. 3, for fundamental operation (28 Mc.), the transmitter frequency may be varied over a band of 0.5 megacycle on either side of the resonant frequency with satisfactory results. This curve is rather sharp because of the low resistance of each element. As the antenna resistance is increased the curve becomes broader, which is verified by the curve Fig. 4, for second-harmonic operation. The standing-wave ratio was indicated by a sensitive thermocouple meter connected in a tuned circuit and coupled to the transmission line by a single-turn loop. The entire assembly was mounted on the

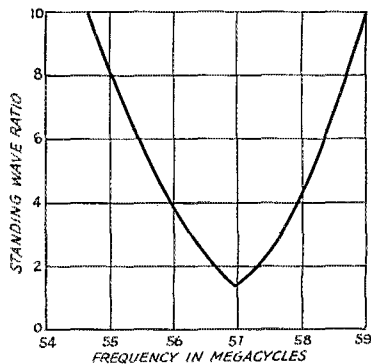

Fig. 4 — Standing-wave ratio with changes of frequency when the antenna is operated at twice the fundamental frequency.

end of a bakelite rod and the coupling held constant by means of an insulated hook.

The ratio of maximum to minimum current or voltage on a mismatched transmission line is proportional to the ratio of the load impedance to the surge impedance of the transmission line. Thus a standing-wave ratio of 4 means that the load resistance  $Z_L$  is either four times or one-fourth the surge impedance  $Z_0$  of the transmission line. Mismatching a transmission line by a certain impedance and then by the reciprocal will displace the maxima and minima of current and voltage by  $180^\circ$ . Thus in the former condition a maximum current indication will be found at the same position as minimum current in the latter case.

Whether the load impedance presented by the "Q" section to the transmission line is higher or lower than the characteristic impedance of the

transmission line can be determined readily by means of a low-scale r.f. meter or neon bulb which is moved along the wire from the junction of the transmission line and the "Q" section toward the transmitter. If the load impedance is low the meter reading will decrease or the neon bulb become brighter as they are slid along the line. For a higher load impedance, the indications will be reversed.

It is general practice to attempt to fulfill the condition  $Z_L/Z_0=1$ . At this condition the line copper loss is minimum. The power lost in a well constructed line, when  $Z_L/Z_0=1$ , is a very small percentage of the power delivered to the load. Considering a 600-ohm line of No. 12 copper wire 100 feet long, terminated in its characteristic impedance, the power at the receiving end will be approximately 97 per cent of the power delivered to the transmission line at 14 megacycles. Fig. 5 compares the power losses in unmatched and matched transmission lines for various ratios of mismatch.<sup>6</sup>  $P_m$ =the power lost in the line when  $Z_L/Z_0=1$ ;  $P_{um}$ =power lost in the unmatched line when the same amount of power is delivered to the load as in the matched case;  $Z_L$ =load impedance;  $Z_0$ =transmission line impedance. When the transmission line is mismatched as much as 2 to 1 the increase in power loss over the matched condition is negligible. A mismatch as much as 4 to 1 can be tolerated. The foregoing discussion applies only to the power dissipated in the copper losses and neglects the radiation losses. A properly-balanced transmission line will radiate a small amount of power, which is increased if the transmission line is not balanced.

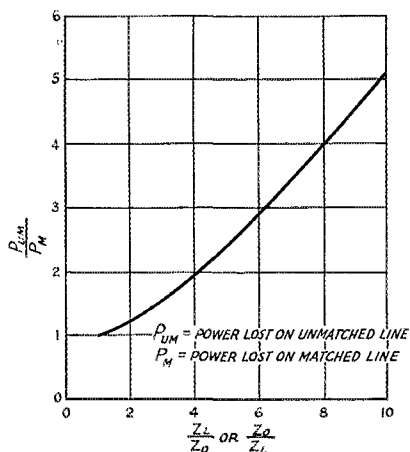

Fig. 5 — Power loss ratio in a transmission line as a function of the extent of mismatch between line and load; radiation losses not included. Constant power in load.

<sup>6</sup> From an unpublished paper by G. H. Brown.

The maximum radiation from the "Q" beam is at 90 degrees to the axis of the radiators in the horizontal plane. The nulls off the ends (along the line of the antenna) are very pronounced. On the second harmonic, the gain over a single half-wave antenna is still 5 db 15 degrees off the line of maximum radiation, as compared with over 6 db in the optimum direction; on the fundamental, the gain is still 3 db at 30 degrees from the maximum, or only 1 db down. The useful width of the beam is probably about 35 degrees in each direction broadside in the former case, and about 70 degrees in the latter.

The radiation in the vertical plane varies with the height above ground, but with the "Q" beam is maximum at a lower angle than in the case of a single half-wave antenna because of the out-of-phase currents; the antenna may be placed at heights of a half- to a full-wave above ground with satisfactory results. The lower angle of radiation results in more consistent DX reports. A "Q" beam has been used at W9LFU for almost a year with excellent results.

The "Q" beam can be operated on the fourth harmonic although the gain is reduced due to the wider spacing (0.8 wavelength) of the elements, and it is probable that the radiation pattern is multi-lobed. Each element then consists of two full-wave sections fed at the ends. The end impedance to ground of a horizontal full-wave antenna is of the same order as that of a half-wave antenna, and it is to be expected that the impedance at the receiving end of the "Q" section will be in the neighborhood of 1200 ohms.

Since the "Q" sections at the fourth harmonic have an electrical length of one wavelength, they function as two one-to-one transformers in series. The 1200-ohm impedance, therefore, is reflected to the transmission line end of the "Q" section as explained under second harmonic operation. Fourth harmonic operation was not attempted, and no calculations were made of either the gain or field pattern.

#### Acknowledgment

Considerable credit is due Fred Hager, Jr., W9DRG, for doing the experimental work, checking the original calculations and determining the radiation patterns.

### **Straits**

— Said the electron to the amplifier grid,  
"Greetings and excitation." — W4DZB

According to a news item found by W1KTX in a small Mass. newspaper, one of the local citizens "was recently granted a license for an amateur broadcasting station and assigned a wavelength for his special use."

No poaching, boys!

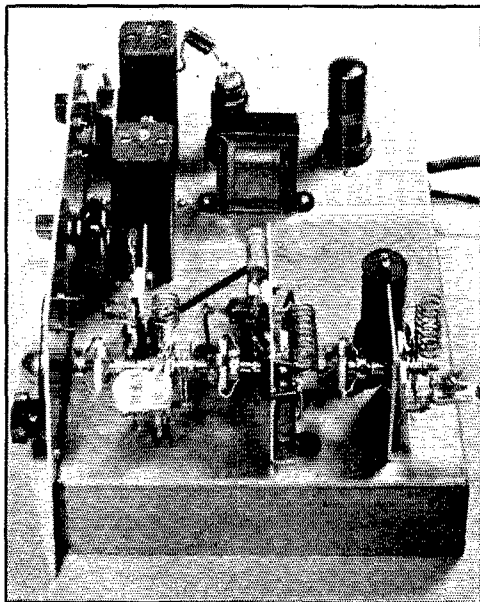

◆  
 Details of construction of the r.f. section are shown in this end-on view of the receiver.  
 ◆

## Modernizing the 56-Mc. Receiver

★  
 BY JACK WAGENSELLER,\* W3GS  
 ★

### *An Economical 56-Mc. Superheterodyne Receiver of Excellent Performance*

**T**HE shortcomings of the popular five-meter superregenerative type receiver are no doubt realized by every amateur using a receiver of that type. It is unselective, generates an extremely undesirable background hiss, prevents the reproduction of good audio quality and in most cases re-radiates, causing interference to all nearby amateurs operating in the same band. On the other hand, the superregenerative receiver has always been very popular on the 56-Mc. band because of its simplicity of construction, good sensitivity, low cost, and last but not least, its capability of receiving the broad, frequency-modulated signals so prevalent in this band in the past.

Now that the day of unstable 56-Mc. signals is at an end, so must the day of the 56-Mc. superregenerative receiver, with its many disadvantages, come to an end. With this idea in mind, the writer set out to design and construct a five-meter superheterodyne receiver which would be so far superior to the superregenerative receiver as to eliminate all reasons for existence of the latter.

\* Herbach & Rademan, Inc., 522 Market St., Philadelphia, Pa.

<sup>1</sup> The superregenerative receiver also has the feature of discriminating against spark interference such as that generated by automobile ignition systems. However, it does not appear that this sort of interference is appreciably worse on 56 Mc. than on 28 Mc. (the peak seems to be in the neighborhood of 40 Mc.), and it can be controlled by the various silencers and noise limiters described in past issues of QST.

— EDITOR.

The receiver described herewith is the result of this objective, after many weeks of extensive experimental work.

Now that regulations demand good frequency stability of 56-Mc. transmitters, the necessity for an extremely broad receiver no longer exists. This in turn eliminates the most outstanding point upon which the very existence of the 56-Mc. superregenerative receiver has been based all these years, and also removes the only argument which has in the past been against the use of a five-meter superheterodyne receiver.<sup>1</sup>

The receiver described herewith was found to be more sensitive than any superregenerative receiver with which it was compared. It is sufficiently broad to receive, perfectly, any form of stabilized modulated oscillator, and even properly-operated unstabilized oscillators, (now outlawed on 56 Mc.) while at the same time possessing the selectivity required for reducing interference from nearby stations operating near the frequency to which the receiver is tuned. As a matter of fact, in most cases no interference could be noticed from nearby high-power stations operating within 30 kc. of the frequency to which the receiver was tuned in the 56-Mc. band, while on a superregenerative receiver the same stations apparently took up half of the band. The selectivity, sensitivity, lack of background noise and improved audio quality provided by this receiver make 56-Mc. operation comparable with operation on the lower frequency bands.

### Tubes and Circuit

The r.f. stage provides plenty of gain. Both 954 acorn and 1851 tubes were tried. The 1851 was found to provide more gain, and at the same time it has the advantage of being less expensive. The r.f. stage tunes quite sharply, but not sufficiently so to necessitate the use of a tracking condenser to prevent loss of gain. Both inductive and capacitive methods of coupling the r.f. stage to the detector were tried. Using a 954 r.f. stage, the inductive method of coupling was preferred, but with the 1851 the gain is so great that oscillation of the r.f. stage could not be prevented while using this method of coupling. The capacitive method was therefore used by reason of necessity.

The 954 acorn was found to be far superior to other tubes for use as a mixer. This is not hard to understand when it is realized that acorn tubes are especially designed for ultra-high-frequency work. In order to reduce capacities to a minimum and therefore enable the use of as large an inductance as possible in the grid circuit of the detector for greater sensitivity, it was decided to prune the detector grid coil to resonance rather than to use a padding condenser across the coil. It might be well to state at this time that all coils are very critical and should be made exactly as specified. This is especially true of the detector coil, since it must be adjusted to exact resonance only by compressing or expanding the turns.

A 955 acorn was chosen as a high-frequency oscillator since its characteristics make it particularly adaptable to this application. The use of a very low  $LC$  ratio makes the oscillator extremely stable. The 955 will oscillate more freely with a low  $LC$  ratio than other tubes tried, and its internal capacity changes less with heating than other tubes, thereby minimizing frequency drift. The stability of the receiver is surprisingly good,

Unless better receivers are used, much of the benefit that should result from the stable transmitters now required on the 56-Mc. band cannot be realized. Here is a thoroughly practical 5-meter super; one which will effectively increase the width of the band by many times as compared to the superregenerative receiver. In congested areas, the 5-meter super is the new order of the day.

being better at 56 Mc. than many other receivers were found to be at 14 or 28 Mc.

### The I.F. Amplifier

A 1600-kc. intermediate frequency was chosen to provide the desired band width without sacrificing gain. A higher frequency would reduce gain and a lower frequency would not provide adequate band width or good image suppression. Using the 1600-kc. i.f. with a 6K7 pentode tube and iron core i.f. transformers, it was found that one i.f. stage was quite satisfactory. It was found necessary to use maximum i.f. gain only on extremely weak DX signals. The choice of proper transformers as specified is important, since the particular brand of i.f. transformers used is made in three types at 1600 kc.

A regenerative second detector was chosen for two reasons. First, it provides an economical means of permitting reception of c.w. signals on the receiver. It might be well to mention that plenty of c.w. 56-Mc. signals can be heard, too, although the user of a superregenerative receiver might be apt to think that c.w. signals do not exist on 56 Mc. Secondly, the regenerative feature provides increased sensitivity in the reception of 'phone signals and increased selectivity in the reception of c.w. signals. Sensitivity and selectivity increase as the regeneration control is ad-

This plan view of W3GS' 56-Mc. super shows how the r.f. section, at right, is separated from the i.f. amplifier, second detector and audio amplifier. The acorn mixer and oscillator tubes are mounted on aluminum partitions. The r.f. stage uses an 1851.

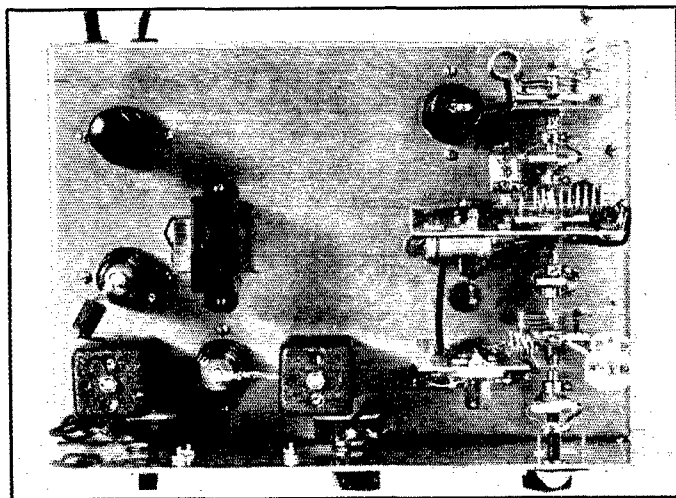

vanced toward the point of actual regeneration, the most sensitive point being right before regeneration begins. With the regeneration control "off" (extreme counter clockwise position) the second detector operates in the same fashion as in any conventional superhet receiver. A high-impedance choke instead of a resistor is used as the plate load of the second detector, to minimize voltage drop and variation of plate voltage with changes in regeneration control setting.

One 6F5 audio stage provides sufficient loud-speaker volume for all practical purposes. The original model of the receiver has no audio gain control, volume being controlled entirely by means of the i.f. gain control. However, a 500,000-ohm potentiometer can readily be substituted in the grid circuit of the 6F6 for use as an audio volume control if desired.

Since fading on 56 Mc. seems to be a minor consideration as compared to other bands, and since even the strongest signals did not block the first detector, the extra expense and complications of adding a system of a.v.c. were considered unnecessary at this time. When fading does occur on 56 Mc. it seems to be very slow and gradual and can easily be followed by manipulation of i.f. gain control.

The entire receiver is constructed on a chassis measuring 8½ inches deep by 12 inches long by 2

inches high. This size was chosen to allow sufficient depth for ganging r.f., detector and oscillator condensers without cramping the components. Adequate separation is provided between these stages to eliminate any possibility of undesirable coupling or interaction. The chassis was chosen of such length as to permit the i.f., second detector and audio stages all to be sufficiently isolated from the high-frequency circuits.

### Notes on Construction

The most important details of construction pertain to the assembly and wiring of the high-frequency stages. Parts are arranged to permit extremely short r.f. leads and direct by-passing of all r.f. circuits. This is accomplished by mounting the acorn sockets on vertical aluminum partitions. A general idea of this construction can be had from the photograph. At the front of the chassis, at the right-hand end, are the oscillator stage and its component parts. The 955 tube is mounted on a vertical partition 2¾ inches high by 2¼ inches wide. The socket is arranged with the cathode terminal facing towards the upper right corner of the partition, making a short and direct lead for the tap on the coil, and placing the grid terminal in a position which will allow a short and direct connection to the grid end of the oscillator coil through the 100-μμfd. grid condenser.

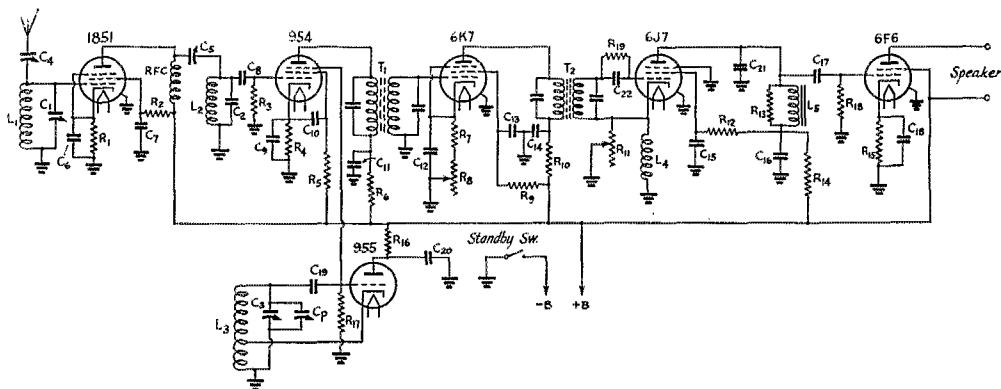

Fig. 1 — 56-Mc. superhet circuit diagram.

- C<sub>1</sub>, C<sub>2</sub> — 10-μμfd. (Cardwell ZR-10-AS).
- C<sub>3</sub> — 15-μμfd. (Cardwell ZR-15-AS).
- C<sub>4</sub>, C<sub>5</sub> — 3-35-μμfd. (Isolantite) padders.
- C<sub>p</sub> — 50-μμfd. air padder (Hammarlund APC-50).
- C<sub>6</sub>, C<sub>7</sub>, C<sub>9</sub>, C<sub>10</sub> — 0.01-μfd., 400-volt tubular.
- C<sub>8</sub>, C<sub>19</sub>, C<sub>22</sub> — 100-μμfd. midget mica.
- C<sub>11</sub>, C<sub>14</sub> — 0.05-μfd., 400-volt tubular.
- C<sub>12</sub>, C<sub>13</sub>, C<sub>15</sub>, C<sub>16</sub> — 0.1-μfd., 400-volt tubular.
- C<sub>17</sub> — 0.02-μfd., 400-volt tubular.
- C<sub>18</sub> — 10-μfd., 25-volt tubular.
- C<sub>20</sub> — 0.001-μfd. midget mica.

- C<sub>21</sub> — 0.002-μfd., 400-volt tubular.
- R<sub>1</sub> — 150 ohms, ½-watt.
- R<sub>2</sub> — 60,000 ohms, ½-watt.
- R<sub>3</sub> — 1 meg., ½-watt.
- R<sub>4</sub>, R<sub>10</sub> — 2000 ohms, ½-watt.
- R<sub>5</sub>, R<sub>12</sub>, R<sub>16</sub> — 100,000 ohms, ½-watt.
- R<sub>6</sub> — 2000 ohms, ½-watt.
- R<sub>7</sub> — 300 ohms, ½-watt.
- R<sub>8</sub> — 50,000-ohm potentiometer.
- R<sub>9</sub>, R<sub>17</sub> — 50,000 ohms, ½-watt.
- R<sub>11</sub> — 1000-ohm potentiometer.
- R<sub>13</sub> — 250,000 ohms, ½-watt.
- R<sub>14</sub> — 25,000 ohms, ½-watt.
- R<sub>15</sub> — 450 ohms, 10-watt.
- R<sub>18</sub> — 500,000 ohms, ½-watt.
- R<sub>19</sub> — 5 meg., ½-watt.

- L<sub>1</sub> — 8 turns No. 14, ½" diameter, winding length 1½".
- L<sub>2</sub> — 9 turns No. 14, ½" diameter, winding length 1½".
- L<sub>3</sub> — 4 turns No. 14, ½" diameter, winding length ½" (cathode tap ½ turn from ground turns).
- L<sub>4</sub> — 30 turns No. 24, close-wound on ½" form.
- L<sub>5</sub> — 1080-henry plate impedance (Thoradson T-29C27).
- RFC — 2½-mh. r.f. choke (National R100).
- T<sub>1</sub> — 1600-kc. iron core i.f. (Meissner No. 16-8091).
- T<sub>2</sub> — 1600-kc. iron core i.f. (Meissner No. 16-8099).



The midget air oscillator padding condenser and oscillator coil are mounted directly on the oscillator tuning condenser.

Directly behind the oscillator stage is the first detector. This complete assembly is made up on a 4-inch wide by 2¾-inch high aluminum partition. The 954 acorn tube is mounted to the left of the tuning condenser with its plate terminal protruding through a ¾-inch hole for short direct connection to the coupling condenser from the plate of the r.f. stage. This aluminum partition, in addition to offering support for all the component parts of the detector stage, also provides adequate shielding between stages. In the case of the r.f. stage, only the tuning condenser is mounted on the aluminum upright. This upright is 2¾ inches high by 2¼ inches wide, and likewise shields the r.f. coil and tuning condenser from the detector stage. The 1851 tube is mounted directly to the left of this assembly, making a short grid lead to the coil and at the same time assuming a position which allows a short lead to the coupling condenser, which is fastened directly to the stator terminal of the detector tuning condenser.

Initial adjustments, after construction is completed, are made as follows: The i.f. transformers are padded and adjusted to 1600 kc. Then with tuning condensers set at half capacity, the oscillator padding condenser is adjusted until a signal of approximately 58 Mc. is heard. A test oscillator is helpful, although a signal from the transmitter can be used, or perhaps some local 58-Mc. signal can be heard. If coils are made in accordance with specifications, the oscillator padding condenser will fall at a point slightly less than half meshed. The r.f. coupling condenser is then adjusted and the r.f. and detector coils pruned for maximum signal strength. As previously mentioned, the coils are pruned by compressing or expanding turns slightly, and when adjusted for the middle of the band will track sufficiently well over the entire band. The antenna trimmer condenser is also adjusted for best sensitivity with the particular antenna with which the set is used.

The background noise in the set will be found to be extremely low, and the actual operation very similar to any of the familiar superhet receivers in use on lower-frequency bands, with the exception of the regeneration control. The sensitivity will be surprisingly good and the operation very smooth. Any well-filtered power supply delivering approximately 250 volts at 70 ma. will be satisfactory.

## Straits

Early in December W9TGG received on the same day QSL cards from W5HAT and W6HAT! The following week, W4EFK received cards on the same day from W8OHA and W9OHA! Sounds like an epidemic, doesn't it?

## Philip C. Murray, W9VYU

**P**HIL MURRAY, W9VYU, met death by electrocution last December 7th.

His tragic end must give every amateur pause, for it resulted from circumstances which might occur at any time in any amateur station in the absence of suitable safety precautions.

It was no high-powered transmitter that caused Phil Murray's death; no 3000-volt power supply sent a powerful electric current coursing through his body. It was an ordinary speech amplifier that provided the fatal energy — a potential probably not exceeding 500 volts. That such a commonplace piece of gear could deal death seems incredible.

Yet Phil Murray is dead.

For the details of his death *QST* is indebted to W9DOQ and the Arrowhead Radio Club. The circumstances have been established through investigations by W. C. Lounsbury, director of safety, and by the engineering department of the Cloquet Division of the Minnesota Power and Light Co., by whom W9VYU was employed.

At 8:30 of the evening of December 7th, Murray and Francis Johnson, a close friend of his and also an amateur, were attempting to isolate noise that had developed in Johnson's speech amplifier. Murray picked up the crystal microphone, the case of which was connected to the chassis of the amplifier through the customary woven shielding on the microphone cable. As he did so he received a jolt and dropped the microphone. It hit the table and started to fall over, whereupon, to save it, Murray stepped forward and grasped the

(Continued on page 98)

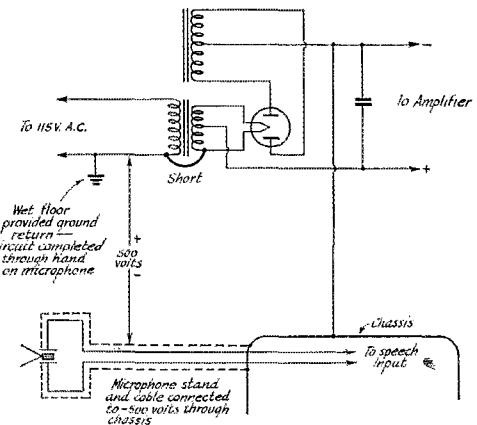

The fatal short circuit — had the chassis been grounded, the lethal potential could not have existed and probably the only damage would have been a blown line fuse

# Eight Years Before the Mike

**W9UA-W9BSP—A.R.R.L.'s Leading Code-Practice Volunteer**

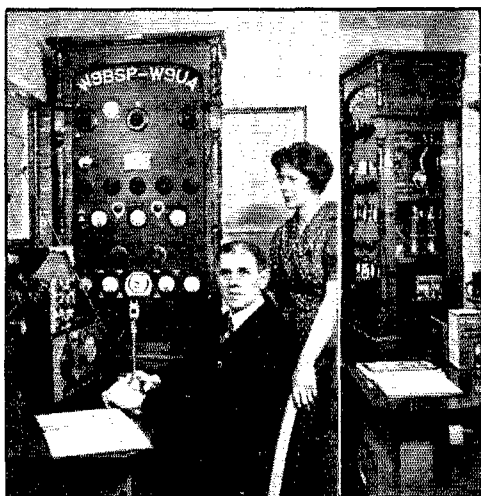

Marshall H. Ensor (W9BSP) and Loretta Ensor (W9UA) at the operating position. Right, latest transmitter at W9BSP.

**W**9BSP will, no doubt, be remembered by many amateurs as long as they live, for it is from this station that hundreds of amateurs have received the thrill of copying their first bit of international code.

The station, owned and operated by Marshall H. Ensor and his sister Loretta Ensor (W9UA), has served as an A.R.R.L. Volunteer Code Practice Station every year, with the exception of one or two since 1930. During the last season, cards were received from 550 individuals who were following the course. Many others who did not report by card or letter are believed to have been copying the fifty lessons which constituted the course. Mr. Ensor is an instructor in the Industrial Arts Department of Olathe High School.

The station dates back to 1917 when a brief period of operation with a spark transmitter was interrupted by the War. It was not until 1922 that activities were resumed, this time with a self-excited c.w. transmitter using 202's powered by a 1½-h.p. gasoline-engine-driven generator. The following year CB8 in Argentina was worked for the first Argentine-W9 contact. During 1925 and 1926 both 160-meter 'phone and 40-meter c.w. were used regularly. By this time a pair of 203-A's and a 4-h.p. engine had been acquired. Forty-meter operation was dropped in 1929 and a new 250-watt 'phone rig was built with a 1200-volt

storage battery furnishing plate supply. Many fine contacts were made during the year.

In 1930 volunteer code practice work was started. W9BSP was one of the first to volunteer for this work and has since been one of the foremost in the field.

The latest transmitter, shown in the photographs, has been in service since October. It was designed for 80- and 160-meter 'phone operation. The hard-board panels and shelves are supported by a steel frame. Over this is placed a quickly-removable three-section walnut cabinet to protect the equipment from dust and to give a finished appearance. Each unit of the transmitter is placed on a shelf by itself and the r.f. stages are all link-coupled. The upper shelf supports the 1-kw. Class-C amplifier, incorporating a pair of T814's in push-pull link-coupled to the antenna pick-up coil. On the next lower shelf is the 6L6 oscillator, T756 amplifier and 845 driver. The T822 modulators may be seen on the second shelf. Behind these are a Thordarson speech-amplifier unit, filament-heating transformers and the howler used for code practice transmissions.

The lower shelf supports two power supplies. One 600-volt unit supplies the oscillator and first r.f. amplifier while the other is used for C bias on the r.f. stages. The power supply for the driver, modulator and final r.f. stages is located in the basement. It consists of two 1½-kw. pole transformers and a pair of 872 rectifiers. Each section of the filter has a 3-kw. pole transformer primary for swinging choke. All transformers run in oil and show no rise in temperature after long periods of operation. The filter condenser for the modulator has a capacity of 9 µfd., while 13 µfd. are used in the section supplying the r.f. stages. This power supply delivers 1600 volts at 600 ma. for the final amplifier.

Several features of this station may be of interest. A 30-inch neon rod throws a glow which is visible for a quarter-mile when modulation takes place. A Dupont oscilloscope is link-coupled to the transmitter and shows either trapezoidal or envelope pattern of the signal on all transmissions. Three voltmeters are used in conjunction with switches to indicate filament, plate and grid voltages. Three milliammeters are used with plugs to check currents. A resistance unit imbedded in a concrete block is connected in series with the filament supply to keep the filaments at one-half operating voltage during stand-by periods. It is located under the operating table and serves admirably as a foot-warmer in cold

*(Continued on page 94)*

# What's Your Crystal Frequency?

★  
BY DON L. LUSK,\* W3ZF

★

## *Discussing the Factors Which Can—and Do—Make the Actual Frequency Different from That on the Label*

**D**URING recent DX contests it has been the writer's duty, as an Official Observer, to check the frequencies of amateur stations operating outside or very near the edges of our bands. A surprisingly large number of stations were operating outside the international assignments. It was hard to believe that so much off-frequency operation could be deliberate; consequently an investigation was started to determine the cause. In the case of W stations measured off frequency, they were asked for an explanation. Here is a sample of the replies received: "I can't see how it is possible that I was off; why, I just had my frequency checked by so and so"; or, "I check my frequency regularly using a broadcast station for a standard, so I couldn't be off without knowing it"; "Maybe something might be wrong with your measuring instrument." Analysis of the reports received indicates beyond all reasonable doubt that a majority of these operators do not fully understand what to expect of crystal-controlled oscillators. It is the purpose of this article to point out in ham language just what happens to crystals under various conditions.

Considerable data are available<sup>1</sup> about crystals relative to temperature coefficients, variable load impedances, stray capacities, crystal holders, plate voltages or other factors, but how many operators consider these variables when they purchase crystals? It is an actual fact that they expect the crystal frequency to be exactly as marked *under any and all conditions!* They assume that a crystal never changes frequency—or, if it does, that the change is so small as to be negligible.<sup>2</sup> When such a man is finally convinced that his crystal is off frequency, he immediately blames the manufacturer, although about 99 per cent of the time it may be the operator's own fault.

### *Temperature Effects*

One major trouble is the frequency change caused by temperature. For example, an average X-cut crystal (average crystal, not all of them) has a temperature coefficient of minus 23 cycles per million cycles per degree centigrade. Let us

\* 116 W. Abbotsford Ave., Philadelphia, Pa.

<sup>1</sup> *The Radio Amateur's Handbook.*

<sup>2</sup> Allowance also should be made for calibration accuracy, the tolerances usually being specified by the manufacturer.  
— EDITOR.

elaborate on this point a little: It simply means that the crystal can be expected to change its fundamental frequency from the calibrated frequency by subtracting 23 cycles for each degree centigrade of temperature rise for each million cycles. A 3.5-megacycle crystal would therefore change 3.5 times 23 or 80.5 cycles for each degree temperature rise.

Right here is where we want to stop and think a bit. Probably you will say, "In my shack or room the temperature seldom varies much from 70 degrees Fahrenheit or 21.1 degrees centigrade, so why should I worry about temperature?" The answer is that the crystal probably is being used as a power oscillator with 300 or 400 volts on the oscillator tube plate, and with some 5 to 50 watts plate input. Certainly all of the power going into the oscillator does not appear in the output circuit, therefore the crystal must be dissipating a portion of this power, and where power is dissipated heating occurs. To prove this point, turn a crystal oscillator on (with a power level of this order) and let it run for a time. Then feel the crystal holder, or measure the temperature rise. The temperature often will rise to well over 100 degrees Fahrenheit even though the room temperature is only 70 degrees. What does this mean? What if it does rise that much? Well, if the temperature of a 3500-kc. X-cut crystal increases 20 degrees centigrade, then the crystal frequency will be outside the band by 1610 cycles! You might say, "But my crystal never gets that hot." It is suggested that you measure it yourself under actual operating conditions. We believe that you will then agree that a 20 degree change can and does happen frequently—too frequently.

We have no justification in taking a chance near the edges of a band with a crystal having

It shouldn't be necessary to explain what this is all about—not to anyone who has read the Editorial in January *QST*. If you haven't read it, dig out last month's *QST* and get yourself in the right frame of mind for appreciating this article. Remember, there's a DX Contest coming next month—those who slide over the edge may have a lot of fun, but they won't get any of the glory!

1610 cycles, more or less, frequency drift. If you insist on using this particular kind of crystal, then we recommend staying several kilocycles inside the band to allow a reasonable safety factor.

But you may say, "I like to operate near the edges. What kind of crystal could I depend upon?" Certainly not an X or Y cut. You could approach somewhat nearer with a *good* low-drift type such as the A, B, or V cuts, but even here one must be absolutely sure of his drift. A crystal operated very near the edges (but not nearer to the edge than 700 cycles) should have a temperature coefficient not exceeding 2 cycles per megacycle per degree centigrade for the 20-degree temperature rise estimated previously, assuming that the output frequency was 14 Mc. For 28-Mc. operation, using the same crystal and temperature range, it should be at least 1400 cycles inside the band. Table I is a tabulation of frequency versus temperature for crystals having different temperature coefficients. These figures represent drifts caused by temperature only. It is suggested that the table be consulted to find how many

cycles your particular crystal will vary, to determine how close you can approach to the edge with safety—after also taking into account factors to be discussed later.

Thus far we have talked principally about X-cut 3500-kc. crystals, and assumed operation on 80 meters. Suppose we take this same crystal and by means of doublers go on down to 40, 20, 10 and 5 meters and see what happens to our output frequency there. Our 1610 cycles drift on 3.5 Mc. becomes 3220 cycles on 7 Mc.; on 14 Mc. the error is 6440 cycles; on 28 Mc. it is 12,880 cycles off; and on 56 Mc. it is 25,760 cycles off. Whew—that is a lot of cycles to be off! You could come back with, "But I am not using an 80-meter crystal. I use a 40- or 20-meter plate." You still must multiply the temperature coefficient (23 cycles for X cuts only) by 7 or 14, which is equal to 161 and 322 cycles per degree C, respectively.

There is another side to this frequency drift picture—the receiving end. Have you ever had a very weak DX station drift from a clear channel into plenty of QRM and lose him? Have you

**TABLE I**  
**Frequency Drift in Cycles from Original Calibration for Crystals Having Different Temperature Coefficients**  
**For a 10-Degree Centigrade Temperature Rise**

Frequency in Mc.	Temperature coefficient 2 cycles *	Temperature coefficient 4 cycles *	Temperature coefficient 10 cycles *	Temperature coefficient 23 cycles *	Temperature coefficient 50 cycles *
1.700	34	68	170	391	850
2.000	40	80	200	460	1000
3.500	70	140	350	805	1750
4.000	80	160	400	920	2000
7.000	140	280	700	1610	3500
7.300	146	292	730	1679	3650
14.000	280	560	1400	3220	7000
14.400	288	576	1440	3312	7200
28.000	560	1120	2800	6440	14,000
30.000	600	1200	3000	6900	15,000
56.000	1120	2240	5600	12,880	28,000
60.000	1200	2400	6000	13,800	30,000

\* Cycles per megacycle per degree centigrade.

**For a 15-Degree Centigrade Temperature Rise**

Frequency in Mc.	Temperature coefficient 2 cycles *	Temperature coefficient 4 cycles *	Temperature coefficient 10 cycles *	Temperature coefficient 23 cycles *	Temperature coefficient 50 cycles *
1.700	51	102	255	586.5	1275
2.000	60	120	300	690	1500
3.500	105	210	525	1207.5	2825
4.000	120	240	600	1380	3000
7.000	210	420	1050	2415	5250
7.300	219	438	1095	2518.5	5475
14.000	420	840	2100	4830	10,500
14.400	432	864	2160	4968	10,800
28.000	840	1680	4200	9660	21,000
30.000	900	1800	4500	10,350	22,500
56.000	1800	3600	8400	19,320	42,000
60.000	1800	3600	9000	20,700	45,000

\* Cycles per megacycle per degree centigrade.

ever tried to read a signal with your crystal filter at maximum selectivity and have the signal drift so much that it was necessary to retune continually? It is difficult for the receiving operator to pull through such a signal, and in a good many cases they don't even bother. It is a great asset to have a perfectly stable note, one that does not creep all over the dial, one that is much easier to copy at the other end.

"I cannot afford a better crystal than the X or Y cuts; what am I to do?" If you cannot afford a good stable crystal then you have absolutely no right to operate near the edge of a band. The difference in cost between an X or Y and an A, B, or V cut is very small and it pays dividends. It may be interesting to know that a zero temperature-coefficient crystal requires extreme care in cutting and grinding, and an X-ray spectrometer must be used if the coefficient is to be much less than four cycles. Not many hand-made or home-made crystals have this stability.

### Other Causes of Frequency Shift

Another cause for frequency variation is changing load impedance. By doing nothing more than tuning the oscillator tank condenser, you can shift

the frequency from a few cycles to several kilocycles.<sup>3</sup> We suggest that you listen to your monitor to check this, particularly in the 10- and 20-meter bands. If you happen to be using a Tri-tet circuit, the cathode tank has an appreciable effect, and its tuning can be expected to change the frequency by as much as two kilocycles at 14 megacycles.<sup>4</sup>

Stray circuit capacities, while reasonably constant in their values, cause deviations in frequency from that marked on the crystal by the manufacturer. Manufacturers usually give circuit conditions and specifications with a crystal in an attempt to reduce the error. However, it is impossible to predict what the stray capacitance is under all conditions. An attempt is made to test a crystal under "average" conditions using circuits most common to amateur practice, but because of

(Continued on page 116)

<sup>3</sup> The effect is greater with triode oscillators than with tetrodes or pentodes, because the input capacity varies over a wider range with changes in load impedance. It is also increased with the latter types when a feedback capacity is added between grid and plate. — EDRON.

<sup>4</sup> This is particularly true when the cathode tank is tuned near the crystal frequency. When operated at a considerably higher frequency (the recommended condition) the frequency change with tuning is small. — EDRON.

### For a 20-Degree Centigrade Temperature Rise

Frequency in Mc.	Temperature coefficient 2 cycles *	Temperature coefficient 4 cycles *	Temperature coefficient 10 cycles *	Temperature coefficient 25 cycles *	Temperature coefficient 50 cycles *
1.700	68	136	340	782	1700
2.000	80	160	400	920	2000
3.500	140	280	700	1610	3500
4.000	160	320	800	1840	4000
7.000	280	560	1400	3220	7000
7.300	292	584	1460	3358	7300
14.000	560	1120	2800	6440	14,000
14.400	576	1152	2880	6624	14,400
28.000	1120	2240	5600	12,880	28,000
30.000	1200	2400	6000	13,800	30,000
56.000	2240	4480	11,200	25,760	56,000
60.000	2400	4800	12,000	27,600	60,000

\* Cycles per megacycle per degree centigrade.

### For a 25-Degree Centigrade Temperature Rise

Frequency in Mc.	Temperature coefficient 2 cycles *	Temperature coefficient 4 cycles *	Temperature coefficient 10 cycles *	Temperature coefficient 25 cycles *	Temperature coefficient 50 cycles *
1.700	85	170	425	977.5	2125
2.000	100	200	500	1150	2500
3.500	175	350	875	2012.5	4375
4.000	200	400	1000	2300	5000
7.000	350	700	1750	4025	8750
7.300	365	730	1825	4197.5	9125
14.000	700	1400	3500	8050	17,500
14.400	720	1440	3600	8280	18,000
28.000	1400	2800	7000	16,100	35,000
30.000	1500	3000	7500	17,250	37,500
56.000	2800	5600	14,000	32,200	70,000
60.000	3000	6000	15,000	34,500	75,000

\* Cycles per megacycle per degree centigrade.

The deviation may be either plus or minus except in the case of the X cut, which is always minus.

# Break-in Telephony With Carrier Suppression

*An Electronic System for Automatic Control of Transmitter and Receiver*

BY S. KAPLAN,\* PA0CM

THE progressive increase in the number of amateur transmitting stations has resulted in heavy overcrowding of the comparatively narrow frequency bands reserved for these stations. Since there is a natural limit to the selectivity of receivers, even the most up-to-date superheterodyne receivers with quartz filters afford only a partial alleviation of the difficulties accruing, and under favorable conditions of reception the bands frequently have to carry such a heavy load that satisfactory communication becomes quite impossible. Some form of international control is highly desirable to bring order out of this chaos, either by subdividing the frequency bands available according to their suitability for specific traffic, or by reserving special bands for radio telephone traffic, etc. But as no move for an international control on these lines has materialized, other means must be found to arrive at a solution of this vexing problem. A very coarse and simple method for improving the audibility of a transmitter is to increase its power output and simply swamp out any other transmitters operating on an adjoining wavelength, but this would afford no permanent solution, for, in the first place, it would result in a race for power output, and, secondly, a limit is set by the restric-

tion in plate input which has been imposed on amateur transmitting stations in the majority of countries.

Assume, for the moment, that of the large number of amateur transmitters each pair in communication is operating on the same frequency; this would have the net result that each frequency would be fully utilized, the demand on the frequency band in question would in consequence be considerably reduced and the safety factor for each specific link would be made much greater. The A.R.R.L. has recently endeavored to popularize this method of working by issuing a number of specifications for excitors which permit a rapid frequency change. This idea can, however, be further developed if two transmitters communicating with each other engage in break-in traffic, which apart from convenience naturally also affords an enormous saving in time and hence a still greater reduction of the load on the frequency band under discussion.

## Break-in Requirements

The problem of break-in traffic on the same frequency imposes the following requirements:

1. For telegraphic transmission the transmitter must be keyed in such a way that during the receiving period the transmitter is inaudible; i.e., keying must take place in the initial stages

\* Natuurkundig Laboratorium of N. V. Philips' Gloeilampenfabrieken, Eindhoven, Holland.

Fig. 1—Essentials of the transmitting control circuit.  $V_4$  is a doubler or buffer stage in the transmitter line-up; circuit values here are conventional. In the control circuit proper,  $T_1$  is a modulation transformer with a third winding giving an audio voltage of the order of 100 volts at negligible power.

Representative values in the control circuit are as follows)  $C_1$ , 0.001  $\mu$ fd.;  $C_2$ , 0.1  $\mu$ fd.;  $C_3$  1  $\mu$ fd.;  $C_4$ , 1  $\mu$ fd.;  $R_1$ , 250,000-ohm potentiometer;  $R_2$ , 0.5 megohm;  $R_3$ , 1 megohm;  $R_4$ , 100,000 ohms;  $R_5$ , 20,000 ohms;  $R_6$ , 100,000 ohms;  $R_7$ , 300,000 ohms;  $R_8$ , 10,000-ohm potentiometer.  $V_1$  may be a 6F6,  $V_2$  a 6X5,  $V_3$  two 6L6's in parallel (with screens tied to plates for triode connection) to control a 6L6 at  $V_4$ . A small (receiving-tube type) Class-B driver transformer may be used at  $T_2$ .

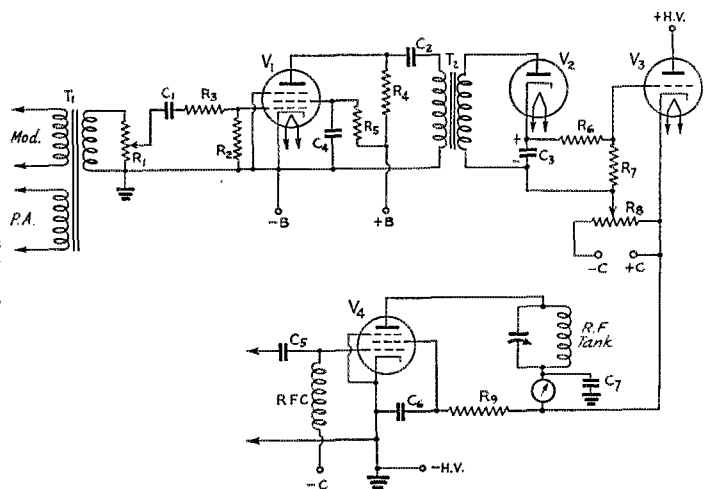

2. For telephone traffic, conditions are made more complex by the fact that the carrier wave must be suppressed during the receiving periods. This could be achieved, for instance, by modulating and switching the transmitter frequency-control stage, but all succeeding stages must then naturally be designed on Class-B principles. The efficiency would then suffer a serious reduction, and it becomes essential to retain Class-C amplification.

3. During the transmitting periods, the home receiver must be automatically made idle.

As the second requirement enumerated above is the more complex it will be discussed first, and the other two requirements dealt with subsequently.

Assume that carrier suppression is to be applied to a three-stage transmitter. This transmitter consists of a control stage, a frequency doubler and a power amplifier, the last two stages being designed as Class-C amplifiers with modulation taking place in the last stage. Two desiderata must be satisfied for break-in traffic on the same frequency, viz.: (1) During the receiving period the transmitter control must be inaudible. This can be realised either by detuning, or by reducing the power rating of the control stage to such a level and providing such adequate shielding that the signal remains permanently inaudible. After a long series of investigations we are convinced that it is much more convenient to employ the second method, since detuning the control transmitter reduces the frequency constancy and in addition supplementary apparatus, which adds to the total cost, is necessary to effect automatic detuning. If the transmitting frequency is the fourth harmonic of the control frequency, and if the control stage is made as small as possible and together with its plate-voltage rectifier is satisfactorily screened, it will remain inaudible even on a superhet receiver with a sensitivity of 0.5 microvolt placed at a distance of only one meter from the control transmitter.

The second condition, that the amplitude of the carrier wave shall be zero during the no-

Break-in 'phone operation should help relieve congestion in 'phone bands and make for more satisfactory conversations, by reducing the necessity for repeats and by enabling the receiving operator to come back immediately with a reply to a question. Imagine not having to wait ten minutes, taking notes all the while, for the fellow who has the air to get everything he can think of off his chest! Here is a system which not only puts the transmitter on the air when you start talking, but also silences the receiver at the same time. A short pause shuts down the transmitter and the receiver simultaneously snaps into action. It works on low-power stages, and no relays are needed.

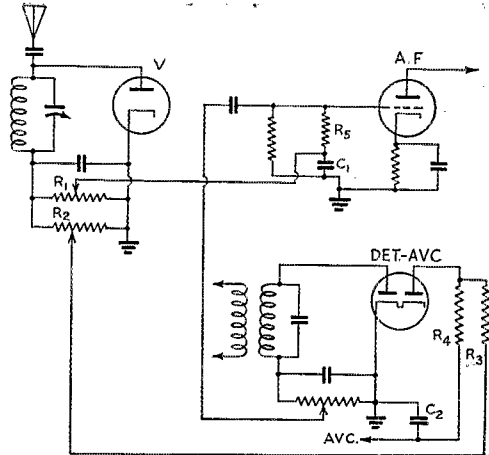

Fig. 2 — By means of this circuit, a small part of the r.f. output of the transmitter is rectified and applied as grid bias to receiver grids to silence the receiver when the transmitting carrier is on.  $R_1$  and  $R_2$  (1-megohm potentiometers) afford adjustment of the biasing voltage; the coupling between the tuned pickup tank in the rectifier circuit and the transmitter tank circuit proper should be adjusted so that about 40 volts is developed across  $R_1$  and  $R_2$ .  $R_5$  and  $C_1$  should have a small time constant; 5 megohms and 100  $\mu$ fd. are suggested values. The r.f. and i.f. tubes also can be biased to cut-off by applying the rectified voltage to the a.v.c. line of the receiver through  $R_3$ . Tube V is a 6H6; the other tubes are the diode rectifier and audio voltage amplifier of the conventional super.

speaking period, can also be satisfied in two different ways. The first method consists of continuous regulation of the amplitude of the carrier wave, i.e. as the depth of modulation increases the carrier amplitude also becomes greater, so that the depth of modulation always remains constant. This system of carrier control has the serious disadvantage that since the power output of the transmitter is continuously varying, reception with a.v.c. is rendered impossible. Moreover, with a small carrier-wave amplitude the receiver will be much more noisy than with a large amplitude, and reception will be unsteady. The second method consists in superposing the carrier when a specified speech amplitude is exceeded and suppressing it below this amplitude; this is in fact the method of carrier suppression in which the carrier amplitude remains constant and the depth of modulation is altered in the usual way. Reception with a.v.c. is then naturally directly possible and in the absence of a visual tuning device at the receiving station practically no difference will be observed between a transmitter with carrier-suppression and one without it.

The most primitive method of carrier suppression consists of providing a relay which operates when a specified speech amplitude is exceeded and which cuts in either the power amplifier or the frequency doubler stage. The

relay can, for instance, be inserted in the anode, the screen-grid or the control-grid circuit. The great disadvantage of this method is that the relay will always respond suddenly and superpose the carrier with a sharp impulse, an abrupt action which is extremely undesirable during reception. Nevertheless, this method is employed in small, inexpensive transmitters because of its very simplicity. The difficulty of realising steady reception thus lies in superposing the carrier rapidly but not impulsively and to suppress it suddenly yet with a finite delay. It should be possible to adjust the transmitter in such a way that it is cut out, for instance, between successive sentences but not during the intervals between words. This off-period must be capable of adjustment according to the speed of speaking. The use of tubes to eliminate all relays appears feasible for this purpose, since a tube can be cut in as quickly or as slowly as required, as compared with the closing time of a relay which is a mechanical constant.

### Transmitter Control Circuit

A circuit satisfying the requirements just set out is shown in Fig. 1. In addition to the secondary winding the output transformer of the modulator has a third supplementary winding. The modulating voltage obtained in this winding during speaking is passed through the potentiometer  $R_1$ , the condenser  $C_1$  and the resistance  $R_3$  to the grid of a pentode  $V_1$ . Resistance  $R_2$  serves as a grid leak. The screen-grid voltage is made very small, so that the grid bias likewise can be small. When a modulating voltage of a specific amplitude reaches the grid, grid current commences to flow. The grid current remains low with a small modulation voltage, but becomes so heavy when the voltage increases that a breakdown of the tube may even result; therefore resistance  $R_3$  is provided to limit the grid current. At the same time this resistance also restricts the plate-current amplitude. By keeping the screen voltage low and using resistance  $R_3$ , modulation amplitudes above a certain value are limited in both directions (upwards and downwards). If  $C_1$  is made too large it will acquire a large negative charge when grid rectification occurs, and this will adversely affect the action of the tube. For this reason the capacity of the condenser must be made very small, a measure which, however, cuts out to some extent the low frequencies, although this is unimportant in the present case as will be seen immediately below. A very high resistance is inserted in the plate circuit of the pentode, and this in turn acts as a powerful brake on the amplitude of the plate voltage in the upward direction (second limitation). The net result is that the alternating voltage at  $R_4$  is practically independent of the amplitude of the grid voltage, if the latter is so great that grid current commences to flow. We have thus realised an amplifier which in the grid-current

range furnishes an alternating voltage independent of the frequency and the grid amplitude. This alternating voltage is passed through condenser  $C_2$  to the primary winding of the transformer  $T_2$ . It is evident that if a sufficiently high modulation voltage is available, which is in fact always the case, the capacity of  $C_1$  can be very small. Experiments have shown that, for instance, from 10 volts alternating grid voltage up to 300 volts the alternating plate voltage remains absolutely constant. The lower limit of 10 volts can be displaced in either direction by means of suitable grid bias.

The constant alternating voltage obtained as described above is taken from the secondary side of transformer  $T_2$  and rectified by a diode  $V_2$  with low internal resistance. A constant direct voltage is then obtained at condenser  $C_3$ , so that on starting to speak into the microphone a constant direct voltage is immediately obtained at this condenser. To make the charging time of the condenser as short as possible, the diode must, as stated above, have a low internal resistance. Condenser  $C_3$  is bridged by resistances  $R_6$  and  $R_7$ . The discharge-time constant is thus determined by the product  $C_3 \times (R_6 + R_7)$ . If  $C_3$  is taken as  $1 \mu\text{fd.}$  and  $(R_6 + R_7)$  as 1 megohm, the time constant will be one second, i.e. one second after ceasing to speak  $C_3$  will be roughly half discharged, which is already sufficient to cut off the succeeding tube.

$V_3$  is a high- $\mu$  triode with low internal resistance. With the aid of  $R_3$  the grid bias is regulated in such a way that the plate current is just reduced to zero. If condenser  $C_3$  is charged, a positive impulse is applied to the grid of the triode  $V_3$ , this impulse persisting during speaking and being of such amplitude that the tube immediately operates in the grid-current range, and allows a heavy plate current to pass. Resistance  $R_6$ , which fulfills the same function as  $R_3$  with valve  $V_1$ , serves for limiting the grid current (third limitation). On ceasing to speak, condenser  $C_3$  is discharged through  $R_6 + R_7$  and the plate current in tube  $V_3$  again becomes zero. If  $V_3$  is located in the plate-voltage feed of a transmitting stage, this stage will as a result be connected and disconnected.

The delay in the cut-out can be controlled by suitable choice of  $C_3$ ,  $R_6$  and  $R_7$ . The switching-in point can be adjusted with the aid of the potentiometer,  $R_1$ , the delay being determined by the time constants of  $R_4$ ,  $T_2$  and  $V_2$  together with  $C_3$ . This delay is made very short, but not so short that charging is instantaneous. The delay in the cutting out is determined by the ratings chosen for  $R_6 + R_7$ .

Tube  $V_3$  switches the intermediate stage<sup>1</sup> of

<sup>1</sup> We see no urgent reason for confining the control to a buffer stage, which permits the oscillator to run continuously and necessitates exceptionally good shielding when the incoming signal is on the same frequency as the home transmitter. The average crystal oscillator will start readily enough, and if a self-excited oscillator is used for frequency



the transmitter in and out and hence does not have to be large, since the plate current of this stage usually is relatively small. A power triode can therefore be used for the switching tube. Since in all amplifying stages the plate current becomes zero on the absence of the excitation voltage (Class B or C), it is sufficient to control only one of the preliminary stages with the switching triode.<sup>2</sup>

By means of the arrangement described above, it is thus directly possible to obtain effective carrier suppression by using only three tubes. The same circuit can be used for telegraphy when  $R_5$  is not connected to  $C_3$  but through a key to a positive voltage.<sup>3</sup> A very smooth keying action entirely free from clicks is then obtained.

### Receiver Disabling

The third requirement indicated above, viz., the automatic cutting in and out of the receiver, can be satisfied quite simply. The circuit used for this purpose is shown in Fig. 2, where a diode rectifier tuned to the transmitting frequency is coupled to the output circuit of the transmitter. This coupling must be tight enough so that with the transmitter switched on the diode direct voltage measured at the potentiometers  $R_1$  and  $R_2$  is about 40 volts.

A high resistance  $R_5$  in series with a small condenser  $C_1$  (short time constant) is in parallel with the grid-leak resistance of either the first audio or the output tube of the receiver. The junction of  $R_5$  and  $C_1$  is connected to the sliding contact of the diode potentiometer  $R_1$ . When the transmitter is switched on, the slider of  $R_1$  is adjusted so that no signal is audible in the receiver. Since, when this occurs, the plate current of the tube is zero and the plate voltage of the oscillator or detector increases, which may result in a frequency shift, it is desirable to use the first audio tube for this purpose, because its plate current is low and in consequence reacts not at all or only slightly on the rectifier in the receiver. If the power output of the transmitter is relatively high, it is advisable to control the r.f. and i.f. stages as well, since under these conditions these tubes may be damaged by the very powerful signal sent out by the home transmitter. For this purpose, the direct voltage of the control diode is applied to the a. v. c. diode of the receiver.  $R_2$  is usually grounded,

control it should be possible, by using good design and keeping the input low, to maintain satisfactory stability for reliable communication even though there are periods of idleness. Control of a low-power stage likewise simplifies the constructional problems. — Editor.

<sup>2</sup> This assumes, of course, that fixed bias sufficient for plate-current cut-off is used on the succeeding stages. — Editor.

<sup>3</sup> Keying should be through a well-insulated relay, since the key is at the plate potential above ground. The same also applies to the heater circuits of  $V_2$  and  $V_3$ , as well as to the supply furnishing bias through  $R_8$  to  $V_3$ . The secondary winding of  $T_2$  should be insulated for the plate voltage on  $V_4$ .  $R_8$  should not be adjusted with the plate voltage on. — Editor.

but is here connected to the sliding contact of  $R_2$ . To obtain a low time constant the capacity of condenser  $C_2$ , which is usually of the order of 0.1  $\mu$ fd., must be reduced. The slider of  $R_2$  is so adjusted that with the transmitter switched on the r.f. and i.f. stages are cut out entirely. The receiver can without hesitation be connected to the transmitting aerial at a no-voltage point, e.g. to the center of the coupling coil.

The practical use of the system described is extremely simple and convenient. If a station is heard with which it is desired to communicate, the home transmitter can be tuned to its frequency by means of the monitor while the other station is calling. Once communication has been established, neither the transmitter nor the receiver need be further switched over. If the other transmitter is equipped for break-in traffic, communication is very rapidly set up automatically; should this not be the case the usual procedure is followed. If a general call is transmitted from the home station, other stations can at the same time be requested to change over to the same frequency or, to avoid interference from a series of distant stations, a similar request can be transmitted on receiving the first reply signals. For the sake of greater convenience a new Q abbreviation should be devised for the signal: "Change over to my frequency."

## Book Reviews

*The Radio Manual*, by George E. Sterling; D. Van Nostrand Company, Inc.; Third Edition, 1120 pages. \$6.00.

This is a new edition of a book which has a long record of popularity with those who wish to qualify for various types of commercial licenses or whose work lies in the fields of commercial, aviation and police radio. The author's background of long association with the Federal Communications Commission — he is Assistant Chief, Field Section, Engineering Department, of that body — enables him to write authoritatively on the many phases of radio applications.

In this Third Edition, approximately one-third of the text is devoted to electrical and radio principles, with the other two-thirds covering commercial radio equipment and its operation, international and domestic regulations, and license information. The "principles" section forms a rather good-sized text book in itself, covering in detail the operation of vacuum tubes and their application in oscillator and amplifier circuits. Sample calculations for predicting tube performance are worked out in almost every case, with the accent on practical engineering. The amateur who likes to dig under the surface a bit will find much meat in this part of the book.

It would be hopeless to attempt to describe in a few words the ground covered by the "operating" part of the book. Suffice to say that there are innumerable illustrations and descriptions of the latest commercial equipment, that such things as broadcast transmitters, police transmitters and receivers, marine direction finders, auto alarms, transport aircraft and ground station transmitters and receivers are discussed at length. F.C.C. regulations and the general

(Continued on page 92)

# Using Electromagnetic-Deflection Cathode-Ray Tubes in the Television Receiver

**Scanning, Synchronizing and Power Supply Circuits and Construction for Five- and Nine-Inch Kinescopes**

BY J. B. SHERMAN\*

**T**HIS article describes the construction of synchronizing, scanning, and power supply equipment for use with 5-inch and 9-inch Kinescopes of the electromagnetic-deflection type. The 9-inch outfit was shown in the photograph of the receiver in Mr. C. C. Shumard's December article,<sup>1</sup> and the 5-inch outfit is equally well suited for use with the same receiver. Another 5-inch Kinescope arrangement, with electrostatic deflection, will be described in a subsequent article.

## Scanning Circuit

Fig. 1 shows the circuit of a scanning unit suitable for use with either Type 1801 (5-inch) or 1800 (9-inch) Kinescope. A composite signal consisting of both vertical and horizontal synchronizing impulses of negative polarity is supplied from the receiver to the post marked "sync. input." The constants of the circuit associated with the first 6N7 are so chosen that the vertical impulse alone is delivered to the vertical oscillator and the horizontal impulse alone is delivered to the horizontal oscillator. A good discussion of the operation of the blocking oscillator, discharge tube, and output circuits used to generate saw-tooth deflecting currents in the deflecting yoke will be found in the bulletins on the RCA 1800 and 1801, and will, therefore, not be repeated here.

The apparatus of Fig. 1 is mounted on a chassis  $8 \times 17 \times 3$  inches, with a front panel  $8\frac{3}{4} \times 19$  inches, as shown in Figs. 2 and 3. This is suitable for rack mounting, or the unit may be mounted back of a wooden panel in a cabinet with the balance of the receiver. Of the various controls

\* Research and Engineering Dept., RCA Manufacturing Co., Harrison, N. J.

<sup>1</sup> C. C. Shumard, "A Practical Television Receiver for the Amateur," *QST*, December, 1938; also, by the same author, "Construction and Alignment of the Television Receiver," *QST*, January, 1939.

required, it is desirable to place on the front panel the two fine-speed (frequency), the two size, and the two centering adjustments, making six panel controls. The rest of the controls may be screw-driver adjustments located on the rear of the chassis. Fig. 4 shows the layout of parts on the scanning chassis. The deflection outputs are brought to a socket mounted at the rear, into which is plugged a 4-wire cable from the deflecting yoke in the Kinescope unit. Each of the two pairs in this cable should be twisted.

The horizontal centering control is a 50-ohm General Radio Type 214A potentiometer which has been center-tapped. The tap can be easily made to a single turn raised about  $\frac{1}{16}$  inch with a small screwdriver. The raised portion is cleaned and a light flexible lead attached with ordinary rosincore solder. A small square of cambric slipped under the raised turn will insulate and support the connection.

The peak voltages between the 6L6G plate and other socket connections are very high and the usual wafer socket will almost surely break down. A good ceramic socket should be used for the 6L6G tube.

The scanning power-supply requirements are moderate, and therefore this supply is conveniently incorporated into the scanning chassis. A separate transformer with 1500-volt insulation is used for the filament of the 1-V tube and is mounted on the underside of the chassis.

## Kinescope Power Supplies

The scanning unit described will provide ample deflecting currents for either the 5-inch or 9-inch Kinescope. The 5-inch tube is operated at 3000 volts second anode, the 9-inch tube at 6000 volts. The circuits of the power supplies for the two Kinescopes are shown respectively in Figs. 5 and 6. The Kinescope itself is housed separately and

In this article, picture-reproduction systems alternative to those described in October *QST* are presented from the practical circuit and construction standpoint. The circuits are for magnetic-deflection television-type tubes as contrasted with the oscilloscope-type tubes previously considered, and dovetail into the receiver circuit described in the December and January issues. The larger screen area (five- and nine-inch diameter as compared with three-inch and smaller oscilloscope tubes) naturally makes for better picture reproduction. In a subsequent issue, similar information on using the new electrostatic-deflection tubes will be given.

connected to its power supply by a cable enclosed in grounded copper braid, and to the scanning unit by the 4-wire cable mentioned previously. The high-voltage cable requires four wires for the 1801 and five for the 1800. The second-anode leads for both tubes, and first-anode lead for the 1800, should be automobile high-tension wire.

Figs. 7 and 8 show the external appearance of the 1801 and 1800 supplies respectively; and Figs. 9 and 10, the undersides of the chassis. The

chassis are  $8 \times 17 \times 3$  inches, with front panel  $8\frac{3}{4}$  by 19 inches. It will be noted that thorough precautions have been taken to safeguard the operator against the high voltages used. The primary leads of the power transformer run through two pairs of pin jacks which open the 110-volt circuit when the cover is removed from the underside of the chassis. Similar interlocks are located on the Kinescope housing. In addition, a gravity-operated relay with coil connected

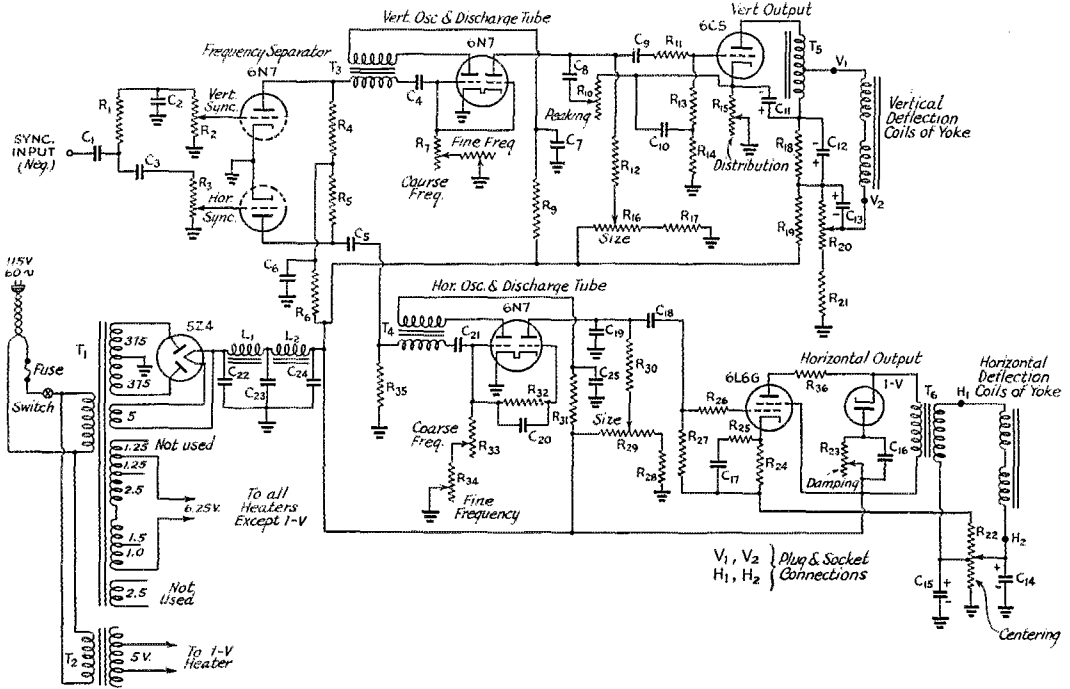

Fig. 1 — Synchronizing and scanning circuit for the 1801 and 1800.

- |   |  |  |  |
|---|--|--|--|
| $C_1, C_7, C_9, C_{16}$ — 0.25- $\mu$ fd., 400-volt paper.      | $C_{23}, C_{24}$ — 16- $\mu$ fd., 450-volt electrolytic.     | $R_{17}, R_{28}, R_{32}$ — 5000 ohms, $\frac{1}{2}$ -watt.                       | windings (RCA No. 9551).                                     |
| $C_2, C_{21}$ — 0.001- $\mu$ fd., 200-volt mica.                | $C_{25}$ — 0.05- $\mu$ fd., 400-volt paper.                  | $R_{19}$ — 5000 ohms, $\frac{1}{2}$ -watt.                                       | $T_2$ — 5-volt filament transformer (Jefferson No. 464-221). |
| $C_3$ — 25- $\mu$ fd., 200-volt mica.                           | $R_1, R_9, R_31$ — 0.1-megohm, $\frac{1}{2}$ -watt.          | $R_{21}$ — 50,000 ohms, 1-watt.  | $T_3$ — Vertical oscillation transformer (RCA No. 9834).     |
| $C_4, C_8$ — 0.1- $\mu$ fd., 400-volt paper.                    | $R_2, R_3, R_7$ — 0.2-megohm potentiometer.                  | $R_{22}$ — 50-ohm center-tapped potentiometer (GR 214A center-tapped).           | $T_4$ — Horizontal oscillation transformer (RCA No. 9835).   |
| $C_5$ — 0.005- $\mu$ fd., 400-volt mica.                        | $R_4, R_5, R_{18}$ — 3000 ohms, 1-watt.                      | $R_{23}$ — 15,000-ohm potentiometer.   | $T_5$ — Vertical output reactor (RCA No. 9833).              |
| $C_6, C_{22}$ — 4- $\mu$ fd., 450-volt electrolytic.            | $R_6$ — 4000 ohms, 2-watt.                                   | $R_{24}$ — 330 ohms, wire-wound.   | $T_6$ — Horizontal output transformer (RCA No. 9836).        |
| $C_{10}$ — 0.02- $\mu$ fd., 200-volt paper.                     | $R_8, R_{20}$ — 50,000-ohm potentiometer.                    | $R_{25}, R_{26}$ — 100 ohms, $\frac{1}{2}$ -watt.                                | $L_1, L_2$ — 20 henrys, 90 ma., 400 ohms (UTC).              |
| $C_{11}, C_{12}, C_{13}$ — 8- $\mu$ fd., 450-volt electrolytic. | $R_{10}, R_{16}, R_{29}, R_{33}$ — 0.1-megohm potentiometer. | $R_{27}$ — 10,000-ohm potentiometer.   | Yoke — Deflecting yoke (RCA No. 9831).                       |
| $C_{14}, C_{15}$ — 25- $\mu$ fd., 50-volt electrolytic.         | $R_{11}$ — 0.75-megohm, $\frac{1}{2}$ -watt.                 | $R_{35}$ — 500 ohms, $\frac{1}{2}$ -watt.  |  |
| $C_{17}$ — 5- $\mu$ fd., 50-volt electrolytic.                  | $R_{12}$ — 1-megohm, $\frac{1}{2}$ -watt.                    | $R_{36}$ — 100 ohms, 1-watt.   |  |
| $C_{18}$ — 0.002- $\mu$ fd., 400-volt mica.                     | $R_{13}, R_{27}, R_{30}$ — 0.5-megohm, $\frac{1}{2}$ -watt.  | $T_1$ — Power transformer, 375 volts each side c. t., with 6.3 and 5-volt heater |  |
| $C_{19}$ — 250- $\mu$ fd., 400-volt mica.                       | $R_{14}$ — 1.5-megohm, $\frac{1}{2}$ -watt.                  |  |  |
| $C_{20}$ — 800- $\mu$ fd., 200-volt mica.                       | $R_{15}$ — 5000-ohm potentiometer.                           |  |  |

Fig. 2 — Panel view of the scanning unit shown schematically in Fig. 1.

across the power-transformer primary shorts the high-voltage output when the 110-volt supply is disconnected. The chassis itself should be securely grounded. While these precautions may seem elaborate, the subject of high-voltage protection certainly deserves all the attention possible.

The only control located on the high-voltage supply is that of focus. The potentiometer for this job is mounted on a strip of bakelite set back from the front of the chassis, and an insulating coupling is inserted in the controlling shaft. The resistors for the high-voltage divider are mounted on the same bakelite strip. In the case of the 1801 supply, the 879 rectifier tube is also mounted on this strip. This horizontal mounting is permissible only if the tube is mounted with the filament pins in a vertical plane, that is, one above the other. In the case of the 1800 supply, horizontal mounting of the 878 is not permissible, and a convenient and safe arrangement is to support the rectifier inverted in a kind of

chimney, so that the plate connection is available beneath the chassis, from which side the tube is inserted. A National 4-pin socket mounted on the cover of the chimney by means of the standoff support supplied with this socket makes a very satisfactory arrangement. The filament leads are brought down alongside the tube. The chimney shown in Fig. 8 is a 3-inch aluminum tube with  $\frac{1}{2}$  6-inch wall, 6 inches long. Small holes are drilled in the cover and around the base for ventilation. The hole in the chassis is slightly less than the diameter of the aluminum tube.

The output voltages are brought to a bakelite terminal board equipped with General Radio pin jacks, the leads from the Kinescope being provided with pins for easy disconnection. The other end of the supply cable is connected permanently at the Kinescope housing.

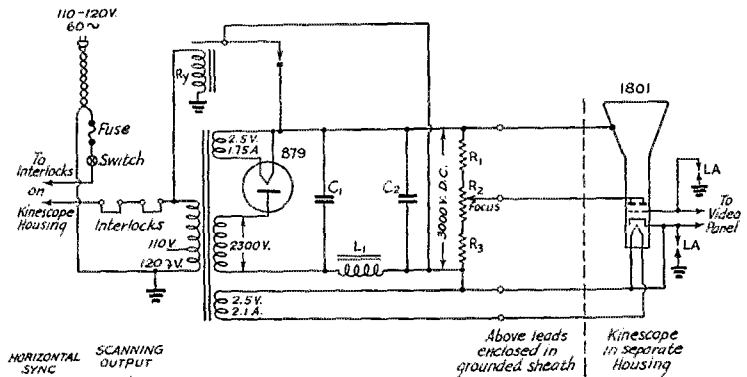

Fig. 5 — Power supply circuit for the 1801.

- C<sub>1</sub> — 0.025- $\mu$ fd., 4000-volt (Combined in one unit, RCA No. 9840).
- C<sub>2</sub> — 0.05- $\mu$ fd., 3500-volt (Combined in one unit, RCA No. 9840).
- R<sub>1</sub> — 3 megohms, 3-watt (3 1-meg., 1-watt units in series).
- R<sub>2</sub> — 0.5-megohm, 1-watt potentiometer.
- R<sub>3</sub> — 0.25-megohm, 1-watt.
- L<sub>1</sub> — 1500 henrys (RCA No. 9838).
- T<sub>1</sub> — Power transformer (RCA No. 9839).
- LA — Neon-type lightning arrester (Brach No. 27A).
- R<sub>y</sub> — High-voltage shorting relay, gravity operated.

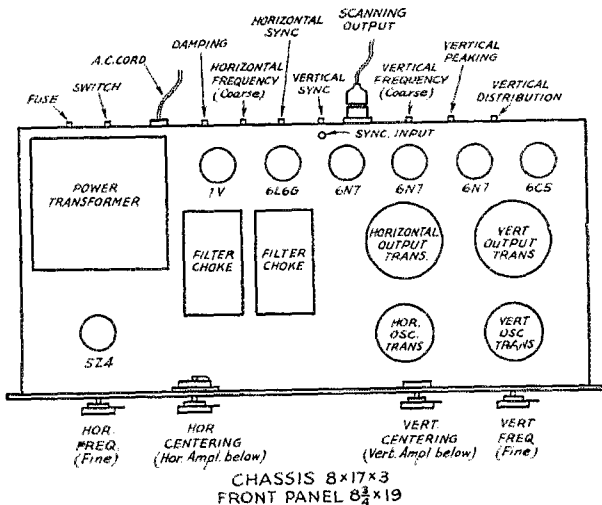
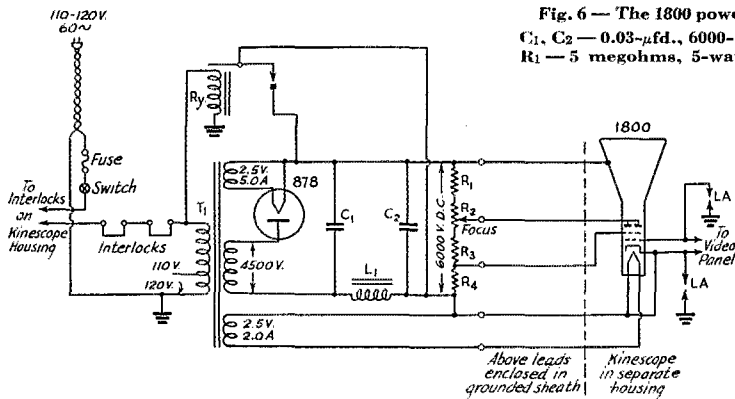

Fig. 4 — Chassis layout drawing for the scanning unit.



**Fig. 6 — The 1800 power supply circuit.**  
 C<sub>1</sub>, C<sub>2</sub> — 0.03- $\mu$ fd., 6000-volt.  
 R<sub>1</sub> — 5 megohms, 5-watt (5 1-meg., 1-watt units in series).  
 R<sub>2</sub> — 0.5-megohm, 1-watt potentiometer.  
 R<sub>3</sub> — 0.75-megohm, 1-watt.  
 R<sub>4</sub> — 0.3-megohm, 1-watt.  
 L<sub>1</sub> — 1500 henrys (RCA No. 9838).  
 T<sub>1</sub> — Power transformer.  
 LA — Neon-type lightning arrester (Brach No. 27A).  
 Ry — High-voltage shorting relay, gravity operated.

### Kinescope Housings

Fig. 11 shows the housings for the 5-inch and 9-inch tubes. Shelby seamless iron tubing, which is available from metal-products distributors in a large variety of sizes and weights, is used for the purpose of providing shielding of the Kinescope from stray static and magnetic fields as well as for safety reasons. The 1801 requires a piece of tubing 16½ inches long and 5½ inches inside diameter. A wall of 1/16 or 1/8 inch is suitable. For the 1800, tubing 15 inches long and 5½ inches inside diameter is used with a conical section cut from thin aluminum. The photograph shows a front fitted with safety glass; this provides mechanical protection to the tube and to the viewer.

It is important that the iron tubing used for shielding should not be magnetized, in order to avoid interference with both focus and deflection. Should demagnetizing be necessary, a suitable coil consists of about 500 turns of No. 18 enamel cotton-covered copper wire random-wound on a 7-inch cardboard form to make a coil about 1¼ inches long and 7/8 inch deep. This may be connected directly to the 110-volt, 60-cycle supply. In operation, while voltage is applied to the coil the iron tubing is passed through the coil and carried several feet to one side before the voltage is removed.

Instead of iron tubing, aluminum tubing can also be used for shielding. The magnetic shielding afforded will not be as effective, however.

The Kinescope socket is mounted in the center of a 1/16-inch iron disc 7½ inches in diameter, as shown in Fig. 12. A convenient arrangement which permits rotation of the socket is indi-

cated in Fig. 13. A National socket (5-pin for 1801 and 6-pin for 1800) is mounted on a bakelite strip in which has been drilled a single hole to clear the springs, and the mounting plate furnished with the socket is inverted and placed over the top of the socket. Spacers between the plate and the bakelite allow the socket to rotate freely. A bakelite plunger through the hole in the center of the socket rests on a snap switch mounted beneath the socket. This is a Hart and Hegeman switch which snaps closed when pressed. It is connected in series with the high-voltage transformer primary, and thus acts to disconnect the high voltage when the Kinescope is removed from its socket. The reason for this is evident: The second anode lead, carrying the highest voltage, can easily be reached from the front of the tube housing if the Kinescope is removed; this is probably the most accessible high-voltage point in most television receiving equipment and therefore merits particular precaution. The tube housing is fastened to the iron base with angles and wing-nuts, and also carries pin-jack interlocks in series with the snap switch mentioned. Thus the high voltage will be disconnected if the Kinescope or its housing is removed.

The deflecting yoke is supported directly by the Kinescope; felt strips can be used to keep it firmly in place. The yoke is connected to the scanning chassis by a 4-wire cable and plug previously mentioned. Two connections, grid and cathode, are required from the Kinescope to the

◆  
**Fig. 3 — Chassis view of the scanning unit.**  
 ◆





Fig. 7 (above) — Chassis view of the 1801 power supply.  
 Fig. 8 (below) — Rear view of power supply for the 1800. The rectifier tube is enclosed in the cylindrical metal container.

Fig. 9 (top) — Under-chassis wiring in the 1801 power supply. The rectifier tube is mounted horizontally from a bakelite strip.

Fig. 10 (bottom) — Below-chassis view of the 1800 power supply.

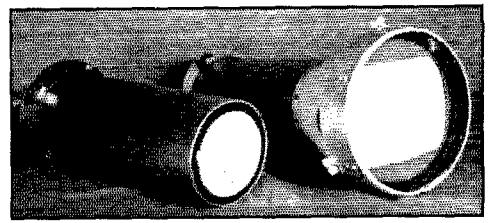
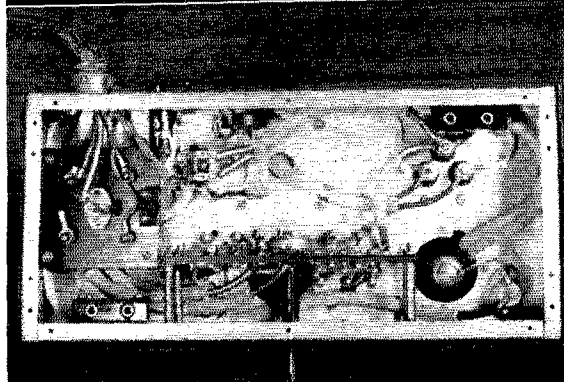
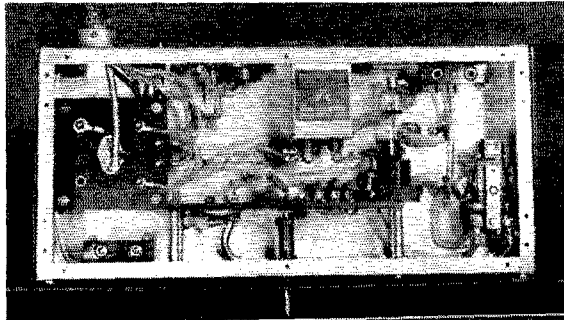

Fig. 11 — The Kinescope assemblies. Seamless iron tubing surrounds the cathode-ray tubes.

video panel; they are made through the porcelain bushings seen in Fig. 12. In order to prevent the possibility of appearance of high voltage at these terminals due to some circuit breakdown, neon lightning arrestors are connected from cathode to ground and grid to ground. These may be seen in Fig. 12. Brach Type 27A arrestors are used, with the clips dismantled from the base

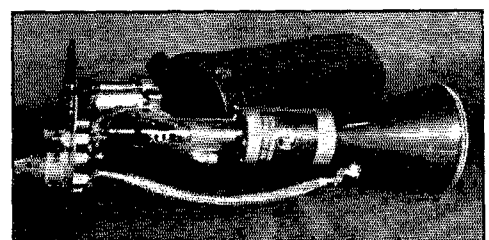

Fig. 12 — The 1801 unit open to show the parts in the assembly.

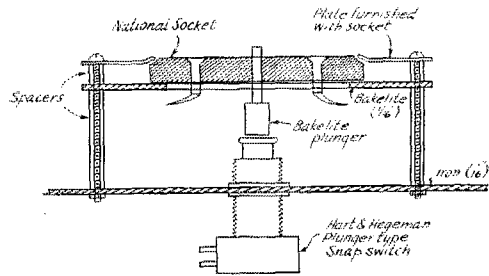

Fig. 13 — Rotatable Kinescope socket with high-voltage disconnect. A plunger-type switch is kept closed so long as the tube is in the socket, but opens the primary circuit of the high-voltage transformer when the tube is removed.

supplied so that no unnecessary capacity is added to the grid circuit. Dismounted, the arrestor with clips has a capacity of about 5  $\mu$ fd.

The function of the scanning unit is to supply linear sawtooth deflecting fields to the Kinescope, and the uniform distribution of a received picture requires this linearity. After the outfit has been built, the linearity of scanning can be checked by the method described in the October

(Continued on page 106)

# Landmark Becomes Ham Emergency Center

**T**HE Smyth observatory tower in Manchester, N. H., has long been a landmark of New Hampshire's largest city. Inspired by his travels in England and Scotland, it was built during 1888-1890 by the Hon. Frederick Smyth, a former governor of the state.

In the intervening years it fell into disuse and the interior was largely destroyed. Two years ago there was a move to have the city take over the observatory and its associated 11-acre tract for a municipal park. The move failed.

Now, however, thanks to W1HPM and his crew of Manchester Radio Club hams, the tower is being renovated and equipped by WPA labor. The object is to make it a headquarters for amateur radio in the city and, for that matter, in the state. Fitted with up-to-date radio equipment, having its own gasoline-engine emergency power supply, the observatory will not only be a luxurious home for the ham club but an emergency communication facility of great potential value to the community.

The project started late last autumn when J. Brodie Smith, W1HPM, backed by the 35 licensed amateurs of Manchester, appeared before the Mayor and Board of Aldermen. He presented a proposition whereby Mrs. Marion C. Smyth, widow of the former governor, offered the land and tower as a gift to the city. The proposal was accepted. Arrangements were then made with the WPA to carry out the work of restoring the interior of the structure. Some 15 to 30 men were taken from relief rolls and set to work during favorable weather. This work was begun in mid-

November and is expected to be completed during February.

Restoration of the tower includes installing new floors, a new roof, stairs, windows and doors. The inside walls are being lined with insulating board. A chimney is under construction, toilet facilities are being installed and an automatic oil burner heating installation is being provided. An automatic pump with 30-gallon tank attached is to be installed in the basement for water supply.

There are three floors and the roof. The basement, of course, houses the pump oil heater and gasoline-driven 115-volt generator. The first floor will be a suitably furnished reception room and lobby. The operating room will be on the second floor, with transmitters covering all amateur bands from 5 meters through 160, 'phone and c.w. The third floor will be used as storage space.

Atop the roof a weather observation station is being installed, to be operated by the 172nd Field Artillery.

The 11-acre site affords plenty of room for antennas. The principal wire will be supported by 60-foot poles, which will bring it well above any land in or near the city of Manchester.

Building activity will not be confined to the tower itself. The road leading to the tower from Smyth road is being rebuilt, a distance of some 600 feet, 16 feet wide, with a gravel surface. The entire site is being cleared and drives and paths are to be established. Then, too, there is the laying of 120 feet of 1¼-inch pipe from the well to the tower.

*(Continued on page 64)*

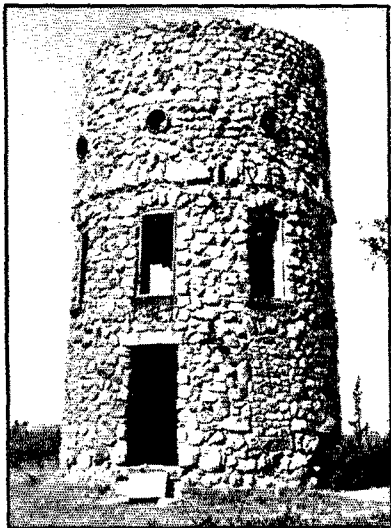

◆  
Left — Smyth tower before restoration.

Right — Artist's conception of the tower when finished.  
◆

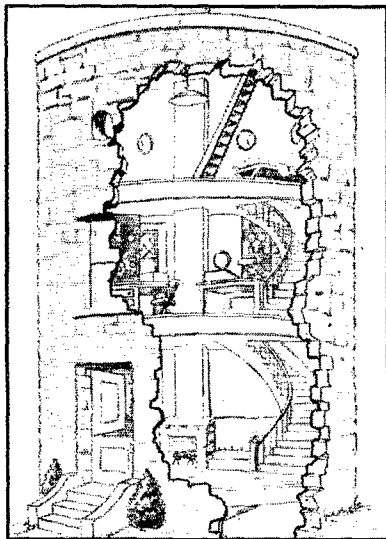



## NAVAL COMMUNICATION RESERVE NOTES

AS OUTLINED in the November issue of *QST*, the United States is divided into Naval Districts. This month's Naval Communication Reserve story is of the First Naval District.

The First Naval District comprises the New England States with the exception of Connecticut. The Naval Communication Reserve in the First Naval District is subdivided into seven sections, each section being composed of several units. At present there is a total of thirty-eight units. The organization covers the major portion of the District, with the largest membership in the coastal areas.

The Naval Communication Reserve Commander, First Naval District, is Lieutenant R. B. Meader, C-V(S), U.S.N.R. (W1KG). The Section Commanders are:

Section I, Maine, Lieut. (jg) L. C. Greene, C-V(S), U.S.N.R. (W1ACF).

Section II, New Hampshire, Lieut. R. T. Smith, C-V(S), U.S.N.R.

Section III, Northern Massachusetts, Lieut. (jg) R. W. Hart, C-V(S), U.S.N.R. (W1AAE).

Section IV, Southeastern Massachusetts, Ensign D. M. Stanier, C-V(S), U.S.N.R. (W1EOZ).

Section V, Cape Cod, Mass., Lieut. A. E. Snow, C-V(S), U.S.N.R. (W1RZ).

Section VI, Rhode Island, Lieut. (jg) H. Young, C-V(S), U.S.N.R. (W1CAB).

Section VII, Western Massachusetts, Lieut. (jg) C. J. Green, C-V(S), U.S.N.R. (W1ASW).

On 1 July, 1938, Lieutenant Meader relieved Lieutenant-Commander C. C. Kolster, C-V(S), U.S.N.R., as N.C.R., Commander, First Naval District. Lieutenant-Commander Kolster devoted himself wholeheartedly and unselfishly for ten years to the work of building up the Naval Communication Reserve in the First District, and has seen it develop from an unorganized group of radio enthusiasts to an efficient and coordinated military command. Though press of business in his capacity as Inspector in Charge, Federal Communications Commission, Boston, Mass., motivated his decision to turn over the command, he is maintaining his interest in the Naval Communication Reserve, and is acting as Liaison Officer on the new Naval Communication Reserve Commander's Staff.

With the expansion of the Naval Communication Reserve, it soon became evident that the administration of this rapidly growing organization was more than a "one-man" job. In 1935, a

staff was formed to aid the N.C.R. Commander. The personnel of the staff has been changed from time to time in order that officers might rotate in the various duties. As of 1 July, 1938, the N.C.R., Commander's Staff is as follows:

Lieut. Comdr. C. C. Kolster, C-V(S), U.S.N.R., Liaison Officer (W1KF).

Lieut. Comdr. W. H. Miller, C-V(S), U.S.N.R., Material Officer.

Lieut. M. D. Chace, C-V(S), U.S.N.R., Personnel Officer.

Lieut. G. L. Burrows, C-V(S), U.S.N.R., Signal Officer.

Ensign R. K. Bullard, C-V(S), U.S.N.R., Operations Officer (W1AN).

Lieut. (jg) N. L. Abbott, C-V(S), U.S.N.R., Assistant Operations Officer (W1ATO).

Lieut. L. G. Cumming, C-V(S), U.S.N.R., Supply Officer (W1FB, W1BV).

Lieut. (jg) A. E. Linell, C-V(S), U.S.N.R., Executive Officer (W1AJK).

All units are active throughout the year. During the nine months period from September 1st to July 1st, the District sponsors an annual radio competition patterned after the National Competition, with a trophy awarded at the conclusion of the active drill season in June. Each year a military drill competition is held, the winner of which receives the District Military Efficiency trophy.

The training program for the Naval Communication Reserve includes not only procedure practice for radio drills but also military drill and instruction in duties on board ship. Active duty at Naval Stations and on board men-of-war is also provided to a percentage of the personnel each year. During this past summer, eight officers and forty-six men of the N.C.R. have performed two weeks of active duty with pay on board the following ships: U.S.S. *Badger*, *Dickerson*, *Hamilton*, *Roper*, *Schenck*, *Tattnall* and *Tillman* — all destroyers of the Training Detachment, U. S. Fleet, and at Naval Radio, Boston, Naval Reserve Aviation Base, Squantum, Mass., and the various Radio Direction Finder Stations of the First Naval District.

The District publishes monthly a paper devoted to the activities of the Communication Reserve, called the *Intercept*. Instructional material, general information regarding the Navy, and

(Continued on page 102)



# Simple Vertical Antennas



BY T. M. FERRILL, JR.\* WILJI



Simple top-load capacity for low-frequency vertical antenna. A four-foot diameter ring of  $\frac{1}{4}$ -inch copper tubing with copper wire spokes forms an effective disc for top-loading capacity.

## Practical Construction Methods for Low- and High-Frequency Bands

**D**URING recent years, little attention seems to have been given vertical antennas, and only in the past few months has interest in them been revived. Probably one large reason for their unpopularity is the vague impression that construction of a vertical antenna involves big pipes and large strain insulators. Also, to obtain a height above ground of  $\frac{1}{4}$ -wavelength (height necessary for resonance of vertical grounded antenna) a structure about 125 feet high is required for the 160-meter band, and one about 65 feet high is required for the 80-meter band.

With the vertical antenna, radiation at low frequencies along the surface of the earth is much increased, while the radiation at high angles which causes fading (and doesn't contribute much toward communication at long or short distances) is greatly reduced. Amateurs 40 to 100 miles apart who have had difficulty with fading interference on 160 and 80 meters can make a large step toward improvement of communication over these distances, as well as over real DX for these bands, by changing to vertical antennas.

The impression that pipes, large rods, or metal trusswork masts are required for vertical antenna installations is incorrect; a wood pole or simple wood structure may be used to support a vertical wire, either from a short horizontal crossarm and insulator, or from a 3- or 4-inch porcelain stand-off insulator mounted directly on the pole. A similar crossarm or insulator may be used at the bottom to keep the wire tight. Since the horizon-

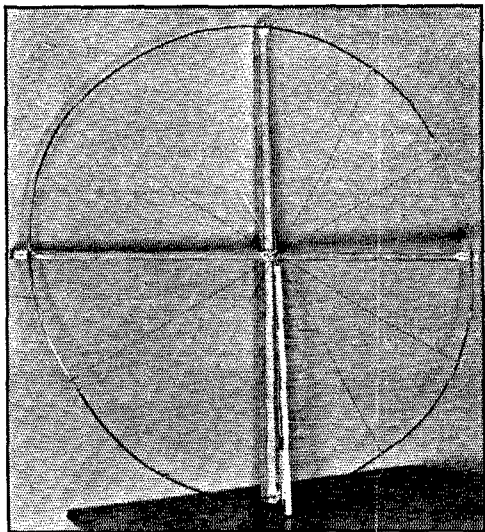

tal pull of the more usual antennas is eliminated with this type, the pole or structure need be only rigid enough to withstand any winds likely to be encountered.

### Antennas for the Low Frequencies

There is an easy way to shorten the required height of 160- and 80-meter vertical antennas to more reasonable heights for amateur installations. Much interest and inquiry was occasioned by the appearance in 1934 of information on use of capacity and inductance top loading to make effective radiators of vertical antennas of  $\frac{1}{4}$ -wavelength and greater heights.<sup>1</sup> The article published at that time, however, dealt more with theory of operation and results obtained, than with practical amateur construction angles.

In Fig. 1 are shown four effective vertical antennas. The antenna of Fig. 1-A is tuned to the transmitter frequency by the series coil and condenser. If the height of the antenna is approximately  $\frac{1}{4}$ -wavelength — about 125 feet for the 160-meter band, 65 feet for the 80-meter band, or 32 feet for the 40-meter band — the coil and condenser connected in series with the antenna and ground will be approximately the values used for a plate tank circuit for the band of operation. If the height of the antenna is less than  $\frac{1}{4}$ -wavelength, the inductance of the coil should be increased well beyond the size of a coil ordinarily used for the band, and the condenser capacity also should be increased.

<sup>1</sup> Nickle, Dome, and Brown, "Control of Radiating Properties of Antennas," *I.R.E. Proc.*, Dec. 1934.

R. B. Dome, "Increased Radiating Efficiency for Short Antennas," *QST*, Sept. 1934.

\* Technical Department, *QST*.

### Top-Loaded Systems

The odd-looking combination of Fig. 1-B is a "top-loaded" antenna — one in which a lumped capacity is supported at the top of the antenna, and connected to it through a coil. The capacity provided by an open disc and the inductance connected in series effectively lengthen the antenna to a quarter-wave height just as does additional capacity and inductance at the base of the antenna of Fig. 1-A. The effect on the current in the antenna produced by the top load is markedly different from that produced by the bottom loading, however, and is much more favorable. Furthermore, top loading decreases the flow of current between the antenna coupling coil and ground, and thus decreases the ground resistance loss. Experiments<sup>1</sup> have shown field strength obtained with a top-loaded antenna  $\frac{1}{4}$ -wave high approximately equal to that obtained with the more conventional type (that of Fig. 1-A)  $\frac{1}{4}$ -wave high. For 160-meter band operation, this means a height of 50 feet instead of 125 feet.

### Construction of Loading Capacitor

Capacity for top loading may be provided by a circle of  $\frac{1}{4}$ -inch copper tubing to which are soldered radial wires. The illustration shows a unit designed for loading a 160- and 80-meter vertical antenna 50 feet high. Capacity of approximately 40  $\mu\text{mfd.}$  is obtained with a diameter of slightly less than four feet for the effective disc. A piece of  $\frac{1}{4}$ -inch copper tubing approximately 12 feet long is bent into a circle with four flattened points drilled for the top screws of

$1\frac{1}{2}$ -inch porcelain standoff insulators. Two joined 4-foot pieces of 1-inch by 2-inch pine provide the rigid backbone and mounting for the capacitor, and five insulators are mounted on the ends and the center of the crossed pieces. The center insulator holds soldering lugs to which are brought twelve 14-gauge wires from soldered points evenly spaced around the circle. This junction is also used as the terminal for connection of the antenna or the load coil.

For 160-meter operation of a 50-foot antenna with this capacitor, a coil of 65 turns of 14-gauge wire, spaced wire diameter on a 5-inch diameter form, should be used. Such a coil may be wound on celluloid sheet slipped over a large mailing tube. For 80-meter operation of the same antenna, a 30-turn coil otherwise similar to the above may be used. A weatherproof housing of metal or other material should be used to protect the coil.

If the provision for adjustment of the loading inductance from the ground is desired, a second wire spaced three to eight inches from the radiator may be used, with upper end making no connection. The proper spacing may be maintained with feeder separators; the 6-inch commercially available spreaders are excellent for this purpose. For antenna heights of  $\frac{1}{4}$ - to  $\frac{1}{2}$ -wavelength, an inductance should be connected between the lower ends of the two wires, and the inductance may then be adjusted readily without taking down the antenna. This arrangement is shown in Fig. 1-C.

### Adjustment of Top-Loaded Antenna

Adjustment of the antennas of Fig. 1-B and -C

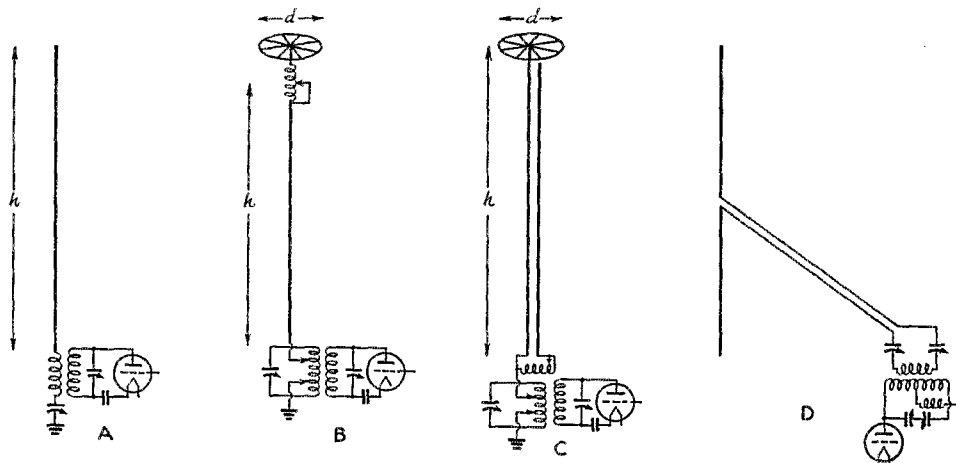

Fig. 1 — Vertical Antennas.

A simple grounded type antenna is shown at A, while shortened antennas with top-loading inductance and capacity are shown at B and C. The system of C uses an inductance connected between the foot of the antenna and a spaced wire to effectively insert inductance in the radiator, thus making possible adjustments of the loading inductance from the ground. Whereas the antennas of A, B, and C are best suited for 160-, 80-, and 40-meter operation, that of D is an excellent antenna for 40-, 20-, and 10-meter work. Any of the antennas shown may be used for 2-band operation, and satisfactory operation on 3 bands is provided by that of D if the feeders are longer than half the height of the radiator.

is slightly less convenient than that of other antenna types. Instead of using instruments connected directly to the antenna, the operator must rely on cooperation of a friend with a meter or tuning-eye-equipped receiver 200 to 1000 feet from the antenna. Just enough wire should be connected to the antenna post of the receiver to give a low signal strength reading from the antenna with the inductance shorted, and the assistant, who may be a

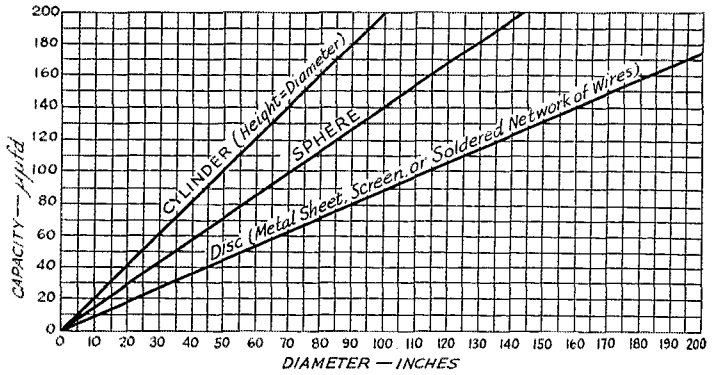

Fig. 2 — Capacity of metal objects suspended well above the ground. Probably the simplest to construct is a tubing-and-wire network similar to that of the illustration.

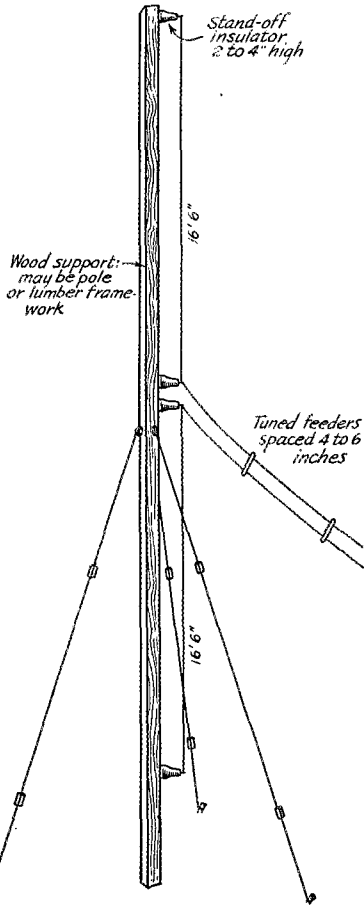

Fig. 3 — An effective vertical antenna for operation in the 20- and 10-meter bands.

This easily-built antenna operates as a half-wave antenna on 20 meters and as two half-waves in phase on ten meters. Good operation on 40 meters with these dimensions is made possible if the feeder length is sufficient to supply the additional quarter-waves of loading.

“non-radio-minded” friend, should be instructed to report the effects of changes in adjustment on the transmitting antenna. The assistant should be warned to make no changes in the receiver adjustment during the tests. With this set-up in operation, and the antenna coupling tank circuit tuned to resonance and coupled to load the transmitter properly, the clip on the antenna inductance should be removed from the position of coil shorting and replaced to connect a few turns of the coil in the circuit. With the antenna coupler adjusted for resonance and correct transmitter load, the second receiver reading should be obtained from the assistant. The operations should then be repeated with a few more turns of the antenna loading inductance connected in the circuit, and so on. When an increase of the inductance in the circuit is found to cause a drop in the signal strength at the receiver, the tap should be moved back a few turns for slightly less inductance, and left in this position. The point on the coil should be marked, so that one adjusting process will serve for all operation on the band on which the adjustment is carried out.

#### Good Ground Connection Important

Although this system has as one of its major advantages the effect of decreasing the current to ground and thus the ground connection resistance loss, at least one iron or copper pipe, and preferably three or four, should be driven in the ground to a depth of a few feet and connected with low-resistance contacts to the point shown in the diagram of Fig. 1-B or -C. The hours spent in construction and adjustment of this system for 160- and 80-meter operation are more than justified by the excellent performance shown by the antenna.

#### Link Coupling the Transmitter

It will be noted that in Fig. 1-A, -B, and -C, the coupling coil of the antenna is shown coupled

(Continued on page 90)

# An Economical Six-Band Transmitter

*A Two-Tube R.F. Circuit for Either C.W. or 'Phone*

BY HAROLD ROBERTS,\* W1KUK

**M**ANY are the hams who day dream during classes or business hours about building a rig for all bands, only to be rudely awakened by the fact that the wide open spaces of their pocket-books won't permit it. I know, for I too was aroused from much peaceful slumber.

However, after much experimenting, a circuit was finally arrived at that incorporates efficiency, flexibility and economy. The lineup simply consists of two stages, an RK49 oscillator driving a TZ20.

## The Oscillator

As the diagram, Fig. 1, shows, the RK49 can be used in three different circuits: (1) as a tetrode crystal oscillator, (2) as a Tri-tet oscillator, and (3) as an electron-coupled oscillator. To switch over from Tri-tet to tetrode, one need only close the cathode condenser, which shorts itself out since a corner of one of the plates is bent. A plug switching system made up of banana plugs and jacks mounted on bakelite was installed in the cathode circuit. Thus, to switch over from crystal to e.c.o., one simply changes the position of one of the plugs and substitutes a small condenser, C<sub>10</sub>, in place of the crystal.

The correct amount of output with minimum crystal current is obtained by choosing the proper value of screen voltage for the RK49. This is accomplished by means of a potentiometer, R<sub>3</sub>, placed in the screen circuit. The method of adjustment is described later.

## The Amplifier

The TZ20 in the final stage is used as a straight amplifier from 160 to 10 meters inclusive, and as a doubler on 5 meters. The balanced output circuit uses a split-stator condenser that was rebuilt

\* 56 Center St., West Haven, Conn.

from an unused General Radio condenser. The original condenser had 500- $\mu$ fd. capacity; splitting it in two resulted in 250 on each side, which, with the sections in series, results in a total of 125  $\mu$ fd. Nearly every ham's junk box contains a similar condenser which can readily be changed into a split-stator. The only equipment needed is a hack saw and a supply of "elbow grease." The minimum capacity of the condenser is quite low, which permits a good L/C ratio to be obtained on 5 meters.

When the transmitter is used on c.w., the key and the keying r.f. filter or lag circuit are connected in series with the TZ20 filament center-tap. This type of keying was found to be highly satisfactory and adds to the stability of the rig since the oscillator operates continuously. Fixed battery bias is used on the amplifier, and its plate current drops to zero when the key is opened.

## Operation

The efficiency of a straight amplifier is approximately 70 per cent and that of a doubler about 33 per cent. In view of this fact, the TZ20 is made to double only when five-meter operation is desired. If a ten-meter crystal is available, the tube can operate as a straight amplifier on 56 Mc.

When operating the oscillator in the electron-coupled circuit, greater frequency stability is obtained if the plate circuit is tuned to the second harmonic. We wish to emphasize the fact that the greatest care must be exercised when one adjusts and operates a self-excited oscillator, especially on 'phone. Many beginners attempt to use self-excited signals without the use of a good monitor and an accurate frequency meter, thereby needlessly jeopardizing their amateur privileges.

Following is the method of operation on the various bands. On 1.75 Mc., a 1.75-Mc. crystal

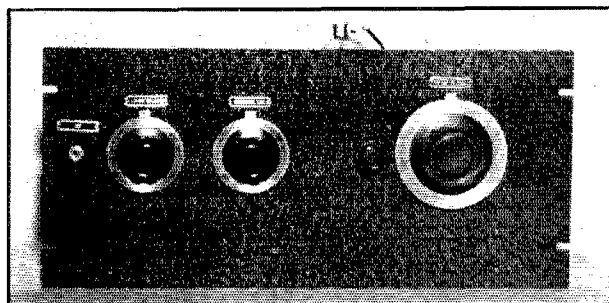

◆  
This simple six-band transmitter fits nicely, without crowding, behind a standard 3 $\frac{3}{4}$ -by-19-inch relay rack panel. The three tuning controls are, from left to right, the oscillator cathode condenser, oscillator plate tank condenser, amplifier plate tank condenser.  
◆

The chassis layout is straightforward, as shown by this rear view. The jack strip in the cathode circuit is mounted on small standoffs at the extreme right. The other top-of-chassis components are easily identified.

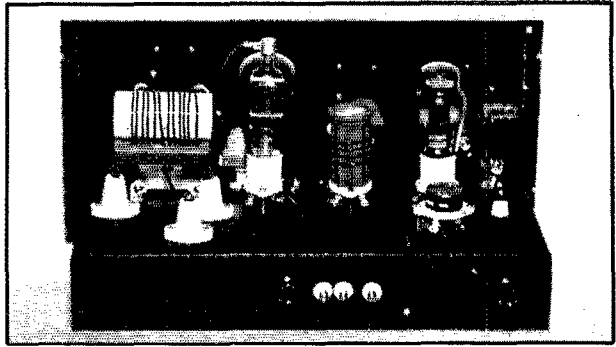

is used in the tetrode crystal circuit. The electron coupled oscillator also can be used. This is the only band, however, where the grid circuit of the e.c. oscillator is tuned to the operating frequency. On 3.5 Mc., a 1.75-Mc. crystal is used, with doubling in the plate circuit of the Tri-tet oscillator. The e.c.o. may be used with the grid circuit of the oscillator tuned to 1.75 Mc. and the plate circuit doubling to 3.5 Mc. On 7 Mc., a 3.5-Mc. crystal may be used in the Tri-tet circuit, doubling in the plate of the oscillator. Also, a 7-Mc. crystal may be used in the tetrode circuit. The e.c.o. may be used with the grid circuit tuned to 3.5 Mc. and the plate circuit doubling. On 14 Mc., a 7-Mc. crystal is used in the Tri-tet circuit, doubling in the plate of the oscillator. Alternatively, a 14-Mc. crystal may be used in the tetrode circuit. For e.c., the grid circuit is tuned to 7 Mc., and the plate circuit of the oscillator is tuned to 14 Mc. For 28-Mc. operation, a 14-Mc. crystal is used in the Tri-tet circuit, doubling in the oscillator plate. On 56 Mc., the 14-Mc. crystal again is used, doubling in the plate circuit of the Tri-tet oscillator and doubling once more to 56

Mc. in the TZ20 amplifier. If a 28-Mc. crystal is available, it could be used in the Tri-tet circuit, doubling to 56 Mc. in the oscillator plate circuit.

The method of adjusting the screen voltage of the oscillator is as follows: First, raise the screen voltage to a high value by means of the potentiometer. Then tune up the transmitter in the usual manner. The oscillator should be tuned for highest TZ20 grid current. The screen potentiometer should then be turned in the high resistance direction until the amplifier grid current drops to normal (17 ma. for c.w. operation and 22 ma. for 'phone) with the TZ20 loaded to its normal plate current of 75 ma. As the screen voltage is lowered, the crystal current will drop appreciably.

A link coupling system of about 2 turns on each end is used between the final tank and the antenna tuning unit.

Coil data are given in the accompanying table. When using the electron-coupled oscillator, the exact location of the tap on the grid coil is a matter of cut-and-try. The tap should be moved toward the ground end of the coil to a point just above where the output of the oscillator

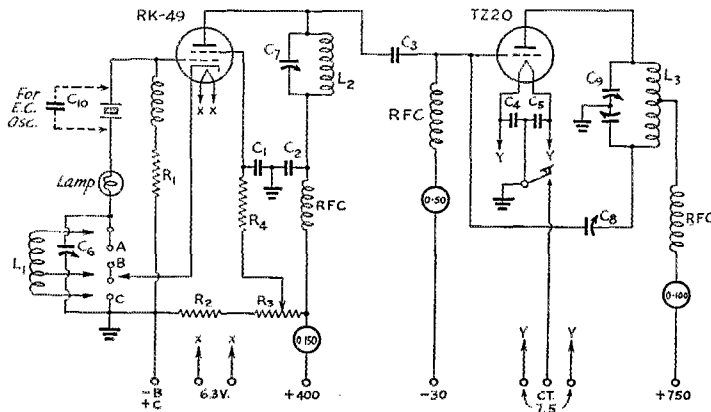

Fig. 1 — Circuit diagram of the two-tube six-band transmitter.

- C<sub>1</sub> — 0.005  $\mu$ fd., 400-volt.
  - C<sub>2</sub> — 0.002  $\mu$ fd., 600-volt.
  - C<sub>3</sub> — 100  $\mu$ fd., 1000-volt.
  - C<sub>4</sub>, C<sub>5</sub> — 0.006  $\mu$ fd., 400-volt.
  - C<sub>6</sub>, C<sub>7</sub> — 100- $\mu$ fd. variable.
  - C<sub>8</sub> — 8- $\mu$ fd. variable.
  - C<sub>9</sub> — Split-stator, 200 to 250  $\mu$ fd. per section.
  - C<sub>10</sub> — 250- $\mu$ fd. mica.
  - R<sub>1</sub> — 50,000 ohms, 2-watt.
  - R<sub>2</sub> — 50,000 ohms, 10-watt.
  - R<sub>3</sub> — 50,000-ohm potentiometer, to carry 7-10 ma.
  - R<sub>4</sub> — 5000 ohms, 5-watt.
  - RFC — 2.5-mh. r.f. chokes.
- See table for coil data.

The cathode plug is inserted in jack B for e.c. operation and in jack A for Tri-tet. The cathode is connected to ground when the plug is in C; the same connection can be made by bending over one plate of C<sub>6</sub>, so that it shorts when set to maximum capacity, leaving the plug in A for quick change from tetrode to Tri-tet crystal oscillator.

COIL DATA			
Band	L <sub>1</sub> Diam. 1½ inches	L <sub>2</sub> Diam. 1½ inches	L <sub>3</sub> * Diam. 1¾ inches
1.75 Mc.	25 turns No. 18, closewound, tap 8 t. from ground for e.c.	50 turns No. 22, closewound	45 turns No. 16, closewound
3.5 Mc.	10 turns No. 18, length 1 inch, e.c. tap 3 t. from ground	25 turns No. 18, length 1½ inches	25 turns No. 14, closewound
7 Mc.	6 turns No. 18 length 1 inch, e.c. tap 2 t. from ground	17 turns No. 18, length 1½ inches	16 turns No. 12, length 2½ inches
14 Mc.		8 turns No. 18, length 1½ inches	10 turns No. 12, length 2 inches
28 Mc.		4 turns No. 18, length 1½ inches	5 turns No. 12, length 2 inches
56 Mc.			2 turns No. 12, length 2 inches

\* Wound on National XR-13 forms.

drops below the required value. The lower the tap, the greater is the stability of the oscillator.

When switching over from 'phone to c.w. one must not forget to short out the secondary of the modulation transformer since the energy stored in it would cause arcing in the plate circuit of the final stage.

With normal input to the TZ20, a power output of about 40 watts is obtained on all bands except 56 Mc., where the output as a doubler is about 20 watts.

## New Apparatus

### Concentric Transmission Line

A NEW type of construction using spun glass spirally wound on inner conductor is the feature of a new concentric transmission line, No. 600, made by Communication Products, Inc.

This line incorporates No. 16 gauge copper wire in a ¼-inch outside diameter copper tube, with a dielectric constant of 6.3 at 1 Mc. and characteristic impedance of 70 ohms. The power handling capability of the cable is 300 watts maximum transmitter output. An interesting feature of this type of construction is the fact that such a small diameter concentric line is suitable for a bend of three-inch radius, a point which makes it extremely attractive for difficult installations.

Thus the efficiency of a 100-foot length of this line is approximately 80 per cent at 30 megacycles.

Loss figures are given by the manufacturer as follows:

## 1.75-Mc. W.A.S. Party!

Feb. 18th-19th

HERE'S an activity designed especially for our 160-meter brothers. It's a fraternal activity for testing stations and giving the band a thorough workout. You can see for yourself how many states can be worked in a given time using a transmitter on the 160-meter band only. *Rules.* Simplicity is the watchword. Work other 160-meter stations; exchange signal reports and the name of the state you are located in. List in three columns the *time*, the *call* of the station worked, and his *state*. These facts can be cross checked as logs are received at Hq., of course. A given station may be worked but once for contest credits.

Add the number of stations, or count *one each* for contacts, and multiply the result by the number of *different states* worked. (The District of Columbia will also count for Maryland.) This product will be your score. The activity is open to all amateurs, wherever located.

All contest or party operations must take place in *any twenty* hours of the following 33-hour period:

### 160-METER PARTY

Starts	Ends
3 P.M. PST, 4 P.M. MST,	12.01 A.M. PST, 1.01
5 P.M. CST, or 6 P.M.	A.M. MST, 2.01 A.M.
EST, SATURDAY,	CST or 3.01 A.M. EST,
Feb. 18th	MONDAY, Feb. 20th

There's been a deplorable tendency to under-rate the capabilities of the 1715-2000-ke. amateur band. This last month proved that some of our stations on "160" could be heard in England, and we feel sure that a surprising number of states can be "bagged" in a little party dedicated to that worthy purpose. Let's all give it a whirl, and let's know how you make out.

— F. E. H.

Frequency in Mc.	Db Loss Per 100 Ft.
0.5	0.12
1	0.19
3	0.32
5	0.41
10	0.60
20	0.84
30	1.00
60	1.50

This new transmission line is available with end seals which include ceramic-insulated binding post terminals for center conductor. The impedance value makes it an excellent match for center connection to half-wave radiators.

T. M. F.

# Navy Day—1938

## Radio Amateurs Participate in Annual Celebration

1938 was the fourteenth consecutive year in which amateur radio operators of the United States participated in the celebration of Navy Day, October 27th. On this day each year A.R.R.L. has staged a Receiving Competition, consisting of a message from the Secretary of the Navy, with awards to those making the most accurate copy.

In the 1938 competition the Navy Department offered letters of appreciation to those operators making perfect copy. The message was transmitted from Radio Washington (NAA) and Radio San Francisco (NPG) at a speed of 25 w.p.m. 647 operators submitted copies, 33 per cent of them with 100 per cent accuracy. The percentage of perfect copies is considerably lower than for the 1937 competition (57 per cent), due probably to an increase in length of the message and speed of transmission.

The Secretary's message was copied in 44 states, the District of Columbia, Alaska, Hawaii, Canal Zone, Cuba, Puerto Rico, and four Canadian provinces. A table showing participation by Naval Districts, indicating number of N.C.R. members submitting copies, etc., is presented for the general information of all and to show the relative standings of the various Districts. 56 per cent of all participants were members of the Naval Communication Reserve.

The Honor Roll lists all contestants by Naval Districts in the order of rating within their re-

(Continued on page 112)

### 1938 NAVY DAY MESSAGE

This year in celebration of Navy Day it is again my pleasure to transmit a message of greeting to the radio operators of the United States and of our insular possessions. In all Naval Districts the Naval Reserve has opened its Reserve Air Bases and Armories to the public in celebration of Navy Day and a number of Air Squadrons and Divisions of the Naval Reserve have engaged in aerial exercises and parades which have been carried out based upon commands transmitted over Naval Reserve radio circuits from Washington to certain Naval Districts. This is the first time that our Reserve radio training circuits have been used as command circuits indicating the great progress that has been made by the Communication Reserve in its knowledge of Naval radio communication procedure. With conditions disturbed abroad the Navy Department is well pleased to know that we have available in case of need a large force of communication experts whose services are also available when needed in connection with emergency communication for the Red

Cross when hurricanes and other disasters occur. I extend again the best wishes of the Navy Department to our American radio operators.

CLAUDE A. SWANSON  
Secretary of the Navy

(This is the text of the message transmitted from NPG. NAA's text was a paraphrase of NPG's.)



Naval District	Number of Participants			Number Making Perfect Copy			% Perfect Copies	Number of Copies Submitted		
	N.C.R. <sup>1</sup>	Non-N.C.R. <sup>1</sup>	Total	N.C.R. <sup>1</sup>	Non-N.C.R. <sup>1</sup>	Total		Of NAA	Of NPG	Total
First .....	18	21	39	4	5	9	23	39	1	40
Third .....	45	51	96	16	17	33	34	86	13	99
Fourth .....	41	24	65	9	13	22	34	63	4	67
Fifth .....	16	14	30	6	5	11	37	25	5	30
Sixth .....	8	6	14	3	3	6	43	11	3	14
Seventh .....	19	6	25	8	1	9	36	24	1	25
Eighth .....	27	24	51	11	5	16	31	41	13	54
Ninth .....	72	63	135	16	23	39	29	119	26	145
Eleventh .....	32	19	51	14	5	19	37	2	51	53
Twelfth .....	48	30	78	21	11	32	41	3	78	81
Thirteenth .....	34	15	49	7	5	12	24	4	45	49
Fourteenth .....	1	3	4	1	1	2	50	..	4	4
Fifteenth .....	2	..	2	2	..	2	100	2	..	2
Miscellaneous .....	1	7	8	..	3	3	37	4	4	8
Totals .....	364	283	647	118	97	215	33	423	248	671

<sup>1</sup> The number of N.C.R. and non-N.C.R. member participants was determined as accurately as possible by examination of copies received.

# Factors Influencing the "Q" of R.F. Coils in Amateur-Band Receivers<sup>1</sup>

**Effects of Wire Size, Length/Diameter Ratio, Dimensions, Winding Forms and Insulation**

★  
BY DALE POLLACK \*  
★

It is well known that the performance of radio equipment, particularly of receivers, is dependent upon the merit of the coils employed in the tuned circuits. The quality of a coil is most conveniently expressed in terms of its ratio of reactance to resistance, denoted by  $Q$ , or, symbolically,

$$Q = \frac{X}{R}$$

The higher the  $Q$  of a coil, the lower its resistance, and, in general, the better is the coil.

The use of high  $Q$  coils in receivers is desirable for at least two reasons. The first, and most apparent, reason is that the voltage amplification of a radio frequency amplifier is directly dependent upon the  $Q$  of the coils in the tuned circuits. The second reason, which is perhaps more important than the first, is that the selectivity of the amplifiers is largely determined by the  $Q$  of the inductances. One of the defects encountered in most superheterodyne receivers at frequencies above 2 or 3 megacycles is the lack of selectivity ahead of the first detector, where, usually, only two tuned circuits are found. When such selectivity is inadequate, the image response of the receiver, caused by unwanted signals on the wrong side of the oscillator frequency, is excessive and the operation of the receiver is correspondingly impaired. In addition, the noise output of the receiver is directly related to the pre-mixing selectivity.

Very little information is available in the literature upon which to base the design of coils for use at frequencies above the broadcast band. What little work has been done has not been correlated and arranged for convenient use for design

purposes. The author, consequently, recently undertook a study of high-frequency inductances with the view of obtaining and presenting this information. The results of this study, insofar as they apply to the design of coils for amateur band receivers, are given here.

The value of the inductance,  $L$ , is determined by circuit considerations, such as the frequency range to be covered, and therefore is fixed by specification. The data presented here are concerned mainly with the  $Q$  of the coil. The highest  $Q$  consistent with practical limitations — such as those of cost and space — is the desideratum. The magnitude of the coil losses is determined by the construction, the factors which should be considered in designing a coil being:

1. Coil dimensions: length and diameter.
2. Wire: material, insulation, and size.
3. Coil form: material, insulation, and size.
4. Location of coil with respect to metallic and dielectric bodies.

The design problem is to proportion these factors so that the resistance of the coil will be minimum.

A large number of tests were made and these tests were correlated with mathematical analysis to deduce general rules for the design of coils. The investigation was confined to small single-layer solenoids of the type commonly employed in high-frequency receivers. The results of the study which are of interest to amateur band receiver designers are summarized in the following paragraphs. For the usual types of coils these conclusions may be applied to the frequency range between 4 and 25 megacycles, which includes some of the most important amateur bands.

## Wire Size

An experimental set of curves illustrating the variation in  $Q$  with wire size is shown in Fig. 1.

\* Transmitter Dept., RCA Manufacturing Co., Inc., Camden, N. J.

<sup>1</sup> Some of the information contained in this article is from a paper entitled "The Design of Inductances for Frequencies between 4 and 25 Mc.," published in *Electrical Engineering* for September, 1937, and in the *RCA Review* for October, 1937. The experimental work involved in the study was carried out in the Marcellus Hartley Laboratory of the Electrical Engineering Department of Columbia University.

This article provides the answers to some of the questions commonly asked on the subject of what one should do to make a good coil. Definite, and simple, rules for the construction of coils having maximum  $Q$  for a given value of inductance are given. The author indicates where it is possible to compromise without unduly reducing the merit of the coil. Frequencies considered range through 25-Mc. band.



The optimum wire size, as obtained by calculation,<sup>2</sup> is

$$d_o = \frac{b}{\sqrt{2N}} \quad (1)$$

The wire, therefore, should be spaced to occupy approximately 0.7 of the total winding length. The test coils were wound on bakelite forms with enameled wire, typical of the construction used in practice. In most cases a good experimental agreement with equation (1) was found, and it may be concluded, therefore, that there is an optimum size of wire for any given coil, whose value is readily computed. The curves indicate, also, that the value is not critical and some departure from the optimum may be made without materially reducing the  $Q$ .

### Length/Diameter Ratio

The determination of the proper ratio of length to diameter is more difficult. Wide variations in conclusions on this point have been reached by various investigators. The apparent inconsistencies result from the fact that different variables are considered in different studies. The solution which is reached must always depend upon the geometric or economic limitations which are assumed. The coil volume, surface area, wire length, or any of several other factors may be assumed constant, depending upon the nature of the problem. It should also be noted that either the wire size may be kept constant or the optimum value may be employed, although for design purposes the latter is preferable.

The effect of changes in ratio of coil length to diameter, for a certain group of coils in which the coil diameter, wire size, inductance, and frequency are held constant, is shown in Fig. 2. A

<sup>2</sup> For details of the analysis reference should be made to the original paper. See Footnote 1.

similar set of curves, except that the coil length is held constant, instead of the diameter, is given in Fig. 3. For the specifications for which these curves are obtained, namely, the wire size, inductance, frequency, and either the diameter or length constant, it appears that the optimum ratio of length to diameter is between 0.5 and 0.3.

### Coil Dimensions

It should be noted particularly that in the curves of Figs. 2 and 3 the wire size was kept constant. For design purposes the variation in  $Q$  with the coil dimensions, when the optimum wire size of equation (1) is used, is of greater importance, since higher  $Q$ 's may be obtained in this way. It has been found that the coil  $Q$  is proportional to

$$Q'_m = \frac{D}{102 + \frac{45}{S}} \quad (2)$$

provided that the wire size is maintained at the optimum value. This equation is plotted in Figs. 4 and 5. Fig. 4 illustrates how the  $Q$  varies with length and diameter of the coil and Fig. 5 shows the variation in  $Q$  with the length/diameter ratio for a constant coil diameter. In the derivation of this relationship the effect of radiation was neglected and consequently equation (2) holds only when the maximum coil dimension is very small compared with the wavelength at which the coil is to be used.

It appears from equation (2) and from Fig. 4 that, when no economic limit is placed upon the coil dimensions, the  $Q$  increases as the diameter and length of the coil are increased. For a constant diameter of coil the  $Q$  increases with increasing coil length, but the increase is less rapid as large values of  $b/D$  are obtained. If the  $b/D$  ratio is kept constant, the  $Q$  increases directly as the diameter of the coil.

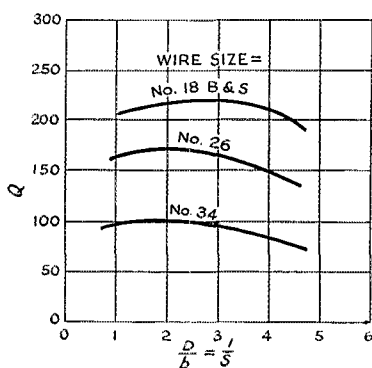
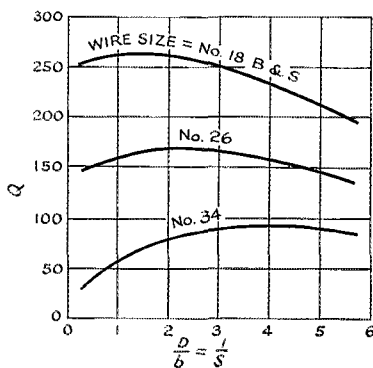
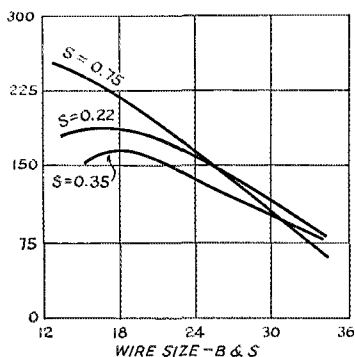

Fig. 1 — Experimental curves illustrating variation in  $Q$  with wire size. For this set of curves,  $f=20$  megacycles,  $L=1.1$  microhenrys,  $D=2.5$  centimeters.

Fig. 2 — Experimental curves illustrating the variation in  $Q$  with coil diameter/length ratio, when the diameter is constant. For this set of curves,  $f=17$  megacycles,  $D=2.5$  centimeters,  $L=1.1$  microhenrys.

Fig. 3 — Experimental curves illustrating the variation in  $Q$  with coil diameter/length ratio, when the length is constant. For this set of curves,  $f=13$  megacycles,  $b=1.5$  centimeters,  $L=3.6$  microhenrys.

Frequently, the maximum coil dimensions are fixed by the size of the coil shield, which, in turn, is limited in size by the space available in the apparatus. The presence of a coil shield usually reduces the  $Q$ , because of the increased eddy current loss. It has been shown by several experimental and mathematical studies that, if the coil diameter is less than half the shield diameter, and the ends of the coil are separated by at least a coil diameter from the ends of the shield, the  $Q$  of the tuned circuit is not reduced by more than 5 to 8 per cent. This restriction may be employed to determine the size of a coil enclosed in a shield.

### Number of Turns

The number of turns, for a given inductance, when the diameter and length of the coil are known, can be calculated from

$$N = \sqrt{\frac{L(102S + 45)}{D}} \quad (3)$$

This equation will usually give the correct value within about 5 per cent and the coil, when wound, can be adjusted to the required value in any of the

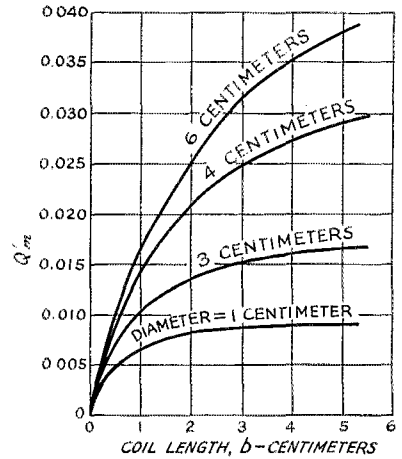

Fig. 4—Plot of equation (2), showing the variation in  $Q$  with length and diameter of coil, when the wire size is kept at the optimum value.

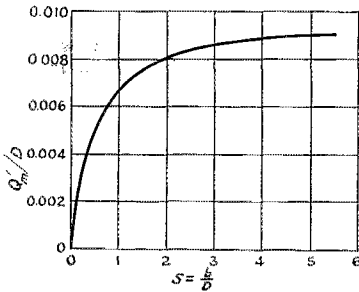

Fig. 5—Plot of equation (2) showing the variation in  $Q$  with the length/diameter ratio, when the wire diameter is optimum and the coil diameter is constant.

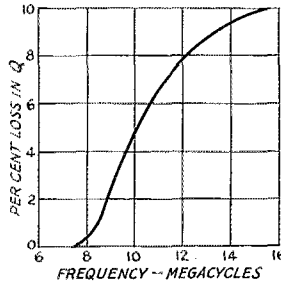

Fig. 6—Per cent loss in  $Q$  resulting from grooved bakelite form. For this figure,  $L=3.6$  microhenrys,  $D=2.5$  centimeters,  $b=1.5$  centimeters; wire size, No. 18 B. & S.

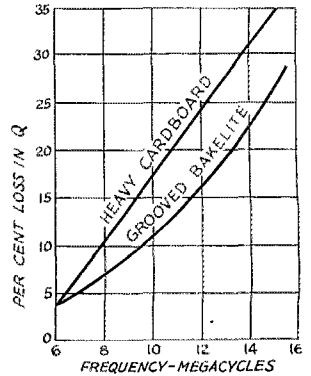

Fig. 7—Per cent loss in  $Q$  resulting from heavy cardboard form and grooved bakelite form. For this figure,  $L=3.6$  microhenrys,  $D=5$  centimeters,  $b=1.5$  centimeters; wire size, No. 32 B. & S.

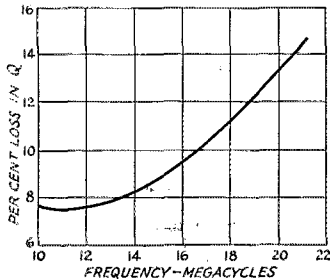

Fig. 8—Per cent loss in  $Q$  resulting from groove in bakelite form. (No measurable loss resulted from the use of a smooth bakelite form.) For this figure,  $L=1.1$  microhenrys,  $D=2.5$  centimeters,  $b=1.9$  centimeters; wire size, No. 14 B. & S. Groove approximately 0.04 centimeter deep.

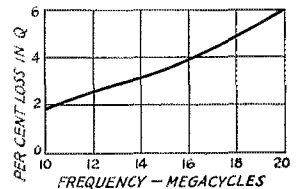

Fig. 9—Per cent loss in  $Q$  resulting from enamel wire insulation. For this figure,  $L=1.1$  microhenrys,  $D=2.5$  centimeters,  $b=3.4$  centimeters; wire size, No. 18 B. & S.

### LIST OF SYMBOLS

- $b$  = length of winding, cm.  
 $\bar{d}^0$  = optimum wire diameter, cm.  
 $D$  = winding diameter, cm.  
 $L$  = inductance of coil, microhenrys.  
 $N$  = total number of turns.  
 $Q$  = figure of merit of coil =  $\frac{X}{R}$ .  
 $Q^*$  = factor proportional to the  $Q$  when optimum wire size is used.  
 $R$  = effective series resistance of coil.  
 $S = \frac{b}{D}$  = ratio of length to diameter of coil.  
 $X$  = reactance of coil, ohms.

usual ways. The "Lightning Calculator," which is familiar to most amateurs, is also convenient for computing the number of turns and may be used instead of equation (3).

### Dielectric Losses

The magnitude of the dielectric losses in the coil form and in the enamel wire insulation for typical coils at high frequencies was investigated. Examples are given herewith. To measure the dielectric losses in the coil form two similar coils of 2.5-centimeter diameter were wound, one using a grooved bakelite form with a groove about 0.04 centimeters deep, the other wound self-supporting, except for three narrow celluloid strips to which the wire was fastened with collodion. The percentage loss in  $Q$  resulting from the grooved bakelite form is shown in Fig. 6. At 14 megacycles, the loss is less than 10 per cent.

The curves of Fig. 7 are for a set of three similar coils, of 5-centimeter diameter, one wound without any supporting material — similar to the coil described in the preceding paragraph — one wound on a grooved bakelite form, and the third on a grooved cardboard form about one centimeter in thickness: worse than any case one would expect to find in practice. The groove in each case was about 0.04 centimeter deep. At 13 megacycles the reduction in  $Q$  resulting from the heavy cardboard form was 27 per cent. A wood form, used for another coil, gave results similar to those obtained for the cardboard. The loss in  $Q$  resulting from the grooved bakelite form was 19 per cent at 13 megacycles.

To measure the dielectric loss in the coil form at higher frequencies, a group of 1.1-microhenry coils was wound, one on a smooth bakelite form, one on grooved bakelite with a groove about 0.04 centimeter deep, and one without a supporting form, as described previously. The difference between the smooth bakelite and the air-core samples was smaller than the experimental error. The loss in  $Q$  resulting from the groove in the bakelite is plotted in Fig. 8, and amounts to 13 per cent at 20 megacycles.

To investigate the dielectric loss in the enamel wire insulation, two similar coils were wound, on smooth bakelite forms, one using enameled wire, the other bare copper wire carefully cleaned to remove corrosion. The per cent loss in  $Q$  resulting from the enamel is plotted in Fig. 9 and amounts to about 6 per cent at 20 megacycles. This result is quite reasonable, since the dielectric path in a spaced winding is largely in air. Below 5 megacycles the dielectric loss in the wire insulation is difficult to detect. After a time bare copper wire corrodes and the dielectric loss in the enamel insulation may become smaller than the loss resulting from corrosion.

These data indicate the relative unimportance of the dielectric losses in determining coil performance. The choice of coil-form material, within reason, and the use of enameled wire have little effect on the merit of the coil. A loss of less than 10 per cent or 20 per cent can be expected for small diameter coils, if a deeply grooved form is used. A shallower groove may be used with little sacrifice in rigidity and an improvement of a few per cent in the figure of merit. An ungrooved bakelite form causes very little loss in  $Q$  up to 20 megacycles.

## A.R.R.L. QSL Bureau

FOR the convenience of its members, the League maintains a QSL-card forwarding system which operates through volunteer "District QSL Managers" in each of the nine United States and five Canadian districts. In order to secure such foreign cards as may be received for you, send your district manager a standard No. 10 stamped envelope. If you have reason to expect a considerable number of cards, put on an extra stamp so that it has a total of six-cents postage. Your own name and address go in the customary place on the face, and *your station call should be printed prominently in the upper left-hand corner.*

- W1 — J. T. Steiger, W1BGY, 35 Call Street, Willimansett, Mass.
- W2 — H. W. Yahnel, W2SN, Lake Ave., Helmetta, N. J.
- W3 — Maurice Downs, W3WU, 1311 Sheridan St., N. W., Washington, D. C.
- W4 — G. W. Hoke, W4DYB, 328 Mell Ave., N. E., Atlanta, Ga.
- W5 — E. H. Treadaway, W5DKR, 2749 Myrtle St., New Orleans, La.
- W6 — Horace Greer, W6TI, 414 Fairmount Ave., Oakland, Calif.
- W7 — Frank E. Pratt, W7DXZ, 5023 So. Ferry St., Tacoma, Wash.
- W8 — F. W. Allen, W8GER, 324 Richmond Ave., Dayton, Ohio.
- W9 — Roy W. McCarty, W9KA, 11 South Michigan Ave., Villa Park, Ill.

(Continued on page 88)

# B.C.I. and the Amateur

## Some Do's and Don'ts for the B.C. Interference Problem

BY L. C. WALLER,\* W2BRO

THE theme song of this story should be, "Ignorance is the greatest enemy of peace." The writer suggests that this axiom be added to the amateur's list of useful proverbs.

Although a recent issue of *QST* carried one of the "Our Hero" problems pertaining to broadcast interference, that is not what furnished the inspiration for this story. The inspiration was supplied by the fact that W2BRO recently installed a 250-watt 10- and 20-meter 'phone station in a 45-family four-story apartment building with instructive, if not pleasant, results. The affinity of some broadcast receivers for short-wave 'phone signals is amazing.

Of course, no ham objects to an occasional case of trouble with B.C.I. That is just another technical problem, and is normally to be expected, even though the transmitter is perfectly designed, adjusted, and operated. But in the light of recent experience at W2BRO the toughest case of B.C.I. imaginable is a mere trifle compared to a tough B.C.L. In the opinion of the writer, we hams need to perfect a suitable method of attack on the latter problem far more than we need information on the mechanics of B.C.I. elimination—although we can always do with more of that, too.

In view of the foregoing considerations, the recent experiences at W2BRO have resulted in the evolution of a suggested plan of procedure which is believed to have considerable merit. While the B.C.I. problem, *per se*, is purely technical, the B.C.L. problem is almost purely psychological. In Fig. 1 is shown a new type of "characteristics curve," which is based entirely on personal experience. It is practically self explanatory. At the beginning, the curve naturally starts at 100 per cent (point A) and tapers off very gradually at first. After about eight days the slope increases more rapidly for a time. Points B and C, between the third and fifth weeks, again slope more sharply downward. This part of the curve may be defined as the "boiling point" section. That is, if the average B.C.L. has had his pet programs smeared for three consecutive weeks, he most assuredly will have reached the boiling point. Therefore, if the amateur does not take suitable action until the B.C.L.'s curve drops to some place between B and C, he stands roughly a 50-50 chance of securing some positive cooperation, or a negative amount. The conclusion is self-evident—do not allow point B, or any lower point, to be reached if it is physically possi-

ble to prevent it. The section CD pretty definitely corresponds to complaints put through the F.C.C., and to a greatly reduced chance of securing reasonable cooperation. Of course, the F.C.C.'s form letter to the B.C.L.'s tends to put most (but not all) of them back up on the curve to a point somewhere between 50 per cent and point A. However, there is no good reason that any amateur should let the B.C.L. go until this backing-up action is required. The specific reasons against it are excellent: (1) It means more work and trouble for the amateur. (2) It is not

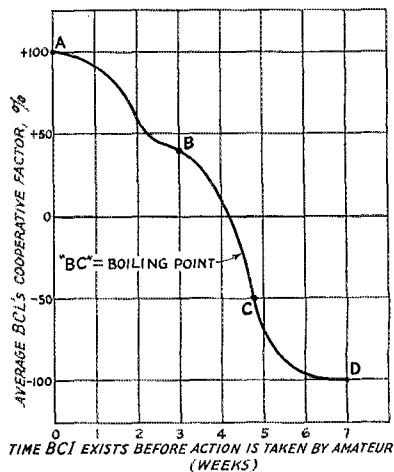

fair to the B.C.L. (3) It means more work for the F.C.C. (4) And most important, it does not help to convince the general public that amateur radio is a service which exists by reason of public welfare and necessity.

The plan evolved from these considerations may be summarized as follows:

(1) When you move into a new location, first put your transmitter into operation in full compliance with all rules and regulations, and then operate it (on all of the bands you contemplate using, if possible) for several days, at various hours.

(2) Do not try to keep your identity and location a deep secret from the neighboring B.C.L.'s. Instead, actually go around and solicit B.C.L. complaints in the immediate vicinity of the station, and explain the whole story in the most friendly way possible, even at the expense of lost operating and personal time.

(3) Offer to eliminate the interference and then

\* 732 Elm St., Arlington, N. J.

do so promptly (not a week later)—but do not use the expression, “I will *fix* your radio for you.” Some B.C.L.’s have modern, expensive sets, and the word “fix” immediately conjures up in their mind a mental picture of a lad with a saw, a hammer, a screw-driver, and a crow-bar tearing up their nice radio and possibly ruining it. Quickly explain that the radio itself does not, in the vast majority of cases, have to be touched; that the installation of an r.f. choke, low-pass filter, or a wave-trap is made in the antenna lead-in circuit, and does not in any way harm the receiver or the standard programs received.

(4) When you are invited in to the B.C.L.’s home, be sure that you are presenting the best possible personal appearance—it will help you to make a good first impression and will make the job easier. Do not barge (that well describes it) immediately over to the radio set and start removing vases, electric clocks (the writer dropped one once), books, etc., with only a curt word or two to the B.C.L. He gets the feeling that you are not a gentleman and that he is being ridden over rough-shod; the fact that you are in a hurry to cure the interference is no excuse, from his point of view. Stop a moment and exchange a few commonplace pleasantries. Tell him you are very sorry he has had B.C.I., but that it is usually a very simple thing to eliminate (not fix). Ask him to move any object that needs moving, or at least ask his permission to move it yourself. Be certain to explain, after the trouble is apparently eliminated, that a change in your antenna, power, frequency, or type of emission may cause B.C.I. to recur; and that if it does, he is to notify you at once, so that further steps may be taken promptly. If you do not do this, and fail to stress the point, he will in all probability get the idea that you do not know how to cure the trouble at all; this blocks further cooperation. And, worse than all other dangers, he may tell other B.C.L.’s whom you have not yet interviewed that you tried to fix his set but did not succeed. If this happens, just try and get cooperation from that other B.C.L.! His “coop factor” will drop like the last stock the writer bought—and that’s sumpin’.

(5) If you have a flock of cases to work on, explain this in a nice way, and point out that it is a rather costly proposition for you; and that if they would be willing to pay the very small cost of the actual gadgets required, it would seem to be a fair arrangement all around and a big help to you. In most cases, nice people will do this gladly and without question. If they object on “the principle of the thing” (i.e., *you* are causing *me* the trouble, so why should I pay you to eliminate it?), try and get them to put themselves in your position. If they cannot or will not do this, do not press the point any further; just smile pleasantly and say, “All right, then, I’ll put in the gadgets on an indefinite loan basis, because I really don’t want you to be interfered with on account of my

hobby.” In many cases, a pleasant capitulation of this kind will win them over, in the end. They may feel just a little bit ashamed of themselves. The Radio Law or the F.C.C. do not demand anyone in particular to pay for the gadgets. However, in stubborn cases, the amateur can well afford to give in, graciously. After all, the stubborn cases will be in the minority if rule No. 2 is carefully observed.

(6) If you run into a really antique set that absolutely refuses to give up its affinity for your short-wave signal, regardless of the treatment, then simply explain the facts to the B.C.L.; tell him that receivers of slightly more modern design than his do not give this trouble, and there just isn’t anything further you can do for him. Do not bluntly say that his set is no good, of rotten design, an antique, etc. He will get the idea if you put it in a more tactful way, and may decide that he does need a better receiver after all. If he intimates as much in any way, be quick to offer to help get a good one. You know what to look for, in a given case, and you should be sure that he realizes he has some expert advice handy, free of charge.

(7) If a B.C.L. is willing to cooperate fully, and you have a bit of trouble in determining the exact treatment necessary, ask him if he will let you take the receiver to your station to locate the cause of the r.f. pick-up (*not* to fix it). Point out that you have meters and other test equipment at home (mention an oscillograph if you have one, for the psychological effect), and that by taking the set home you can do a bang-up job of eliminating the interference. If you can eliminate it at that close range, obviously it will be perfect in its normal location—he can see that.

(8) If some B.C.L. has suffered interference for a considerable time, in spite of Rule No. 2, he may be at the “boiling point” by the time you get to him (that is why Rule No. 2 is of paramount importance). In this case, you will need all the tact and diplomacy at your command, and then some. If he shouts at you and says nasty things, take it quietly and wait until he cools off. Put yourself in his shoes, and think how many of his pet programs have been utterly smeared. Sympathize with him 100 per cent. Tell him that it is a darned shame, that you know exactly how he feels, and that you don’t blame him one bit for being upset (not “angry,” or “nasty,” etc.). Tell him about Rule No. 2, and that it was entirely unintentional on your part that he was overlooked in the original survey. In connection with this possibility, it might be a good plan occasionally to announce over the air (if you have a ‘phone transmitter) something like this: “Attention all broadcast listeners (repeat this several times). If anyone’s radio program is being interfered with, please notify at once ‘Mr. John Doe,’ located at No. 000 ‘Doe’ St., Podunk, N. J., or

(Continued on page 88)

# HOW WOULD YOU DO IT?



## AUTOMATIC METHODS OF MAINTAINING INPUT TO FINAL AMPLIFIER AT ESSENTIALLY CONSTANT VALUES

**I**N PROBLEM No. 23, set forth in *QST* for December, Our Hero asked for suggestions on methods of automatically maintaining the input to his final amplifier essentially constant at some desired value, even though the loading or tuning of the final amplifier might vary within reasonable limits. In certain contests, a multiplier bonus is given to those operators who limit the power input to the final amplifier to some specified value. Our Hero, being a conscientious individual, was in search of some scheme which would insure that the input to the final would not exceed the specified limit even though he tuned the transmitter hastily.

Three practical solutions were submitted. Several contestants suggested the simple expedient of using a resistance in the plate-voltage supply lead to the final amplifier which will have a ballasting effect over a fairly wide range of plate-current values. This scheme, shown at A, Fig. 1, should be quite satisfactory in cases where the power limit may be obtained at about half the normal plate voltage or where a higher-than-normal plate-voltage supply is available. As an example, an input of 100 ma. at 1000 volts is taken as normal for a limit of 100 watts. The effective resistance of the tube is, therefore, 10,000 ohms. If a 5000-ohm series resistance is used, the voltage

drop through the resistance at 100 ma. will be 500 volts and, to maintain 1000 volts at the plate of the tube, a 1500-volt supply will be required. If the plate current is changed by variation in loading or tuning, the effects will be those shown in the following table.

Plate Ma.	R Drop	Effective Plate Voltage	Amplifier Input
70	350	1150	80.5
80	400	1100	88
90	450	1050	95
100	500	1000	100
110	550	950	104
120	600	900	108
130	650	850	110
140	700	800	112

If the series resistance is changed to 20,000 ohms, the drop at 100 ma. will be 2000 volts and a 3000-volt supply will be required. The difference in results may be determined from the following tabulation.

Plate Ma.	R Drop	Effective Plate Voltage	Amplifier Input
70	1400	1600	112
80	1600	1400	111
90	1800	1200	108
100	2000	1000	100
110	2200	800	88
120	2400	600	72
130	2600	400	52
140	2800	200	28

If, however, the resistance is made equal to the effective plate resistance of the tube (10,000 ohms), the drop at 100 ma. will be 1000 volts, a 2000-volt plate supply will be required and the effects are as follows:

Plate Ma.	R Drop	Effective Plate Voltage	Amplifier Input
70	700	1300	91
80	800	1200	96
90	900	1100	99
100	1000	1000	100
110	1100	900	99
120	1200	800	96
130	1300	700	91
140	1400	600	84

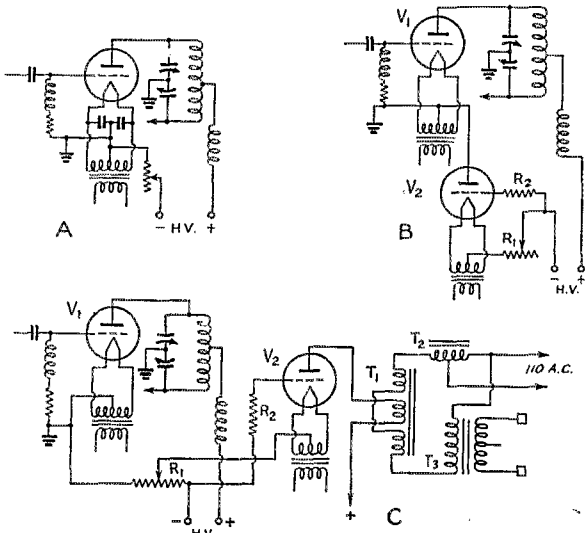

Fig. 1—A—Series-resistance ballast. B—Vacuum-tube regulator. C—System using variable flux regulator. See text for details.

The interesting part of this tabulation is that not only is the variation from the 100-watt limit least with the resistance equal to the effective tube resistance, but also that under no circumstances will the input exceed the specified limit. This assumes, of course, perfect power-supply voltage regulation and sufficient excitation to maintain Class C operation. Poor power-supply regulation will itself cause a certain degree of compensation, the output voltage dropping with an increase in load current. The first tabulation shows that a lower value of series resistance causes a drop in input with a drop in plate current. Therefore, in practical application, a value of series resistance somewhat less than the effective

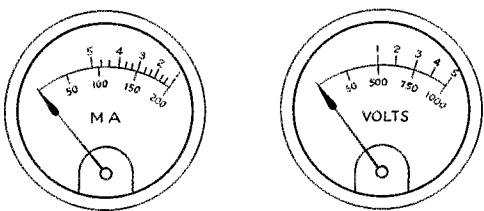

Fig. 2 — Meter calibration for use with manual control.

plate resistance will give the best results. An adjustable resistance with a maximum equal to the effective tube plate resistance could be used adjusting it experimentally to the best value for the power-supply characteristics.

To determine whether this system could be used with the equipment available, divide the highest available plate voltage by two; divide the power limit desired by this voltage to determine the required plate current and from these values of operating plate voltage and plate current, determine if a suitable tube or combination of tubes is available. The value of series resistance to be used will be equal to the reduced plate voltage divided by the plate current. As an example, if a 1500-volt plate supply is available and the power limit is 100 watts, the operating plate voltage will be 1500 divided by two or 750 volts; the maximum plate current will be equal to 100 divided by 750 or 0.133 amperes, and the series resistance to be used will be 750 divided by 0.133 or 5600 ohms.

A second scheme proposed by several is shown at B. Here a triode, such as a 45 or 2A3 and resistor are connected in series with the high-voltage d.c. line. The grid of the triode is connected back to the negative high-voltage end of the resistance so that plate-current flow through the resistance will develop a bias which is applied to the grid of the control tube. Since any change in the plate current of the final amplifier will cause a change in bias to the control-tube grid, and since this change operates to increase the resistance of the control tube whenever the final-amplifier plate

#### PROBLEM NO. 25

With the approach of Spring, Our Hero is giving thought to the problem of providing adequate protection against damage by electrical storms. He knows that an antenna system may be a hazard or a protection, depending upon the manner in which it is installed. He would like to have some suggestions on simple, yet adequate methods of providing protection against lightning.

current tends to increase, or vice versa, the control tube will keep the input to the final amplifier at an essentially constant input. The control tube must be capable of handling the maximum final-amplifier plate current to be expected. Tubes may be connected in parallel in the control position, if necessary. This system should cause less voltage drop than the resistor method and it is quite probable that the input will be held within closer limits when correctly adjusted since the control tube acts as a variable resistance.

W9YOX suggested three different methods which may be used. One of those which has interesting possibilities is shown at C. Here we have  $V_1$ , the tube to which the control is applied,  $V_2$  the control tube,  $T_1$  the regulating transformer,  $T_3$  the plate transformer whose primary is fed through  $T_1$ , and  $T_2$  an auto transformer which compensates for the voltage drop through the windings of  $T_1$ .  $R_1$  is a bias resistor and is tapped also to provide bias for  $V_2$  while  $R_2$  is a decoupling resistor.

The tap on  $R_1$  is the control adjustment and is adjusted so that  $V_1$  is drawing the desired current at the desired voltage. With the plate voltage constant, a change in plate current should cause a change in the voltage drop across  $R_1$  and, therefore, the bias of  $V_2$ . This will cause an opposite change in the plate current of  $V_2$  and also in the voltage across that part of  $R_1$  which is common to  $V_1$  and  $V_2$ , but with  $V_1$  operating Class C, it will have very little effect on  $V_1$ . However, the current change in the control coil of  $T_1$  will cause a change in the impedance of the a.c. coils and, as they are in series with the primary of the plate transformer  $T_3$ , there will be a change in the voltage applied to the plate of  $V_1$  which will be opposite to the change in plate current. As a change in the plate voltage of  $V_1$  will cause a corresponding change in its plate current, and as this change in plate current causes an opposite change in the plate voltage, the voltage change will be limited by the plate characteristics of  $V_1$ . As the plate characteristics of  $V_1$  vary with excitation and plate loading, the plate voltage will also vary with excitation and loading. Therefore, as the control adjustment is set at the point that will give some definite power input, any change

(Continued on page 66)



# HINTS AND KINKS FOR THE EXPERIMENTER

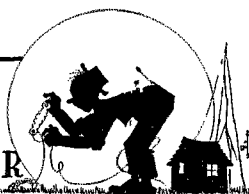

## PUTTING THE ANTENNA BACK ON THE POLE

IF AN antenna halyard breaks, or if the pulley fastening breaks, the unfortunate ham is usually confronted with a big problem. At VE5DG, with the ground frozen and all the rigging fallen to the ground, prospects looked none too pleasant to the operator upon his return after a long absence. The poles were too tall and slender to be climbed, and the condition of the ground was added to the usual obstacles against taking down the poles. Suggestions from sympathizing friends ranged from kites to monkeys trained for such jobs, but none of these was considered practical.

After much searching, a method for replacement of the rigging was found; and with the necessary materials gathered together at a pole, less than twenty minutes were required for the complete operation.

A few 1-inch by 2-inch pieces of wood are used to carry rigging to the top of the pole. A hole is bored through the upper end of the first piece, and through it is passed a short length of stiff wire which is then bent to form a loose circle about the lower portion of the pole. Three hooks bent from soft copper wire and suspended from this hoop

support a slip rope snare in which is placed the new pulley. Short pieces of wire are tied between the stiff wire hoop and a point on the stick a few inches above it, to carry the weight of the slip noose and insure that the hoop remains horizontal throughout the climb to the top of the pole.

This assembly is then pushed up the pole by a member of the crew on a long ladder leaned against the pole, and the top of a second piece is then nailed to the bottom of the first. At this joint is fastened a second loop of wire around the pole, and the operation is repeated.

A sketch of the arrangement of the rigging at the top of the first stick is shown in Fig. 1-A. The completed assembly raised to the top of the pole is diagrammed in Fig. 1-B.

The tackle is sent up the pole one 1-by-2 length, ladder high, at each step in the process. Particular care is exercised to prevent enthusiasm from allowing the loop to be pushed past the top of the pole. As insurance against such a calamity, it is desirable that someone view the closing operations from a point some distance from the bottom of the pole, since it is possible to be deceived by viewing the top of pole from directly beneath.

When the top loop has reached the proper point near the top of the pole, a pull simultaneously applied to the two ends of the rope through the pulley is used to straighten out the soft wire hooks supporting the noose, and to tighten the noose on the top of the pole.

When the pulley is in place at the top of the pole, the sticks are lowered in steps and taken apart, and are then ready for similar use elsewhere.

Although the pole on which this method was used is unguyed, it may readily be applied to guyed systems as well. The top guys provide insurance against overrunning the top of the pole and on a calm day, the intermediate guys may be unfastened from the stakes (if the pole is reasonably rigid) and pulled tight down to the base of the pole while the new rigging is run up.

— William Lowry, VE5DG

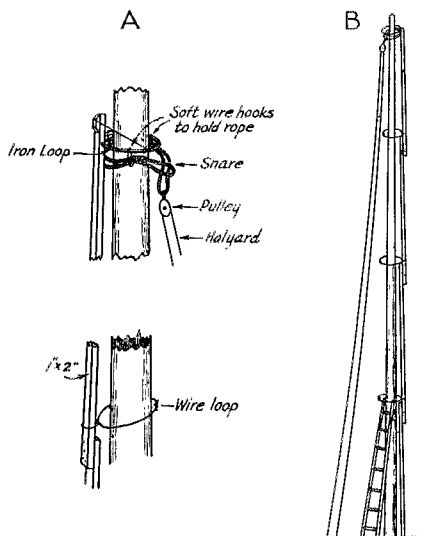

Fig. 1 — Details of the method for replacing antenna pulley and halyard.

## INCORRECT USE OF 110-VOLT LAMPS TO TERMINATE RHOMBS

IN A number of contacts with amateurs using rhombic antennas, dissatisfaction with them in many cases was found to arise from termination in 110-volt lamps. A Mazda lamp cal-



culated by Ohm's law at 330 ohms was used for a series of resistance measurements at different power dissipations, and it was found that the resistance of the unheated filament is approximately 60 ohms, less than one-fifth of the heated value.

Thus, many of the installations making use of lamps have actually presented terminating impedances far from the expected values, and have resulted in improper operation of the systems, probably more often than not dissipating disproportionately large parts of the transmitter output, and leading to standing waves on the rhombic and feeders.

Even though lamps are carefully chosen for proper resistance at the working load, keying the carrier results in rapid change of the terminating resistance, and thus in the radiation of the system. This means that satisfactory use of lamps for termination is almost entirely limited to 'phone operation with output power confined to narrow limits.

— L. F. Sherwood, *HH4AS*

— . . . —

### SIMPLIFIED METER SWITCHING

TO OBTAIN meter economy, provide rapid meter circuit and range shifting, eliminate meter jacks, and avoid necessity of drilling many large holes in front panels, amateurs are now making wide use of meter switching. The installation at W3GKP incorporates a single 0-1 d.c. milliammeter in an arrangement for voltage and current measurements at the turn of a single knob. This simple system should interest fellows with multi-stage transmitters and limited measuring equipment.

The meter, a Weston model 341 with 33 ohms internal resistance, would require shunt resistance of 0.165 ohm for 200 ma. and 0.066 ohm for 500 ma. in the arrangement ordinarily used for milliammeter range multiplication. In view of the expense of such resistors, and of the errors which would be introduced by an ordinary tap switch in series with the shunts, the higher-resistance arrangement of Fig. 2 is considered simpler and less expensive. A combination of series and shunt resistor values may be chosen which will permit use of stock sizes, and thus will make the cost of additional ranges only a few cents each. The resistor values should be held to reasonable limits, however, determined by permissible voltage drop across the milliammeter system.

Since a low-current milliammeter may conveniently be used for measuring electrode volt-

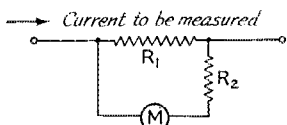
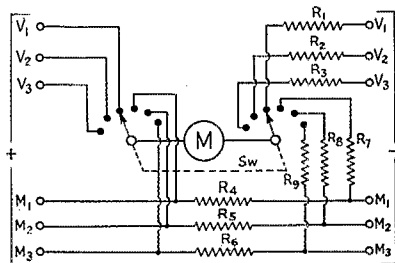

Fig. 2 — Milliammeter multiplier.

Fig. 3 — Complete 3-range voltmeter and 3-range milliammeter which may be used to read on any of six circuits by rotation of switch to proper position. Resistor values are given in the text.



ages, it was decided to incorporate a voltmeter in the switching system. The resulting voltmeter-milliammeter combination circuit is given in Fig. 3. Although there are shown only three voltage and three current ranges, the number which may be provided is limited only by the number of switch contacts and the available resistors.

With this switching arrangement, all of the transmitter circuits involved are left in operating condition with the meter system connected, and the meter may be moved from one circuit to another, voltmeter or milliammeter, without interference to the transmitter operation.

The current shunt resistors,  $R_4$ ,  $R_5$ , and  $R_6$ , are all 10-ohm 1-watt carbon units, except  $R_6$  when used for 500 ma., which then should be a 5-watt wire-wound resistor. The values of voltmeter series resistors,  $R_1$ ,  $R_2$  and  $R_3$ , and the milliammeter series resistors,  $R_7$ ,  $R_8$ , and  $R_9$ , may be obtained from the table below:

Potential Range	Series Resistor
100 volts	0.1 megohm
200 "	0.2 "
500 "	0.5 "
1000 "	1.0 "
Current Range	Series Resistor
25 ma.	200 ohms
50 "	450 "
100 "	1000 "
200 "	2000 "
500 "	5000 "

All of the above may be 1-watt carbon resistors except the one megohm resistor for the one thousand volt range, which should be two 1-watt carbon 0.5-megohm resistors in series, so that not more than 500 volts is placed between the ends of any resistor. Also, for each voltage range above 500, a carbon 1-watt resistor of 5000 ohms should be connected across the pair of switch points used.

One-watt carbon resistors can be obtained in a wide range of even values and have a reasonable constancy when not subjected to overloads. They can be supplied with tolerance of 5 per cent upon request, or the constructor may select accurate resistors by means of a calibrated ohmmeter.

This provides an overall meter accuracy well within 10-per-cent limits, an accuracy quite suitable for most amateur purposes. An exception to this is the measurement of current and voltage of an amplifier of more than 900 watts input.

— William L. Smith, W3GKP-N3GKP

## RECEIVER-OPERATED RELAYS

It is often found desirable in the amateur station to make use of received carriers for relay operation. This may be applied to interstation noise suppression, where relay contacts may be used in series or in shunt with the voice coil of a speaker, or it may be applied to automatic reception of code with a fast-operating relay.

Two simple and thoroughly practical circuit arrangements for carrier-operated relays are shown in Fig. 4.

The circuit shown in A is that of a grid-leak detector, the plate current of which is decreased by reception of a carrier. The armature of the relay is thus held down until a carrier is received, at which time the grid bias of the tube increases, the plate current decreases, and the armature is released. The type of relay shown — single contact closed with no current — may be connected in series with the voice coil of a speaker, to make the latter inoperative during no-carrier periods. This type relay contact is also suitable for keying an automatic recorder or for retransmission of telegraph signals.

$R_1$  is a small d.c. relay designed to operate at approximately 8 milliamperes. Resistor  $R_2$  is adjusted to give sufficient screen voltage to maintain the relay contact open without received carrier.

B is the circuit of a plate detector arrangement which operates in the reverse fashion. The plate current of the tube is normally insufficient to operate the relay, but reception of a carrier results in an increase sufficient to pull down the armature. In this arrangement, resistor  $R_4$ , the bias resistor, is used to control the plate current for proper operation of the relay. If this is used for keying another transmitter, or for other devices requiring a circuit-closing effected by carrier, a relay which makes contact with increased current should be substituted for the type shown.

— James A. Eberhart, W3KKW

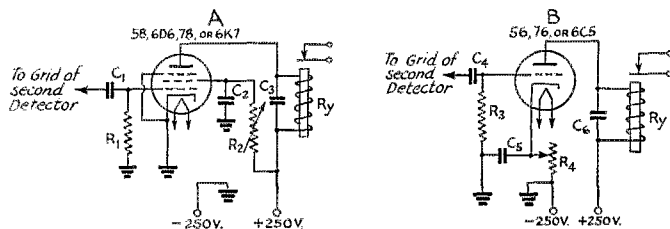

## USE FOR METER BOXES

A MEASURE of protection for meter and for operator results from a simple and ready use of the boxes in which meters are purchased. These boxes are usually provided with cardboard insert with large hole for the body of the meter.

In order to place the meter in immediate use, the meter and the small envelope of mounting screws are first removed from the box. A hole of  $\frac{1}{4}$ - to  $\frac{1}{2}$ -inch diameter is then punched in one side near the bottom, and the meter connecting wires are carried through the side, then through

Fig. 5 — Handy meter mounting.

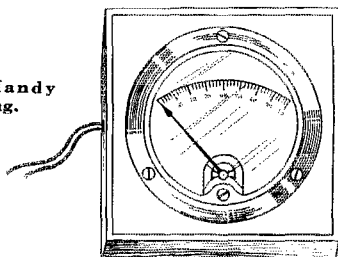

the front of the box, and connected to the meter. The meter is then replaced in the box, and a sharp instrument is used to punch three small holes in the positions of the three meter-mounting holes. The three mounting screws are then pushed through the front of the meter into the holes, in which they should make a firm fit. A sketch of the assembly is shown in Fig. 5. This "boxed" meter is suitable for horizontal or vertical use on the operating table, and danger of having the connections contact metal objects or stray wiring is eliminated.

— George H. Jette, W1LEW, U.S.N.

## Landmark Becomes Ham Emergency Center

(Continued from page 46)

The project is being carried on in conjunction with the general park program of the city, and the local hams give all credit to municipal and WPA officials whose cooperation made it possible. Among the amateurs who have been active in promoting the development, as incorporators of the Manchester Radio Club, are J. Brodie Smith, E. Stuart Davis, Carroll A. Currier, Louis E. Robitaille and Maurice H. Deschenes.

Fig. 4 — Receiver-operated relay arrangements.

- $C_1, C_2$  — 0.01- $\mu$ fd. paper tubular.
- $C_3$  — 0.1- $\mu$ fd. paper tubular.
- $C_4$  — 0.01- $\mu$ fd. paper tubular.
- $C_5, C_6$  — 0.1- $\mu$ fd. paper tubular.
- $R_1$  — 1-megohm 1-watt carbon.
- $R_2$  — 0.5-megohm potentiometer.
- $R_3$  — 0.5-megohm 1-watt carbon.
- $R_4$  — 10,000-ohm potentiometer.

# ★ I. A. R. U. NEWS ★

Devoted to the interests and activities of the

## INTERNATIONAL AMATEUR RADIO UNION

Headquarters Society: THE AMERICAN RADIO RELAY LEAGUE, West Hartford, Conn.

### MEMBER SOCIETIES

American Radio Relay League  
Asociatia Amatorilor Romani de Unde  
Scurte  
Associazione Radiotecnica Italiana  
Canadian Section A.R.R.L.  
Ceskoslovenski Amatéri Ysilaci  
Deutscher Amateur Sende-und-Empfangs  
Dienst  
Eesti Raadio Amatooride Ühing  
Experimental Radio Society of Egypt  
Experimenterende Danske Radioamatorer  
Federation des Emetteurs Belges  
Irish Radio Transmitters Society

日本アマチュア無線聯盟 Japan  
Liga Colombiana de Radio Aficionados  
Liga Mexicana de Radio Experimentadores  
Magyar Rövidhullámú Amatőrök Országos  
Egyesülete  
Nederlandsche Vereeniging voor Interna-  
tionaal Radioamateurisme  
Nederlandsch-Indische Vereeniging Voor  
Internationaal Radioamateurisme  
Newfoundland Amateur Radio Association  
New Zealand Association of Radio Trans-  
mitters  
Norsk Radio Relæ Liga

Polski Zwiasek Krotkofalowcow  
Radio Club de Cuba  
Radio Club Venezolano  
Radio Society of Great Britain  
Rede dos Emissores Portugueses  
Reseau des Emetteurs Français  
Reseau Luxembourgeois des Ama-  
teurs d'Ondes Courtes  
South African Radio Relay League  
Suomen Radioamatööriitto r.y.  
Sveriges Sandareamatörer  
Unión de Radioemisores Españoles  
Union Schweiz Kurzwellen Amateure  
Wireless Institute of Australia

### SOUTH AFRICA

WITH the new provisions in international radio introduced at Cairo that make it permissible for countries outside the Americas to allow broadcasting in 7200-7300 kc., there has been some conjecture in amateur circles as to what conditions will be like when the high end of 40 becomes a propaganda-broadcast haven. We can't tell you that, but we can tell you what G. Ross Kent, ZS6L, vice-chairman of Council of the S.A.R.R.L., says will happen in South Africa. From his letter: "... we approached our Postmaster General . . . and we obtained his assurance that broadcast stations will not be allowed to operate on the 7200 to 7300 kc. portion of our band insofar as this country is concerned."

Mr. Kent also included with his letter a copy of the new South African regulations. They have some interesting points and, if you'll bear with us, we'll make some rambling comment on them.

They have log-book requirements quite similar to those in the United States, requiring the logging of all essential information.

Regarding antennas, "the aerial system shall conform to any by-laws laid down by Municipal or other local government bodies." Direct coupling is forbidden except where matched impedance coupling is used, and "the coupling shall be loose in order to prevent the emission of double waves."

Every licensee must own a frequency meter or monitor capable of accurately measuring the frequency of transmission, and this meter must be accurately calibrated to within 0.5 per cent.

All of the Cairo bands are available for c.w., and 'phone is allowed in 1715-2000 kc., 3650-3900 kc., 14,150-14,250 kc., 28,000-30,000 kc. and 56,000-60,000 kc., as well as in 1½-meter and

1¼-meter assignments duplicating those in the U. S. Music transmission is allowed for test purposes, not to exceed a period of three minutes, followed by complete cessation of music transmission for at least five minutes. An amateur is not allowed to use telephony until he has been actively engaged on c.w. for at least twelve months. Duplex telephony is limited to half an hour in any two hours.

Their regulations concerning d.c. power supply, harmonic and spurious radiation, keying transients and percentage of modulation are quite similar to ours. Further, it is stated in the regulations that an amateur station shall "... be equipped with an efficient transmitter, a selective receiver and a monitor or wave-meter."

The initial annual license entitles the holder to use a maximum input of 50 watts and radiotelegraphy. The second annual license allows him to use 50 watts input and c.w. and 'phone, and the third and any subsequent license entitles him to 100 watts and c.w. and 'phone. In every case where more than 50 watts of power is used the oscillator shall be crystal-controlled or electron-coupled. Portable transmitters may use only one-fourth the power permitted the home station. Portable operation, when authorized, is allowed within the license area under the regular call and, after receiving written permission from the Postmaster General, portable operation is allowed in any license area under the regular call sign followed by the "break sign," the letter P, and the district number.

Every applicant for renewal of a license must satisfy the Postmaster General that the station has been reasonably active during the preceding year or in the event of inactivity furnish good reasons therefor. Unless the amateur station has been inspected by a duly authorized officer, the

licensee must forward with his renewal application his station log book covering the past year's activities.

As in most British countries, communications "... must be limited to messages relating to the experiments and to remarks of a personal character for which, by reason of their unimportance, recourse to the public telegraph service would be out of the question." Communication must be in plain language, which in Africa means Afrikaans, English or French, or in the Q code.

The most marked difference in the regs, at least to us, is the portion governing procedure. For example, a call or CQ is not to be called more than five times before signing, and this is not to be repeated more than three times. (What a blow that would be to some of the CQ-chumps in the U. S.!) The letter K follows both calls and CQ's. Provisions are included for 'phone procedure, and when calling on 'phone the called station is named twice and then the calling station is named twice, repeating for as long as thought necessary to raise the station. Differentiation is made between domestic and "DX" procedure; "CQ DX" may be called ten times on 'phone before signing (not more than ten times), all to be repeated not more than three times.

Apparently just anyone can't speak over the microphone of an amateur station. The regs read: "A British subject, who has proved to the Postmaster General his ability to transmit and receive Morse signals at the regulation speed of twelve words a minute, or who is a member of an amateur radio organization recognized by the Postmaster General, may be allowed by the licensee to operate the key or microphone for periods of short duration under the supervision of a licensed amateur with the object of instructing such person in the operation of a transmitter." However, this does allow an unlicensed person to get actual code practice on the air before he has obtained his license.

The S.A.R.R.L. enjoys excellent contact and relations with the Postmaster General and his staff. Most of the revised and new regulations are the result of a two-days' joint meeting of the government representatives and the S.A.R.R.L. council.

-----

#### HERE AND THERE

*Sweden:* Interest in amateur radio is steadily increasing, and the S.S.A. is growing stronger. Newly-elected and re-elected officers include Erik Lofgren, president; Costa Siljeholm, SM5SI, vice-president; Arne Lindberg, SM5VR, secretary, and Hans Eliaeson, SM6WL, editor of *QTC* . . . . *Switzerland:* There are now 101 licensed amateurs here, with 92 of them active. The USKA is working towards more c.w. and less 'phone, in view of the extremely bad conditions in Europe . . . . *Greece:* Amateurs have been re-

quested to "pipe down" until the new regulations are formulated . . . . *France:* A very strong editorial in *Radio-REF* by President G. Barba, F8LA, inaugurates a "c.w. campaign" in an effort to clean up the unfortunate situation and intolerable conditions brought about in France by allowing "no-code" licenses for 'phone operation. The REF intends to clean up their bands so that the future of amateur radio will have a better chance . . . . *England:* The Senior B.E.R.U. Contest will run from February 4 to February 7, and the low-power (Junior) Contest will run February 9th to February 12th. The Contest, you know, is open only to British subjects living within the British Empire and British Mandated Territory who are members of the R.S.G.B. or a British Empire society, so don't waste the time of the entrants by calling them during the period of the Contest.

### How Would You Do It?

(Continued from page 61)

in excitation or loading will cause the plate voltage to change to a value that will give approximately the same power input.

Various types of manual control of input were suggested by some but, of course, these do not meet the specified requirement of automatic control. One idea which seems worthy of mention, however was submitted by W8OMM. He suggests the use of a variable autotransformer, such as a G.R. Variac feeding the primary of the plate transformer for regulating the power input to the desired point. A plate milliammeter and voltmeter are used to indicate power input to the final amplifier. To eliminate the necessity for calculating power input from the current and voltage readings, he suggests furnishing each of the meters with an auxiliary calibration as shown in Fig. 2. Voltage and current scales are given similar numbers at points where the product of the two gives the desired input. For instance, for an input of 100 watts, the 500-volt point on the voltmeter and the 200-ma. point on the milliammeter will be labelled 1; the 600-volt point and the 166-ma. point will be labelled 2; the 700-volt point and the 142-ma. point will be labelled 3. Equal numbers will also be marked on the scales at 800 v., 125 ma.; 900 v., 111 ma.; and 1000 v., 100 ma. Then it is necessary only to adjust the autotransformer until the meters have equal readings according to the new scales to set the input to the desired 100 watts.

#### Prizes

First Prize: C. A. Peckham, W9YOX.

Second Prize: Philip Reich, W2HUG.

We wish also to thank the following for their contributions: W1JBJ, 2LOM, 3EEI, 4DNA, 4EMF, 5EQP, 7BHE, 7FGQ, 8BYU, 9EHD, 9TFS, G2IS, GM6IZ, K. Brown and A. Faulkner.



## CORRESPONDENCE FROM MEMBERS

The Publishers of *QST* assume no responsibility for statements made herein by correspondents.

### **SWEEPSTAKES SUMMARY**

2815 34th St., Astoria, L. I., N. Y.

Editor, *QST*:

Thank heaven it's over! It's been nigh on fifteen years since I entered a contest (if my memory doesn't fail me it was the trans-cons) but, boy, what a kick I got out of the tough competition the young squirts gave me!

Sleepless days and sleepless nights . . . home QRM . . . constant CQ's by the XYL . . . baby trouble . . . and a host of other complications — but at the end I was still there, if just a bit groggy.

For hours after the darn thing was over dots and dashes continued to emanate from doors . . . faucets . . . coffee cups . . . pillows . . . what not. Some fun!

Please rush me the necessary forms to accommodate upwards of 400 contacts with 67 or more sections, . . .

— Gene Turney, W2APT

**EDITOR'S NOTE.** — Remember the old Crystaloi detector and those Turney spiderwebs? Well, it seems here's one old-timer who hasn't lost his touch. It is a remarkable commentary on amateur radio that a man of W2APT's background and experience should still get such a kick out of the game after all these years.

### **INSIDE-OUT B.C.L.s**

S/S *Greathope*, Copenhagen, Denmark  
Editor, *QST*:

What are the best things in amateur radio? The spirit that dares to try what has never been done before; the spirit that reaches over seas and mountains to distant lands; the quiver of excitement we get from our first QSO; the mature feeling of accomplishment we get later from operating a more complex outfit, conscious of all the little niceties of adjustment and all the little courtesies of operating; the happy thoughtful silence that sometimes falls unbidden on the congenial group in a shack late at night when the last SK has been sent — these things cannot be wrapped in cellophane and sold for so much a dozen.

What are the worst things in our hobby? Stereotyped QSO's? The QSL card situation? Thoughtless, inconsiderate operating? Petty

squabbling within our ranks? We have always put up with these things, but I think the most discouraging is that apparently about a third of our number at the present day are not amateurs at all, but merely B.C.L.'s turned inside out. What about the man with more money than sense who buys a high-power commercially-made station and uses it to broadcast drunken parties, who sneers at the clumsy efforts of the beginner next door when he himself has never made the simplest piece of apparatus and sends his own back to the factory when anything goes wrong with it?

For years there have appeared in our Correspondence columns criticisms of the trend towards manufactured apparatus, not components but ready-made units for the "amateur amateur" whose only contribution to the design of his station is the placement of it in the living room. Let us by all means take advantage fully of the splendid array of new tubes and components made available by commercial research. It is not this that spoils the amateur game; it is the availability of "amateur" transmitters and receivers, now sold not only by the old firms from whom we have been buying parts for so long, but by others who suddenly realize the existence of a new lucrative field. Some of these jobs (not all) are well-engineered units. But if the A.R.R.L. is still an amateur organization it should do something to discourage this particular type of commercial expansion. Already it is leading to agitation for the removal of code requirements for five metres; this can only be to enlarge the market for manufactured transceivers. None of us wants to kill legitimate business when it is legitimate, but if the manufacture and sale of complete units continues at the present rate these "amateur amateurs" will grow in number until they can outvote the rest of us in our own organization, the A.R.R.L. Then good-bye, code test; good-bye, operating efficiency; good-bye, emergency organization; good-bye our spirit of research, progress, and brotherhood. Ten million bored stiffs will sit in front of ten million identical rigs; "Amateur Radio" will be a bigger business than ever before, but its soul will be dead.

My proposal is that *QST* should ban advertisements of complete units from its pages as a measure of discouragement. The loss of revenue would only be giving up something it ought never to have had. If any big firm threatens to withdraw

(Continued on page 86)



# OPERATING NEWS



F. E. HANDY, W1BDI, Communications Mgr.

E. L. BATTEY, W1UE, Asst. Communications Mgr.

**Sportsmanship.** These individuals deserve our whole-hearted condemnation whenever and wherever we find them:

The ham with the wabby chirpy e.c.o. who inconsiderately parks *right* on top of the station we're working.

The chap who gets caught off frequency and then squawks about injustice and tries to produce alibis.

The careless guy with harmonics on Airways and A.T. and T. frequencies who destroys what A.R.R.L. emergency corps men build up — public esteem.

The message pusher who has too much false pride to ask for needed fills, garbles deliveries, or is so unreliable he delays or loses TFC for which he has accepted responsibility!

The confirmed testers who seldom sign, but bust up good QSOs for their betters.

The buzzards that never QSL under any circumstances.

The man with the tough note with whiskers who uses a big slice of band.

The voice station that consistently overmodulates to bust thru.

The radiotelephone operator who so far forgets the proprieties as to allow transmission of any doubtful character to enter the public domain (and cause reflections on the amateur service by his action).

The fellow with BCL QRM who lords it over his neighbor, talks him down, and creates an enemy-to-the-last for the whole amateur service.

The fellow who goes in for awards in operating or activities and who then doesn't want to abide by the rules that govern everybody else.

The DXer after tin-god fame, that cheats to get Century Club cards by going *out of band* for short periods to grab countries.

Sportsmanship is an exhibition of traits characteristic of sportsmen. A sportsman is one reputed to be "fair" and "generous," a good loser, as well as a graceful winner.

The good amateur is engaged in a hobby that compares with none other. In his every act he has an opportunity to show himself a good sportsman — or otherwise.

By repute we know a few of the fraternity that have records to their credit who are ace high with everybody, good sportsmen. We know others who are on the climb to fame, who have apparently become so eager and grasping for the *symbols* of achievement, that they have (in a selfish spirit) lost their sense of responsibility, their spirit of comradeship, their considerate regard for others with whom they associate on the air. Instead of a fraternal spirit these have an individual spirit, one of assumed (not actual) superiority, an attitude of studied condescension toward others. These are not sportsmen. By their little deeds,

their small talk and their written attitudes you may know them.

Some of these amateurs who do not meet up to general A.R.R.L. standards are positively hurting the amateur game as well as cheapening themselves. The fellow who sneaks off frequency even by one kilocycle to "chisel" some DX only makes himself despicable. He is *always* heard. Sometimes he collects a well justified pink slip, from the F.C.C., but he always gets logged by his DX brethren . . . and rather than getting credited for being "smart" he becomes known and despised, both secretly and openly, and *pity*ed by those of us that have more real sporting blood!

The little things of life often are tremendously significant. It is more to be desired that we have a sound character as an amateur among amateurs, than to strive for outward symbols if gained by taking unsporting and unfair advantages! The League offers a number of awards and encouragements for amateur accomplishment. When honestly won it certainly is a matter of pride to hold these evidences. On the other hand, how shallow must be the symbol for an amateur who knows of any deviations of his from the unwritten code of ethics and sportsmanship that occurred on the way to the result!

The real sportsman and amateur rises above that which is petty and small. He values the prestige of awards, and the responsibility and code of ethics that is emphasized by official appointments. He does not stoop to any unfair methods or grasping practices to achieve his awards. He is law abiding, and follows the rules of his competitions and his Amateur Code. The real sportsman is a responsible citizen. In the everyday world he does not set fires, or damage property of others. In the amateur world he (similarly) does not cause undue interference when he can withhold his hand (and signal). Above all, he is on his toes to cooperate to the utmost with his neighboring listeners — and as well as constituting a responsible ambassador to the whole fraternity while so engaged, he checks up his transmitter for spurious radiations, adjusting for minimum harmonics to avoid interference which might cause damage to important government and public-service transmissions — and thereby serious injury to the whole amateur-radio cause! As he operates he tries to be moderate and considerate of others, a sportsman and a useful amateur citizen.

Irresponsibility of the few unfortunately always reflects against the many. Within our bands, there is a growing spirit of intolerance toward the individuals who are inconsiderate, and value their transmitting privilege lightly. The sporting instincts within the brotherhood have in recent years been strongly aroused against those who because of carelessness or intent were logged off frequency in any major activities. It is a correct tendency, the growth of this kind of intolerance. The crummy signal, the inconsiderate tester, the fellow who has no real generosity or helpful spirit *within* bands, pales to insignificance when we consider the dangers that beset all of us in possible future increases in restrictions, and possible loss of privileges from careless, inconsiderate, or wanton amateur operating that has an effect *outside* our bands and with neighbors and citizens *outside* our amateur circle.

The object of this little review of some of our less handsome operating furniture is to focus a little light on the obscure practices that ought to be speedily driven out of amateur radio by outraged amateur opinion in direct contact with these practices.

When you hear a bad note *tell* the operator about it, and that you don't think much of it! Live up to a high set of operating standards and look frankly to other amateurs to do the same! When you hear a ham sneak out of the band for a QSO and hop back in, tell him about it. Warn him. Make your low opinion of this sort of work clear, and make it clear that your friends and his are going to know about his unsporting work, too! Use your influence on the side of perpetuating amateur radio. Be utterly intolerant of the transmission on the air of dubious "parties," suggestive allusions or stories. As many amateurs as possible should instantly "nail" such things and "ride offenders unmercifully." Also, any off-frequency operation is potentially dangerous, likely to cause interference, and trespass on other people's frequencies and rights. Call on amateurs out of the band limits to check up and move in! Likewise, amateurs with general coverage coils can do the fraternity a service by checking up on the harmonic shadows of bands at 21 to 21.9 Mc., 7.3-8 Mc., 10.5-12 Mc. and the like. Start messages or postal cards to any amateurs heard in such regions asking their immediate cooperation. You will be doing them, and Amateur Radio (which includes yourself) a real service. All the things listed at the start of this dissertation, and which many members write Headquarters about time and again, are subject to remedy by exercise of the proper degree of personal intolerance directed from many sources at the chief offenders. Do *your* part in a better operating program. A more sportsmanlike and enjoyable amateur radio will result for all.

— F. E. H.

## 1.75-Mc. Trans-Ocean Contacts

A SPECIAL "160 meter c.w." test arranged via radio by G6WY and others for January 7th-8th resulted in many W-G contacts. Conditions were excellent and the band was literally teeming with G's. VE1EA worked G5JO, G5RI, G5XH, G2RC, G5QY, G2CF, G6GH, G6HQ and G6MQ; heard G6GM, G6GL, G3AH, G5MY. W1BB worked G5RI, G2PU, G5QY and G6WY. W1AW worked G6WY, G6MK, G2PU and G5QY; heard G5PR, G6GL, G2IZ and G2CF. W1DIZ, with 6 watts input, established contact with G6WY. W1BB and VE1EA each received one report of S9. Reports at both W1BB and W1AW averaged S6. All this was between 11:00 P.M. and about 2:00 A.M. EST, when signals faded out.

With such work as the above being reported the February 1.75-Mc. Trans-Atlantic Tests (see page 90, January QST) are expected to be most successful. Please report all "160 meter" DX contacts or reception to A.R.R.L.

### "Hello CQ"

W9ONI tells of the inquiry received at a local broadcast station (WEBC) regarding the whereabouts of station L-O-C-Q.

## PRIZES FOR BEST ARTICLE

The article by Mr. C. J. Buck, W8LVU\* wins the C.D. article contest prize this month. Each month we print the most interesting and valuable article received marked "for the C.D. contest." Contributions may be on any phase of amateur operating or communication activity (DX, phone, traffic, rag-chewing, clubs, fraternalism, etc.) which adds constructively to amateur organization work. Prize winners may select a 1938 bound *Handbook, QST, Binder* and League Emblem, six logs, eight pads radiogram blanks, DX Map and three pads or any other combination of A.R.R.L. supplies of equivalent value. Try your luck. Send your contribution to-day!

## "Please QRS"

BY C. J. BUCK, W8LVU\*

QUITE a few members of the amateur fraternity have a complex in regards to their receiving ability, and wish the other operators to believe they could copy better if there were no interference. Generally they will give you a report that indicates your signals are readable, but then they tell you that QRM was on you and consequently they did not get a thing that you said. But when you slow down to a bare six or eight words per minute they can receive you solid!

In my estimation, from twenty-five years of Western Union and railroad telegraphy and ham radio experience, it is not a thing to be ashamed of to be a slow receiving operator. I have found that some are natural operators, while to some it is an uphill climb to become a first-class man. It would save time, labor, cost of power used and also the patience of the sending operator if the slow men would shove their pride into the background and ask for a QRS if not able to receive at the speed the operator is sending.

Another thing that has been sticking is the man with a bug, who, wishing to impress some, one that he is a fast operator, sends at speeds that he is unable to copy himself. Then he will run up against some one who can travel along at his keying speed and send back to him at the same rate. In most cases these fellows cannot come anywhere near copying at the speed at which they transmit and the result is generally that they cry "QRM." This may seem a good excuse to cover up poor copying ability, but after a fellow has put in many years in code work he can tell in most cases whether or not it happens to be QRM or vanity.

I would suggest that the fellows concerned use QRS or slow down their bugs. Bugs can be adjusted to send slow or fast. Try to make your key-

\* Hilborn Ave., Tiro, Ohio.

ing readable and not to get into water too deep to waste by sending faster than you can copy.

Articles in *QST* have complained about the misuse of QRZ. The signal QRM is being misused also! A chap who cannot receive as fast as the other fellow is sending while QSO should be so good as to ask for a "slow down." It would make a more enjoyable QSO. Don't cry "Wolf" (QRM)! Any real amateur will QRS when requested and continue the QSO as long as the other fellow. It is no disgrace to request "Please QRS."

The man who sends "QRS" to get his copy neat, solid and *accurate* has the mark of the real operator, and is more to be respected and emulated than his opposite.

## Use New Punctuation Symbols!

**T**HE International Telegraph Regulations, as revised at Cairo, 1938, made certain changes in the International Morse Code as follows:

- (a) The former period sign . . . . . was changed to . - - . -
- (b) The comma sign shall be - - - . -

The Federal Communications Commission states that inasmuch as the International Morse Code now in general use in the radio services, especially in the maritime mobile service, is based upon the code prescribed in the International Telegraph Regulations, it is assumed that the changes referred to will receive universal adoption on and after January 1, 1939, the effective date of the Regulations.

The F.C.C.'s release on this subject, addressed to all radio station licensees in December, would indicate that individuals taking F.C.C. examinations should at once make themselves familiar with the new symbols for their transmitting and receiving tests.

While the Telegraph Regulations have not been ratified by the United States, such a declaration by the F.C.C. indicates the Commission's expectation that amateurs will use the new symbols for punctuation on the air at once and henceforth when punctuation is needed. This announcement indicates that A.R.R.L. practice is modified at once. Our amateur operating does not require the use of much punctuation in normal work. Best practice in message handling, as always, will require that periods and commas required in texts of messages be spelled out completely wherever they appear.



Miss Frances V. Rice, W3AKB, Asst. Section Communications Manager in charge of Emergency Organization, Eastern Pennsylvania; Route Manager; O.R.S.; and Manager of Trunk Line "C" (Maine to Florida). "Fran" is one of the most active YL operators in A.R.R.L. work. In spite of her many duties she always finds time for a good rag-chew, and is an enthusiastic member of the R.C.C.

## BRIEFS

It has been suggested that due to increased carelessness in use of e.c.o.'s, the presence of unnecessary harmonic radiations which are getting some amateurs into difficulty with the Airways and transocean telephone services, and the like that more A.R.R.L. observers should be appointed in each Section at once.

Individuals equipped with accurate frequency measuring equipment who can assist in perpetuating amateur radio by helping their fellow amateurs, through mailing of A.R.R.L. warning notices, direct radio notification of amateurs, etc., are requested to report their equipment and wish to help to A.R.R.L. S.C.M.'s at once. The Section Managers are requested to appoint more properly qualified Official Observers to work on this problem.

## BCL QRM

An Ohio amateur (W8OXV) recently traveled 75 miles to look into a case of interference reported from that distance against his station. It so happened that he found that it was a "nearby" amateur using a similar call. We admire his spirit and conscientious effort that represented amateur radio in a fashion that helped this listener regard amateurs in a different light. It just reminds us to say that the average ham shouldn't kick about the simpler matter of equipping local listeners who run into QRM trouble with a few inexpensive wave-traps to alleviate their difficulty. Each amateur is (in such matters) the ambassador of the whole amateur fraternity.

The most effective approach for any interference case where the BCL's aged receiver of inadequate input selectivity is at fault, is to demonstrate on a well-engineered not-so-new set, that excellent reception with *no interference* is perfectly practical. In most cases a simple wavetrap demonstration will indicate an inexpensive cure possible. Fixing up a few such is provocative of great goodwill and well worth the few pennies invested. The offer to put in such devices in considerable numbers is best accompanied by the suggestion that this is done on an "indefinite loan" basis, and the value may be stated. It is better to suggest a local radio service man or store than to build them for money, since this invites the suspicion that you may be making a profit out of interference, which would cancel the goodwill that is needed.

## N. H. Emergency Mobilization

The first mobilization of amateur radio emergency facilities in New Hampshire was called by S.C.M. Evans, W1BFT, on Sunday, December 4th. Thirty stations (forty operators) in twenty cities and towns reported into the various nets working on 1840, 3600, 3735, 3915 and 7200 kcs. Nine additional operators and seventeen assistants (non-operators) were also reported. Thirteen stations had emergency equipment available for immediate use in eleven cities and towns. Another test is scheduled for the first Sunday in February, when all stations having emergency equipment will be requested to use same. Those participating in the December mobilization included W1DMD AWU APK PFL CME HQS HTO GHT TA KKQ FTJ DUK HXJ LIQ AYH HGV ANS BST ITF AEF CBA KPL IDY ANP IUI KMH KLV FJH AP and JDP. W1DMD, W1APK, W1TA and W1IDY were control stations.

W2DOG's first 1.75-Mc. 'phone QSO was with W1KAT!

Don't miss the "160 Meter W.A.S. Party," to take place on the February 18th-19th week-end. Details will be found elsewhere in this issue. Here's a chance to see just how many states you can cover on "160." It's going to be real sport!

W8PLA worked W1PM one night recently; and next morning he worked K5AM. That's timing 'em!



# F. C. C. Regulations on Emergency Communication

**F**OR the amateur service, the recently enacted Federal Communications Commission regulations give greatly increased assistance, looking to the larger general emergencies necessitating radio communications. The problem of the isolated operator and station in such circumstances has been by no means overlooked. Increased opportunity and responsibility in communications emergencies should be welcomed by amateurs. There is no sounder basis than service contributing to the public welfare for justification of a liberal government position in defense or extension of our allocations. The restrictions militating against casual conversation, testing, or any operation not pertinent to the handling of the emergency situation, in either the 80- or 160-meter bands after the Commission has "declared" an emergency to exist, is to give a fair chance to the operators that have contacted their Emergency Coordinators or otherwise been lined up definitely with the proper local officials and authorities and have a real job to do. There are teeth in the F. C. C.'s regulations. On conviction of a violation of any one of the emergency provisions one may, in addition to the other penalties by the licensing authority, be fined by a court, not more than \$500 for each and every day of a violation.

## WHAT WILL BE EXPECTED OF AMATEURS? NOTE THE PERTINENT REGULATIONS WELL.

"152.54. *Operation in emergencies.*—In the event of widespread emergency conditions affecting domestic communication facilities, the Commission may confer with representatives of the amateur service and others and, if deemed advisable, will declare that a state of general communications emergency exists, designating the licensing area or areas concerned (in general not exceeding 1000 miles from center of the affected area), whereupon it shall be incumbent upon each amateur station in such area or areas to observe the following restrictions for the duration of such emergency:

"(a) No transmissions except those relating to relief work or other emergency service such as amateur nets can afford, shall be made within the 1715-2000 kilocycle or 3500-4000 kilocycle amateur bands. Incidental calling, testing, or working, including casual conversation or remarks not pertinent or necessary to constructive handling of the general situation shall be prohibited.

"(b) The frequencies 1975-2000, 3500-3525, and 3975-4000 kilocycles shall be reserved for emergency calling channels, for initial calls from isolated stations or first calls concerning very important emergency relief matters or arrangements. All stations having occasion to use such channels shall, as quickly as possible, shift to other frequencies for carrying on their communications.

"(c) A 5-minute listening period for the first 5 minutes of each hour shall be observed for initial calls of major importance, both in the designated emergency calling channels and throughout the 1715-2000 and 3500-4000 kilocycle bands. Only stations isolated or engaged in handling official traffic of the highest priority may continue with transmissions in these listening periods, which must be accurately observed. No replies to calls or resumption of routine traffic shall be made in the 5-minute listening period.

"(d) The Commission may designate certain amateur stations to assist in promulgation of its emergency announcement, and for policing the 1715-2000 and 3500-4000 kilocycle bands and warning noncomplying stations noted operating therein. The operators of these observing stations shall report fully the identity of any stations failing, after due notice, to comply with any section of this regulation. Such designated stations will act in an advisory capacity when able to provide information on emergency circuits. Their policing authority is limited to the transmission of information from responsible official sources, and full reports of

(Continued on page 82)

# Brass Pounders' League

(November 16th-December 15th)

Call	Orig.	Del.	Rel.	Extra Del. Credit	Total
W7EBQ	0	0	1562	0	1562
W4PL	17	50	1454	33	1554
W9JTD	386	263	823	30	1502
W7EDU	0	0	1152	0	1152
W3BWT	102	96	710	53	961
W8KWA	26	119	790	0	935
W5BN	575	80	96	96	847
W4TR	15	72	670	40	797
W6IOX	28	20	720	18	786
W5PXX	325	64	184	184	757
W9ZDL	17	21	682	18	738
W9NPL	16	28	656	6	706
W2JHB	56	30	576	28	690
W5FDR	47	126	384	115	672
W3CIZ	34	92	448	90	664
W8QID	69	108	361	68	606
W3GTS	113	60	361	60	594
W3EZ	10	35	503	35	583
W8ISK	7	14	548	13	582
W1INW	45	35	496	0	576
W2CGG	37	44	452	41	574
W3TDD	14	5	550	5	574
W8BTV	9	39	496	23	567
W5CEZ	35	120	364	34	553
W8CMI	6	4	520	2	532
W9OUD	24	36	447	18	525
W5EOE	28	122	362	12	524
W6LLW	30	67	390	34	511
W9BKQ	19	32	452	0	503

## MORE-THAN-ONE-OPERATOR STATIONS

Call	Orig.	Del.	Rel.	Extra Del. Credit	Total
KA1HR	1140	544	878	0	2562
W5OW	192	210	1252	67	1721
W1GOJ	68	75	429	54	824
W9BTV	46	152	479	28	665
W8PHG	71	250	275	0	596
W1AW	84	120	198	114	516

These stations "make" the B.P.L. with total of 500 or over. One hundred deliveries+ Ex. Del. Credits also rate B.P.L. standing. The following one-operator stations make the B.P.L. on deliveries. Deliveries count.

W1KZT, 220	W2GVZ, 178	W6ZX, 125
W1JSM, 245	W6DH, 175	W3EML, 120
W6NLL, 240	W2JZX, 166	W1IHL, 118
W3QP, 226	W5MN, 164	W9TUV, 110
W2OQ, 210	W1KIN, 152	W1TS, 109
W6EJA, 208	W8ECS, 150	W9EDQ, 106
W6ITV, 208	W6CZO, 141	W9QKJ, 99
W7APS, 199	W1JCK, 137	W6MDI, 103
W9ERA, 196	W8FUV, 137	More-than-one-opr.
W6IMI, 192	W1ERE, 133	K5AA, 147

## A.A.R.S.

WLTK (W9KJY) made the B.P.L. on 136 deliveries

## MORE-THAN-ONE-OPERATOR STATIONS

Call	Orig.	Del.	Rel.	Extra Del. Credit	Total
WLM (W3CXL) 162	198	3900	123	4383	
WLN (W2SC) 90	140	625	43	898	

A total of 500 or more, or 100 deliveries Ex. D. Cr. will put you in line for a place in the B.P.L.

## Corrections, Contest Results

With reference to the 1938 Field Day Results (December QST), the call used by the Dells Region Radio Club was W9HHR/9 instead of W9RBI as reported. . . . In the 1938 DX Contest scores W8DPY/2 was erroneously listed as W8DBP/2 and G8PI as G5PI.

W5BN and W5FXX were honored by the New Orleans Association of Commerce for outstanding traffic work. W5BN is the southern terminus of A.R.R.L. Trunk Line "H" (North Dakota to Louisiana) and FXX is his alternate.

"Gerry" Sayre, W2QY (ex-OX2QY/W1OXAB/WAWG), is now residing at Milton, Wis., at the home of his folks. The Milwaukee Radio Amateurs' Club was recently honored with his presence as guest speaker.



# How's DX?



## How:

**E**VER since a certain individual ruthlessly told us there ain't no Santa Claus we've been an old skeptic. But because we know that there are countries where everything isn't smooth sailing, and because a lot of you are interested in OY4C, we're going to quote the message from OY4C to us that was relayed by W3EEW. It sounds pretty sincere.

The text: "Dec. 29th. I ask you to print my following report in QST. I am a well known station to a great number of USA amateurs and others in the whole world. I have worked WAC all USA and VE districts, has USA contact on 14 Mc., 7 Mc., 3.5 Mc., and out very nice. My station is a 60 watts Hartley for all bands antenna 38 mtr Fuchs receiver is OY2 ac. I am very sorry to tell you the following news. It is my duty as a ham to let you know who is OY4C. I do not want to be called a phoney. For I am a foreigner in my country it is impossible to get a license, you all know that a real ham must work and so I took my own license with the call OY4C. What would you do in my case? I believe the same! I tried to get and send QSL via EDR Denmark or direct via the address E. Nissen, Fernis, Faeroes, but in vain without success. My own address I cannot tell you for it would be too dangerous for me, a very bad luck! Believe me hams I am very unhappy in my situation here. I would be very pleased if I could QSL sure. The given QTH with Faeroes is nearly true, more I cannot tell there about. I have worked from about June till December 1938 with the call OY4C. Before my time here I was licensed in my motherland, and I intend to leave my present country very soon to get a license elsewhere. So I know that you understand me and excuse me. OY4C is now QRT for all future. At last I will tell you that I will send you the QSL cards all together to the QSL Bureau of the ARRL direct. I also ask you to take the QSL's for other countries and mediate them. But wait still some months, they shall come sure! I am very unhappy that I can't get your cards but I can't help. I will still tell you that I always get the QST here. I wish all hams good luck and hope euagn in some time under new licensed call. sig OY4C."

And best of luck to you, OM.

## Where:

W8HWE worked ZC2MA (14,300 T9) at 10 one morning, and was told that the QTH is Keeling Island, QSL via the VK Bureau. Keeling is the name sometimes given to the Cocos Islands, so he's probably well worth looking for . . . . W8LZK suggests that if you're worried about ever working Spanish Morocco or the Balearic Islands you go back through your old cards and look for EAR47 and EAR50. Mac and W5DLY give the dope on VQ5FLD (14,035 T9), which is that he's quite legit and cards go to Post Office, Entebbe, Uganda. More Uganda dope is that WIWV worked VQ5AB (14,040 T9) for the VQ5's first W . . . . W7GZN worked FN1C (7100 T9x) at midnight, which makes us very suspicious because that would be only 2 P.M. in French India . . . . The NZART magazine "Break-In" carries a note that Tristan da Cunha has a radio station now: ZOE in the commercial bands and ZD9AB in the ham bands . . . . VK3UM is kind enough to set us straight on the New Guinea and Papua stations. The active ones are in italics: *VK9XX, 9VC, 9DK, 9BW, 9RC, 9DM, 9RW, 9GW, 9AW, 9GM, 9MC, 9WF, 9WL, 4HN* (phone), *4KC, 4KT, 4LF, 4VX, and 4WE*. If you've worried about your card from VK9BW you'll be pleased to know that he is sending them out very soon . . . . Cards for LZ1ID can go care of HB9CE, and you might try those for LZ1AA (14,430 T8) via the same route . . . . W6NHA worked a couple that are honeys if they're legit: AC4XX (14,025 T9), S. Austin, General Delivery, Lanchow, Kansu; and AN9AA (14,400 T7), Box 85, Katmandu, Nepal. Both said to QSL under cover . . . . W6HIP tells us that via SU1WM he

learned that VU7BR (14,340) is at Bahrein Island and on every day at 1430 GMT . . . . ex-W8IGQ suggests that the San Martin Island PK7XX claimed might be the Dutch San Martin near Antigua . . . . PJ4F got into a lot of trouble because so many fellows, hams and SWL's, wrote to him and precipitated on investigation. He only worked W8AFX, W1ZB, W2BMX, W9MVM and W8AU, on 7 Mc., and is now off the air for good . . . . If you've worried about XU4XA's authenticity, don't. W2CMY skeds him and is told that cards are on the way . . . . XU2AW (14,200 T9) looks OK, and gives his address as A. B. Ward, Box 45, Peiping . . . . Wish we were sure about ZM1AP (14,415 T9) worked by W3UVA and W9JDP. He gives his QTH as Upolu, Western Samoa . . . . LX1DY is a phoney . . . . Don't let the call NY3AAN fool you. W2LNN received his card . . . . K7FST (14,230 'phone) planned to operate from East Cape, Siberia, during Feb. 4th and 18th, but the weather may keep him away. It was 35 below and 25 feet of snow when W6OI worked him in late December . . . . The VO1H on 2280 is a phoney . . . . Good bets picked at random: XZ2DY (14,350 T9), U8IB (14,375 T9), UK8IA (14,350 T6), YS2LR (14,410 T9) and PK4KO (14,130 T9) . . . . For the nonce, we'll put a question mark after HSICK (14,020 T9) and HS1BK (14,415 T9), on account of we've been told that HS1BJ is the only station in Siam.

## When:

Apparently the 80-meter transatlantic contacts aren't coming as easily this year as last, but they're there nevertheless. WI1KJ worked PAOAG, PAOSS, D4TFU and G2PL around midnight . . . . W8KWA worked G6WY (8570 T9) and heard HA4M (3500 T9), and ZL2DI working a W7 . . . . W3QV worked ZL2BT (4000) on 'phone, nice DX for the east coast . . . . However, honors go to G6WY. He is on nightly at 0530 GT, worked VU2AN (3620), and needs only South America for 3.5-Mc. WAC.

DX on 40 isn't bad at all, mainly because the average denizens there completely ignore it. But fellows like W3ATR look a little more closely and come back with all kinds of Europeans, some of the rarer variety like U5, LA and I . . . . Not to be outdone, W4ZZ worked OY4C, LX1AS (7235), YR5CJ (7285) and HA8G (7275), and heard ZBUU and CX3AH . . . . W1AJ reports YR5BK (7275), SP1YX (7215), G8OK (Channel Islands) and HI2S . . . . W3BGX got HR7WC (7305), CT2BJ (7195) and HI2S (7220) as well as the more common ones, and heard FA3WW (7090) and a lot of VK and ZL . . . . For Asiatic stuff we refer to W6PCP, who tells of XU8NA (7250 T9), XU8GW (7125 T8) and lots of J's, KA1AX (7155 T9), and KA1AS (7021).

No one will talk about 10 except WIWV and then only in a mild sort of way. At any rate he had a flock of 'phone contacts with Europe and Central and South America.

After being mighty close to peachy for several months, 20 took a dive, so by the time you get to this we don't know how it will be. But here's some of the stuff you may have missed in December and part of January . . . . W3UVA returned to the DX racket, and celebrated with VK9BW (14,370 T9x), HR7WC (14,420 T9x) and J2KG (14,430 T8) . . . . W8HWE worked VU2KK (14,280) and XU6D (14,410), the portable of XU9MK . . . . At W4EPT, KA1AX (7001), ZD2H (14,290) and CN8MI (14,270) got away, but VQ8AI (14,315 T9), KA1FG (14,100), CR7AF (14,270) and VP2RG (7240) didn't . . . . W6PAR grabbed VQ8AF (14,290 T9), CR7AG (14,295 T9), SU1SG (14,390 T9), ZP1AC (14,450 T9) and ZE1JG (14,365 T9), and his cohort W6NHA got ZS1CN (14,380 T9), ES1E (14,345 T9), CR7AD (14,380 T9) and HH4AS (14,410 T9) . . . . At W9YFV it's ZS3F (14,100 T9), PK1RI (14,330 T9), VU2FO (14,380 T9), VQ2MI (14,355 T9) and ZB1R

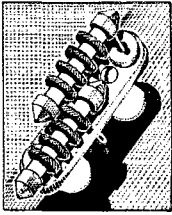

THERE is much interest at present in the application of the new Gammatron "24s" to high frequency oscillator and amplifier circuits. We have been having a lot of fun ourselves, with a pair of them as class C RF amplifiers on both the five and the ten meter bands. The RF output from a standard NTE-A exciter, is ample for excitation. The NC-600 neutralizing condensers have more than enough capacity and voltage range for the job as well as being of just about ideal mechanical proportions. For the output circuit, we are using the AR16 "air wound" coils, (to which line has just been added both 160 and 5 meter band units) along with one of the new small TMH35D 3000 volt split stator variables. The maximum capacity per section of this new condenser is 35 mmf. and the minimum 6 mmf.

And now let's return to where we left off last month on "suggestions received" for the better application of some of our products. By the addition of another hole, (diametrically opposite one of the end mounting holes) of the XR-13 and XR-13A coil forms, it becomes possible to rigidly mount these two forms by means of small angles or "spade lugs" to a chassis or to any of the PB-10A plug-in bases. Also, by enlarging the two end mounting holes slightly of the XR-16 Isolantite coil form this form can be readily fitted when desired with the standard small size GR banana plugs without the necessity of using an intermediate adapter or plug-strip. Of course, we still think that the best way to mount this form is on the PB-16 plug of our own! But then —

Incidentally the XB-16 base or socket strip, with its two small Isolantite cone shaped stand-offs makes a handy mounting for a pair of R-100 chokes where they are used in the grid or input circuit to a capacity coupled RF amplifier. The illustration above gives the general idea.

Of late, we have had quite a few calls for the old "40-75" frequency meter condenser. The answer is "yes" — we still make them and the net price is \$3.30. Also in this same connection, a single section version of the special condenser that we designed for our NC-81X Receiver is available for separate sale for frequency meter use. The type number is PW-81X-1, the net price \$3.00, the maximum capacity 25 mmf., the minimum capacity 6 mmf., and the frequency range approximately 1.07 to 1.00 for straight line frequency tuning with normal circuit padding. (7% frequency change or approximately the width of either the 10 meter or the 40 meter band.)

JAMES MILLEN



# A New Type of Push Button Switch

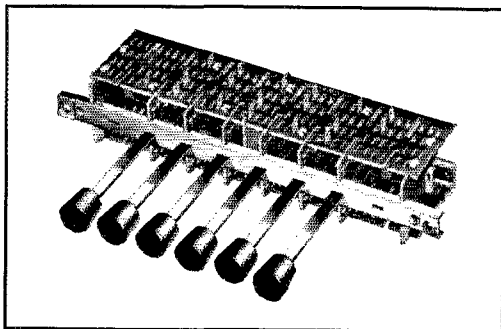

## for Meter Switching on Test Equipment, Analyzers, Tube Checkers and Radio Transmitters

The Mallory-Yaxley Type 2190 non-shorting switches provide new convenience, simplicity and economy in the construction and operation of radio test equipment. Through it a single current reading meter may be used to measure a number of circuits . . . the insertion of the meter in the circuit being accomplished merely by depressing a button. Other circuits connected to the switch remain closed and uninterrupted. Mallory-Yaxley Type 2190 switches are also suitable for meter switching on low and medium power radio transmitters, and public address systems where they replace with added safety, conventional jack and plug systems.

**P. R. MALLORY & CO., Inc.**

INDIANAPOLIS INDIANA

Cable Address—PELMALLO

Use

P. R. MALLORY & CO. Inc.

## MALLORY

APPROVED RADIO  
PRECISION PRODUCTS

---

Use

## YAXLEY

APPROVED RADIO  
PRECISION PRODUCTS

(14,300 T9) . . . . . W2KZP added to his log things like TF5C (14,000 T9), CN8AV (14,100 T9), VP5BR (14,140 T9), NY1AB (14,080 T9), YV4AE (14,035 T9) and HH3L (14,320 T9). He doesn't believe the J9CB (14,440 T8), and we don't blame him . . . . . W2IYO added J8CA (14,340 T9), J8CD (14,395 T9), XU2JN (14,370 T7c), U9AB (14,430 T9), VS6AO (14,350 T9) and VP8AD (14,330 T8c) . . . . . For the 'phone men, W8KWI has some tips in VS7GJ (14,100), CN1AF (14,270), PK6XX (14,000), ZB1L (14,110) and InQ (14,275), and W2CHK found ZS6W, ZS1BL, ZS3F, ZS2X, ZS6BR and ZS6EB between 14,050 and 14,100. W9VDY says TF3C (14,130) uses 'phone as well as c.w., so there's your Iceland contact . . . . . W6ITH reports VK7LZ (14,045) and CX2CO (14,100) a couple of new 'phones coming through rather well.

### What:

We made a mild pass at bum e.c.o.'s last month. Apparently it's a touchy subject with some of the lads, by the looks of their comments, and well it might be. We never knew anyone to be touchy about something he knew was right — it's only when one is just barely getting by, or not getting by at all, that he rises to defend himself at the slightest provocation. Which leads us to believe that too many have adopted the viewpoint that "So-and-so gets away with it — I guess I can." What an attitude!

Don't get us wrong. We're all in favor of quick-frequency-change and all the rest. It's just that we don't like to see the illusion we once had — that the DX men were the cream of the technical hams — shattered by having to listen to signals that weren't considered good even in 1930. Not that the e.c.o.'s give the only bum signals — there are plenty of poor c.c. ones with clicks and chirps — but they just seem to be more prevalent. Maybe we're trying to be a purist or something, but the regs say that "The frequency of transmission shall be as constant as the state of the art permits," and if the art permits some of the present signals it's in a helluva state.

(Jeeves, take away that thermometer. I'm *not* running a temperature!)

### Who:

W5VV heard URAK9 the other night, and called him just so he could say, "You are not a canine, you are a rat!" The BL really appreciated it, and said that Wilmer was the first in 53 contacts to catch on. We doubt if the BL will ever catch on . . . . . G8MF (14,385 T9) in the Channel Islands has QSL'd everyone he has worked, so get an envelope over to your QSL Manager if you haven't the card yet . . . . . The Ft. Worth (Texas) Radio Club and the Chattanooga (Tenn.) Amateur Radio Club combined cash, skill and discounts to build a compact phone-c.w. transmitter for Carrol Stegal, OQ5AE, the African missionary ham, on vacation in this country . . . . . W9IHH isn't quite sure, but he thinks he's lucky because WAC was represented in the first 12 cards he received during his first two months back on the air. (If that isn't luck we're going to throw away our printing press!) . . . . . Charles Cowden, VP4GA, is back in the States, at 177 N. Hill, Pasadena, Calif. . . . . Here's hoping you haven't judged HR7WC too harshly. There has been a delay in shipping his cards via W5ENE, but they'll be sent very soon. HR7WC tries to be on 7309 every Monday, Wednesday and Friday at 7 p.m., in case you're looking for him . . . . . Alan Eurich, W8IGQ and operator of WCFT, is now W7HFZ at Melville, Mont. . . . . You might go after the DX rag-chewing record of W8NBK and ZLIMR sometime. They had at it eight solid hours, so we'd suggest a little QRP unless you don't care what your power bill runs to . . . . . Speaking of records, K4KD finds that he has worked all but two of the DXCC members listed in December. The hold-outs are G6CL and E75F . . . . . Sorry we muffed it in an earlier edition, but the Call Book address of VQ8AI is correct . . . . . They did it again! Yes, the second All-Continent Round Table anniversary clicked on schedule, W4DLH, VU2CQ, HK5AR, VK4JU, SU1AM and G5ML all checking in within 1 minute and 50 seconds on the morning of January 4th. That's mighty good time for the 54,000 miles covered . . . . . John Shirley, ZL2JQ, who made so many friends during his brief stay in the States, is now working in England for a brief while. He plans to be back "down under" in June . . . . . W5BB and W5VV sked KF6DHW (14,380 T9), ex-W5BMP, for ulterior motives best known to

# WHY THOUSANDS OF HAMS ARE SWITCHING TO RAYTHEON RK 866!

only \$ 1.50

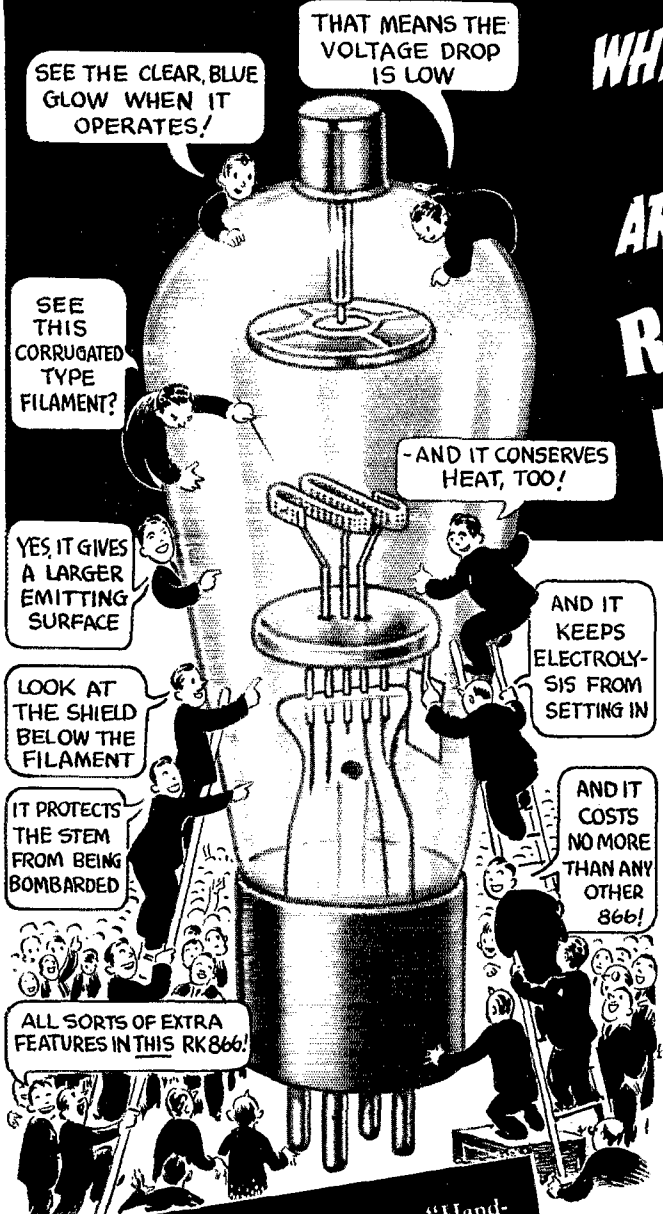

SEE THE CLEAR, BLUE GLOW WHEN IT OPERATES!

THAT MEANS THE VOLTAGE DROP IS LOW

SEE THIS CORRUGATED TYPE FILAMENT?

- AND IT CONSERVES HEAT, TOO!

YES, IT GIVES A LARGER EMITTING SURFACE

AND IT KEEPS ELECTROLYSIS FROM SETTING IN

LOOK AT THE SHIELD BELOW THE FILAMENT

AND IT COSTS NO MORE THAN ANY OTHER 866!

IT PROTECTS THE STEM FROM BEING BOMBARDED

ALL SORTS OF EXTRA FEATURES IN THIS RK 866!

*Don't forget* your copy of the "Hand-book of Amateur Tube Uses." It is just the thing to help you improve that old rig or build a new one. Your jobber or the nearest Raytheon office has a copy for you. Price 50c.

IT is not only what you see in the RAYTHEON RK 866, but also those features you cannot see that amaze countless commercials, airlines and amateurs that such a quality tube can be sold at such a price.

The long painstaking exhaust (not done on automatics), the elements meticulously processed, the few drops of double distilled mercury, and the careful testing of each tube. These are the **hidden values** in the Raytheon RK 866 that insure a long, trouble-free life. Yet it costs no more than any other 866. At your Parts Jobber for only \$1.50.

## RAYTHEON RK TRANSMITTING TUBES

NEWTON, MASS. • NEW YORK • CHICAGO • SAN FRANCISCO • ATLANTA

**"WORLD'S LARGEST EXCLUSIVE RADIO TUBE MANUFACTURERS"**

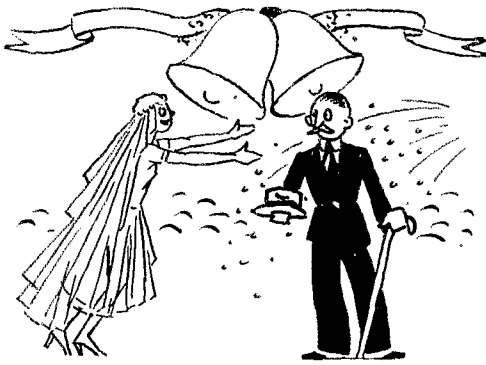

# Don't Compromise!

Don't compromise with make-shift changes and costly additions. Bring your station up-to-date with a new Harvey 100-T Transmitter — a profitable investment because advanced engineering guarantees performance and high trade-in value.

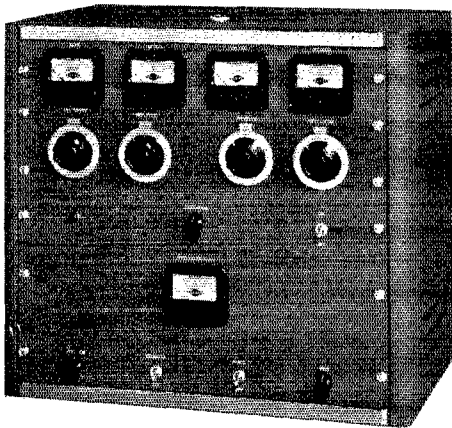

The modern cabinet, with hinged top, rounded corners, chrome trim and gray wrinkle finish, is only 19 inches high by 14 inches deep. When you listen to its signal on the air you'll agree that the 100-T delivers the "goods." We have a handsome new 1939 catalogue ready for you, which will give complete information on the 100-T. Write to Harvey Radio Laboratories, Inc., 25 Thorndike Street, Cambridge, Mass. Export: 25 Warren St., New York City.

themselves. Gosh, what some fellows won't do to seare up a new country . . . . VE2CR has a name for his bad luck. He figures that he just doesn't have "QSL appeal"! . . . . And now, if Mr. Kipling will look the other way:

If, when the Mrs. calls, you can go gladly  
And not mind playing contract bridge all night;  
If neither J's nor weak PK's intrigue you,  
If low grid mills and stone-cold plates seem right,  
If you put up with "pretty good" receivers,  
Or "fair" skywires — when better can be had —  
Yours is the earth and everything that's in it —  
But you won't make the Century Club, my lad!  
— WJPE

## Hamfest, Rochester, N. Y.

The Rochester Amateur Radio Association will hold its annual hamfest and banquet on Saturday, February 4th, at the Seneca Hotel, Clinton Ave. South, Rochester, N. Y. Registration begins at 4:00 p.m. A turkey dinner will be served and several speakers will provide a program of interest to all amateurs. Tickets are \$2.00. For advance registration and further information communicate with Mr. William Hamp, 194 Forgham Rd., Rochester.

## Second Eastern DX Round-Up

The Telcoi Radio Club will be host to the second eastern DX Round-Up at the Telephone Building, 101 Willoughby St., Brooklyn, N. Y., on February 25, at 8 p.m. William J. McGonigle, president of the club and of the Veteran Wireless Association, is general chairman; Arthur Lynch, W2DKJ, toastmaster; Ralph Thomas, W2UK, chairman of the reception; and Dorothy Hall, W2IXY, secretary. There will be several speakers who are outstanding in the radio field. Admission will be twenty-five cents, to cover the cost of the coffee and sandwiches. As is the custom, all DX-minded hams are cordially invited — no others need apply.

## Exhibit Station — Schedules Wanted

Amateurs of New Bedford, Mass., plan to again have an amateur radio exhibit at the Hobby Show held in that city each February. Emergency rigs and equipment will be on display and in operation under the leadership of C. Leo Riley, Jr. (W1JJY), Regional Coördinator and R.M. E. Mass., and an outlet for traffic will be available through station W1JJY, remote-controlled from the booth. Provision is also being made for operation on 3.9-Mc. 'phone (W1LZF) by remote control, and for an actual station at the Hobby Show in addition to JJY and IZF. Schedules are requested to facilitate efficient traffic handling. W1JJY will use 3745 kc. (E. Mass. O.R.S. Net frequency). Any operators interested in arranging schedules for handling the Show traffic should get in touch with W1JJY (43 Sycamore St., New Bedford, Mass.) by February 1st.

A study by W6KMM of W6KFC's log covering operation during the '38 SS Contest shows that all states were worked in 27 hours, 7 minutes operating time. This somewhat betters W6MYK's '37 SS record (all states in 29 hours). During the April '36 O.R.S. Party W6KFC worked all W districts in 44 minutes.

W8AVF and W8GWT, both of Penn Yan, N. Y., have been hamming together for about eight years. For the past year W8AVF has needed Arkansas and Mississippi for W.A.S. One night in December he got on 7 Mc. and hooked W5GHT for his first Arkansas QSO. A few nights later on the same band he raised W5AVF for first Mississippi contact!

On the afternoon of December 18, 1938, W3VB's CQ on 3620 kc. resulted in a QSO with W1VB. At the end of this contact, another station was heard calling W1VB and W3VB and signing W8VB. Result: A three-way between W1, W3 and W8VB.

# COMPENSATING CERAMIC CAPACITOR by CENTRALAB

OSCILLATOR FREQUENCY DRIFT

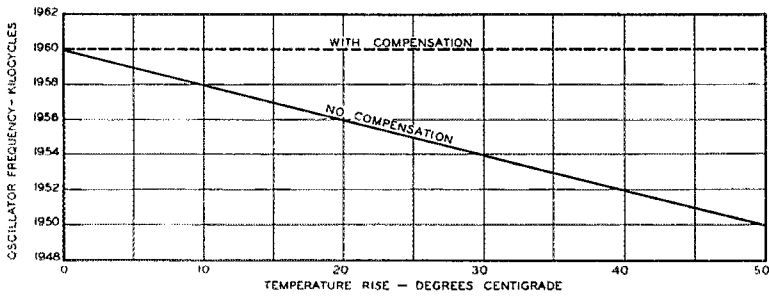

Centralab fixed capacitors consist of a thin wall ceramic tube spacing two tubular condenser plates, electroplated on the ceramic. Capacitance remains permanent under all life and aging tests. Centralab capacitors do not depend upon pressure fit for contact at any point, but have a positive soldered joint between plates and wire leads. All capacitors are vacuum impregnated with wax and coated with a moisture-proof film of low power factor resin.

A special bulletin showing engineering data available on request. Specify Bulletin 630

# Centralab

DIVISION OF GLOBE UNION  
Milwaukee, Wisconsin

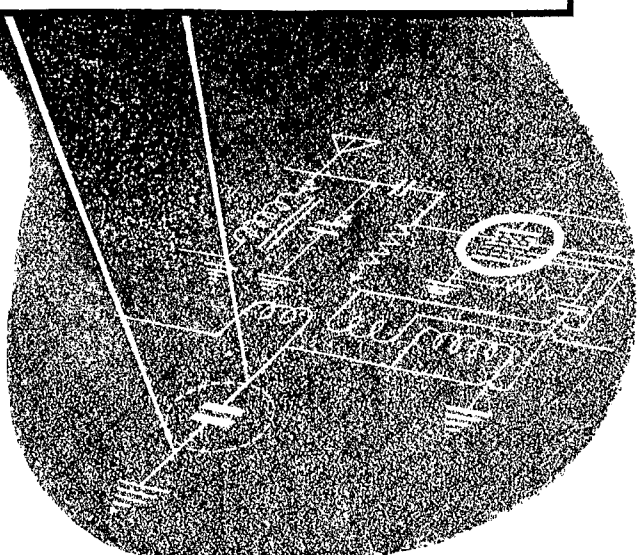

# IN WORKING CLOTHES!

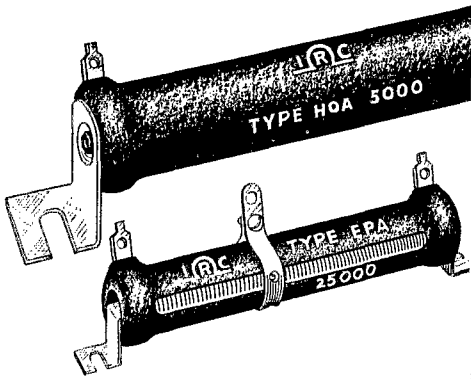

**WE** have designed IRC Power Wire Wound Resistors for hard work and dressed them in working clothes. Their winding forms are tough, non-porous ceramic. Their rugged cement coating is dark and rough for rapid heat dissipation, but it protects the winding in the most severe humidities. We fit them with stout terminals that won't break off. There is no firing process to bake the temper out of the windings and terminals. In short, they are not designed for beauty, but to do their job—to dissipate heat and stay put.

In aircraft radio and submarine signalling equipment, where there must be no failures, they furnish the extra margin of safety.

Your IRC parts jobber carries them in standard ranges, both fixed and adjustable types, from 10 to 200 watts. Use them and see for yourself why they are preferred in the most critical services.

**INTERNATIONAL RESISTANCE CO.**  
401 N. BROAD ST., PHILADELPHIA, PA.



... AIRPLANE -  
SUBMARINE  
RESISTANCE  
DEPENDABILITY  
... AT NO EXTRA COST



*Cement Coated*

**POWER WIRE WOUND RESISTORS**

## MEMBERS, DX CENTURY CLUB

G6WY (No. 5)...	141	W3CHE (No. 87)...	108
W1TW (No. 3)...	133	W6HX (No. 21)...	107
W1SZ (No. 7)...	133	G6CL (No. 24)...	107
W6CXW (No. 4)...	132	VK5WR (No. 49)...	107
W6GRL (No. 15)...	132	W1JPE (No. 66)...	107
W8DFH (No. 14)...	131	W9FS (No. 77)...	107
W2GTZ (No. 12)...	130	W2AAL (No. 81)...	107
W2GT (No. 32)...	130	G5BJ (No. 93)...	107
W8BTI (No. 56)...	129	W2HHF (No. 54)...	106
GZQO (No. 6)...	128	W3DDM (No. 72)...	106
W8CRA (No. 1)...	127	PA0XF (No. 43)...	105
W1TS (No. 9)...	126	W6FZL (No. 48)...	105
W2GW (No. 11)...	125	W2CYS (No. 52)...	105
ON4AU (No. 40)...	125	W2DC (No. 79)...	105
W1LZ (No. 10)...	122	W3EVT (No. 51)...	104
W9ARL (No. 18)...	122	W8BKP (No. 65)...	104
W8DHC (No. 27)...	120	W2CMY (No. 68)...	104
W1DF (No. 29)...	120	W2GVZ (No. 80)...	104
HB9J (No. 13)...	119	W2ZA (No. 88)...	104
W1BUX (No. 2)...	118	D4AFF (No. 99)...	104
W9KG (No. 16)...	118	E15F (No. 19)...	103
W8OSL (No. 23)...	118	G6KPK (No. 45)...	103
W5BB (No. 37)...	118	W4CYU (No. 78)...	103
J5CC (No. 46)...	118	G2TR (No. 83)...	103
W2UK (No. 33)...	116	W1CH (No. 91)...	103
W3EMM (No. 58)...	116	W4CBY (No. 20)...	102
W1FH (No. 71)...	116	W1WV (No. 69)...	102
W8LEC (No. 25)...	115	VE2AX (No. 84)...	102
W6KIP (No. 28)...	115	W8NJP (No. 90)...	102
W8ADG (No. 63)...	115	W5KC (No. 92)...	102
W9PST (No. 35)...	114	F8RJ (No. 8)...	101
W9TJ (No. 67)...	114	W2CJM (No. 47)...	101
W8DWW (No. 17)...	113	VK3KX (No. 57)...	101
W8JMP (No. 22)...	113	ZL1HY (No. 59)...	101
W8OQF (No. 30)...	112	W1ZB (No. 62)...	101
G6RH (No. 36)...	112	W2OA (No. 73)...	101
W9KA (No. 42)...	112	W4AJX (No. 75)...	101
W9EF (No. 44)...	112	W6DOB (No. 76)...	101
W6GAL (No. 50)...	112	W1DUK (No. 82)...	101
W4CEN (No. 60)...	112	W2CBO (No. 86)...	101
W4BPD (No. 70)...	112	W9TB (No. 95)...	101
W7AMX (No. 26)...	111	W3GAU (No. 96)...	101
W2BHW (No. 39)...	111	G5RV (No. 64)...	100
ON4AU (No. 31)...	110	W3FRY (No. 85)...	100
W6ADP (No. 34)...	110	SU1WM (No. 89)...	100
W5V (No. 38)...	110	W4DRD (No. 94)...	100
W9GDH (No. 41)...	110	W8EUY (No. 97)...	100
W3EUV (No. 55)...	110	F8RR (No. 98)...	100
W3EPV (No. 74)...	109	W2DSB (No. 100)...	100
W3EDP (No. 53)...	108	G2DH (No. 101)...	100
W9ADN (No. 61)...	108	W2BYP (No. 102)...	100
G5QY (No. 103)...		100	

The following have submitted proof of contacts with 75-or-more countries.

PA0QF ... 99	W8KEG... 89	SM6WL... 79
W1CC ... 99	G2DZ ... 88	W3AOD ... 79
W9UM ... 99	PA0QZ... 88	W4EQK ... 79
W3AG ... 98	W3BEN... 88	W6LDJ ... 79
W1FTR ... 96	W3JM ... 88	W9RBL ... 79
W1GDY ... 95	W4CCH... 87	G8YR ... 78
FB8AB ... 93	W9AEH... 87	VE2GA ... 78
G6GH ... 93	W1HX ... 86	W1EWD ... 78
VE2EE ... 93	W2IOP... 86	W4TZ ... 78
W1BGY ... 93	W3AIU... 86	W8AAT ... 78
W1GCX ... 93	W3KT ... 86	W8BFG ... 78
W1ZI ... 93	W9FLH... 86	W8FJN ... 78
W3BES ... 93	W6FKZ... 85	W8MTY ... 78
W6BAM ... 93	VK6SA ... 84	W9BEZ ... 78
W6GHU ... 93	W2GRG... 84	W1ICA ... 77
W8BOX ... 93	W3AGV... 84	W6AM ... 77
W8OXO ... 93	W3OP ... 84	W6KUT ... 77
G2MI ... 92	W4CFD... 84	W6TT ... 77
HB9BG ... 92	W8BSF... 84	G6XL ... 76
G6NF ... 91	W9OVU... 84	W3AYS ... 76
W1GNE ... 91	G8ZO ... 83	W8LZK ... 76
W8DOD ... 91	SP1AR... 83	ZELJ ... 76
J2JJ ... 90	W2BMX... 83	Z8Z ... 76
W1RY ... 90	W5ASG... 83	PA0JMW... 75
W8KTW ... 90	W1BFT... 82	SP1LP ... 75
W9CWW ... 90	W6GFP... 82	W3CKT ... 75
G5BD ... 89	W3EMA... 81	W3PFL ... 75
HB9X ... 89	W8IQB... 81	W8DAE ... 75
W3ZX ... 89	W9RCQ... 81	Radiotelephone
W6ITH ... 89	W2AER... 80	W4CYU ... 78
W8AAJ ... 89	W3BVN... 80	W2XYU ... 77
W8AU ... 89	W3EPR... 80	W6ITH ... 76
W8CJJ ... 89	W3GEH... 80	
	LU7AZ... 79	



# FREQUENCY STABILITY IS *Insured*

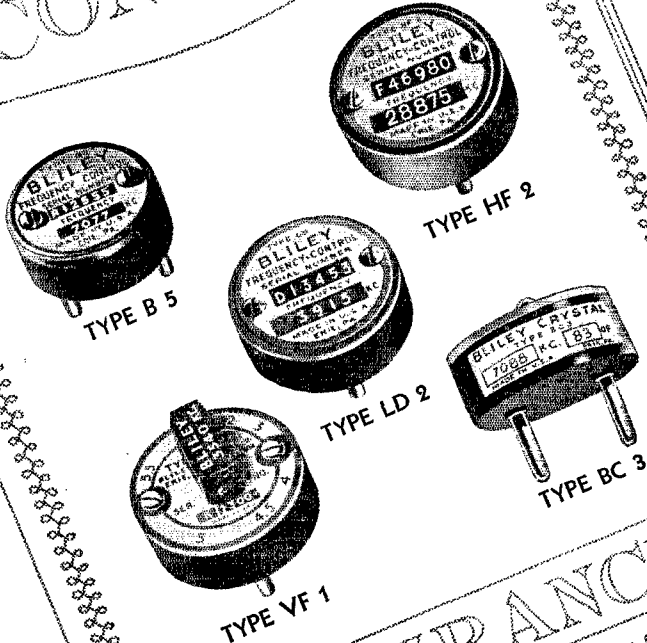

*with*

# BLILEY CRYSTALS

THE safest, surest and most simple method of realizing high frequency stability in an amateur transmitter is the use of correctly ground quartz crystals. A tried and proven method of obtaining proper quartz crystals is to specify BLILEY.

Question any experienced amateur as to what company manufactures the most complete line of quartz crystal units; what company has accomplished the most in developing new cuts, high frequency units and variable frequency units; and what company is continually striving to improve existing quartz crystals or to develop new ones to meet new demands as radio communication progresses. Invariably you will receive one answer — BLILEY!

Your Bliley distributor can give you full information on any crystal unit which you may require (or send

for circular A-6). For your guidance, the complete line is listed below.

10 meters	+43 cycles/mc./°C.	Type HF2.....	\$5.75
20 meters	+20 cycles/mc./°C.	Type HF2.....	5.75
20 meters	± 4 cycles/mc./°C.	Type B5.....	7.50
40 meters	± 4 cycles/mc./°C.	Type B5.....	4.80
80-160 meters	± 4 cycles/mc./°C.	Type LD2.....	4.80
40-80 meters	-23 cycles/mc./°C.	Type BC3.....	3.35
160 meters	+20 cycles/mc./°C.	Type BC3.....	3.35
40-80 meters, (variable frequency)		Type VF1.....	7.50

# BLILEY CRYSTAL UNITS

# Never Before

## PANEL INSTRUMENT VALUES LIKE THESE

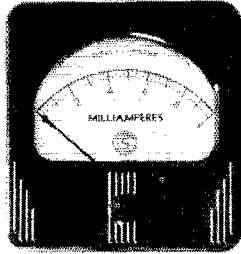

**UNQUESTIONABLY** a new high in panel instrument value was registered when we introduced the expensive bridge type construction and soft iron pole pieces at prices no higher than you formerly paid for ordinary instruments. But now even these great values have been further increased by the sensational price reductions listed here:

### R. F. AMMETERS

Internal thermo-couple radio frequency ammeters (1, 1½, 2, 2½, 3 or 5 Amps.) **\$4.59**  
Your net price.....

### HIGH RANGE VOLTMETERS

D. C. plate voltmeters, complete with external resistors, (1,000 - 1,500 - 2,000 - 2,500 - 3,000 or 4,000 volts). Your net price.... **\$8.90**  
(5,000 volt range, \$12.00 net.)

### DECIBEL METERS

Rectifier type volume level indicator [-10 to +6 db (500 ohm line; 6 M.W.)] **\$7.84**  
Your net price.....

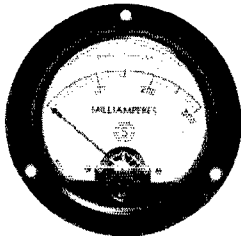

Other Outstanding Values Are:

● D. C. plate milliammeters (all popular ranges from 0.5 to 0-1000 milliamps) list, \$6.35; net price to you..... **\$4.15**

● A. C. filament voltmeters (0-10 or 0-15 V.) list \$6.35; net price to you..... **\$4.15**

Illuminated dials for all popular ranges, including 6 V. lamp and socket, 50c net additional.

Two of these Simpson instruments are illustrated here. To fully appreciate their finer construction, you must—

*See them  
at your jobber's*

See our  
announcement  
of the new  
Simpson  
"Hammer"  
on page 85.

# SIMPSON

**INSTRUMENTS THAT STAY ACCURATE**

SIMPSON ELECTRIC CO., 5216-18 W. Kinzie, Chicago

### ELECTION NOTICES

To all A.R.R.L. Members residing in the Sections listed below: (This list gives the Sections, closing date for receipt of nominating petitions for Section Manager for the present incumbent and the date of expiration of his term of office.) This notice supersedes previous notices.

In cases where no valid nominating petitions have been received from A.R.R.L. members residing in the different Sections in response to our previous notices, the closing dates for receipt of nominating petitions are set aside to the dates given herewith. In the absence of nominating petitions from Members of a Section, the incumbent continues to hold his official position and carry on the work of the Section subject, of course, to the filing of proper nominating petitions and the holding of an election by ballot or as may be necessary. Petitions must be in West Hartford on or before noon of the dates specified.

Due to a resignation in the Eastern Massachusetts Section, nominating petitions are hereby solicited for the office of Section Communications Manager in this Section, and the closing date for receipt of nominations at A.R.R.L. Headquarters is herewith specified as noon, Wednesday, February 15, 1939.

Section	Closing Date	Present SCM	Present Term of Office Ends
Manitoba *	Feb. 1, 1939	A. J. R. Simpson	Feb. 15, 1939
No. New Jersey	Feb. 1, 1939	Fred C. Read	Feb. 15, 1939
Arkansas	Feb. 1, 1939	H. E. Velte	Feb. 15, 1939
Eastern Mass.	Feb. 15, 1939	Sam Gross	.....
		(resigned)	
Nevada	Feb. 15, 1939	Edward W. Heim	June 14, 1937
Vermont	Feb. 15, 1939	Alvin H. Battison	Apr. 15, 1938
Nebraska	Feb. 15, 1939	S. C. Wallace	Aug. 17, 1938
Mississippi	Feb. 15, 1939	J. H. Weems, Jr.	Oct. 1, 1938
Philippines	Feb. 15, 1939	George L. Rickard	Oct. 15, 1938
San Joaquin Valley	Feb. 15, 1939	Angelo V. Astone	Dec. 15, 1938
East Bay	Apr. 3, 1939	H. J. Burchfield	Apr. 15, 1939
New Mexico	Apr. 3, 1939	Joseph M. Eldodt	Apr. 15, 1939
Rhode Island	Apr. 3, 1939	Clayton C. Gordon	Apr. 15, 1939
Western Florida	Apr. 3, 1939	Ellis R. Curry	Apr. 15, 1939
Indiana	Apr. 3, 1939	Noble Burkhardt	Apr. 15, 1939
New York City & Long Island	Apr. 14, 1939	Edward L. Baumach	Apr. 22, 1939
San Francisco	May 15, 1939	Alan D. Whittaker, Jr.	May 28, 1939

\* In Canadian Sections nominating petitions for Section Manager must be addressed to Canadian General Manager, Alex Reid, 169 Logan Ave., St. Lambert, Quebec. To be valid such petitions must be filed with him on or before the closing dates named.

1. You are hereby notified that an election for an A.R.R.L. Section Communications Manager for the next two year term of office is about to be held in each of these Sections in accordance with the provisions of the By-Laws.

2. The elections will take place in the different Sections immediately after the closing date for receipt of nominating petitions as given opposite the different Sections. The Ballots mailed from Headquarters will list in alphabetical sequence the names of all eligible candidates nominated for the position by A.R.R.L. members residing in the Sections concerned. Ballots will be mailed to members as of the closing dates specified above, for receipt of nominating petitions.

3. Nominating petitions from the Sections named are hereby solicited. Five or more A.R.R.L. members residing in any Section have the privilege of nominating any member of the League as candidate for Section Manager. The following form for nomination is suggested:

(Place and date)

Communications Manager, A.R.R.L.,

38 La Salle Road, West Hartford, Conn.

We, the undersigned members of the A.R.R.L. residing in the..... Section of the..... Division hereby nominate..... as candidate for Section Communications Manager for this Section for the next two-year term of office.

(Five or more signatures of A.R.R.L. members are required.)

The candidates and five or more signers must be League members in good standing or the petition will be thrown out as invalid. Each candidate must have been a licensed amateur operator for at least two years and similarly, a member of the League for at least one continuous year, immediately prior to his nomination or the petition will likewise be invalidated. The complete name, address, and station call of the candidate should be included. All such petitions must be filed at the headquarters office of the League in West Hartford, Conn., by noon of the closing date given for receipt of nominating petitions. There is no limit to the number of petitions that may be filed, but no members shall sign more than one.

4. Members are urged to take initiative immediately, filing petitions for the officials for each Section listed above. This is your opportunity to put the man of your choice in office to carry on the work of the organization in your Section.

— F. E. Handy, Communications Manager

### ELECTION RESULTS

Valid petitions nominating a single candidate as Section Manager were filed in a number of Sections, as provided in our Constitution and By-Laws, electing the following officials, the term of office starting on the date given.

Quebec	Lindsay G. Morris, VE2CO	Dec. 14, 1938
Oregon	Harold W. Johnston, W7DXF	Dec. 15, 1938
Colorado	Carl C. Drumeller, W9EHC	Dec. 17, 1938
Louisiana	Eugene H. Treudaway, W5DKR	Jan. 14, 1939

In the Georgia Section of the Southeastern Division

# ZENITH RADIO CORPORATION

—6001 DICKENS AVENUE—

CHICAGO

January 15, 1939

OFFICE OF  
E. F. McDONALD, JR.  
PRESIDENT

To Radio Amateurs:

This is an invitation to every "ham" in the world.

Most advertisers in magazines, newspapers, etc., tell you how to spend your money. This is not that type of message.

I have always contended that the credit for most of the major developments we have in radio have been due to the American amateur. The radio industry's enormous laboratories have done little but refine that which the amateur discovered. The Zenith Radio Corporation is always ready to reward amateurs who send us suggestions that we have not before had, if we adopt them.

We haven't an engineer in our laboratory over forty years old - they're all ex-"hams," progressive and very much open-minded. To them nothing is impossible. We have found that it is not always the fellow who knows all the rules of why things won't work that produces real results. As a matter of fact, the contrary is usually true.

If you want to see an example of development, drop into a Zenith dealer's store and examine the Wavemagnet model of radio, just put on the market, using no antenna, ground or battery. This is not a set built for "hams." This job was suggested by an amateur and the improved shielded loop was refined by our laboratory. If you know how to build this loop better, tell us and, if your suggestion is novel and we adopt it, we will reward you.

So, you see this was not an ad telling you how to spend your money. It is just an invitation for more of you to correspond with us on further developments.

Cordially yours,

*E. F. McDonald Jr.*

HC

No. 842 L A.C.—D.C.—VOLT—OHM—DECIBEL—MILLIAMMETER—AMMETER

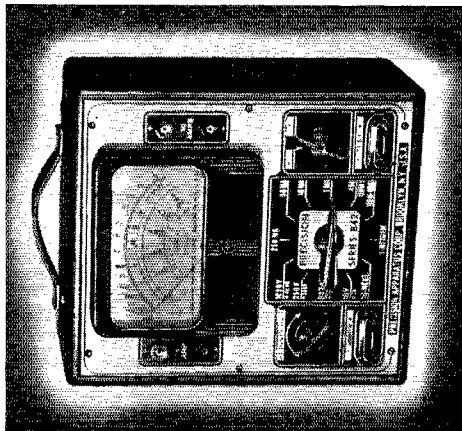

## Two Popular "PRECISION" Testers

### SPECIFICATIONS

Five A.C. and D.C. Voltage Ranges at 1000 ohms per volt: 0-10; 0-50; 0-250; 0-1000 VOLTS; 0-10; 0-100; 0-250; 0-1000 volts.  
 Six D.C. Current Ranges: 0-1/10; 0-1/50; 0-1/250 MA. and 0-1; 0-10 AMPS.  
 Four Resistance Ranges: 0-100; 0-1000; 0-10,000; 0-100,000 Ohms.  
 Five Decibel Ranges from -10 to +48DB; +14DB; +28DB; +40DB; +48DB.  
 Five Output Ranges (Same as A.C. Ranges).  
 Large 4 7/8 inch square meter.  
 Wire Wound Shunts and metallized multipliers, both of 1% accuracy.

Five D.C. Voltage Ranges at 1000 ohms per volt: 0-10; 0-100; 0-250; 0-1000 volts.

Four D.C. Current Ranges: 0-1; 0-10; 0-100; 0-250 MA.

Two Resistance Ranges: Low ohms (shunt method) 1/2 to 500 ohms.

High ohms 0-300,000 ohms.

Ohmmeter Ranges are powered by self contained supply.

Other Features: Large 3" square meter.

D'Arsonval movement 2% accuracy adjust ohms compensator; attractive metal etched panel; walnut finished wood case with carrying strap self contained battery included; compact size 7 x 4 1/4 x 2 1/2.

NET PRICE.....\$10.95

Less Batteries and test leads

NET PRICE \$21.95

Available at leading Parts Jobbers

No. 830 D.C.—VOLT—OHM—MILLIAMMETER

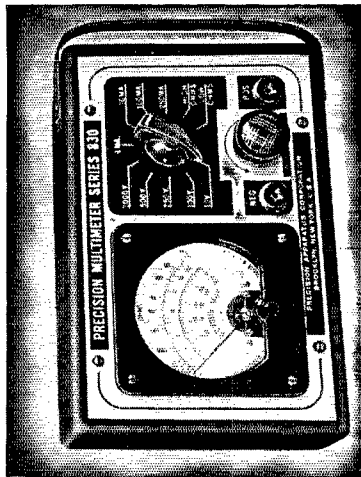

**PRECISION APPARATUS COMPANY**  
 821 EAST NEW YORK AVENUE • BROOKLYN, NEW YORK  
 EXPORT DIVISION, 458 BROADWAY, NEW YORK, U. S. A.—CABLE ADDRESS: MORHANEX

Mr. Leland W. Smith, W4AGI, and Mr. Jimmie Walker, W4VX, were nominated. Mr. Smith received 59 votes and Mr. Walker received 32 votes. Mr. Smith's term of office began November 29, 1938.

## F. C. C. Emergency Regulations

(Continued from page 71)

noncompliance which may serve as a basis for investigation and action under section 502 of the Communications Act. Policing authority extends only to 1715-2000 and 3500-4000 kilocycle bands. Individual policing transmissions shall refer to this section by number, shall specify the date of the Commission's declaration, the area and nature of the emergency, all briefly and concisely. Policing-observer stations shall not enter into discussions beyond essentials with the stations notified, or other stations.

"(e) These special conditions imposed under this section will cease to apply only after the Commission shall have declared such emergency to be terminated."

### HOW THE REGULATIONS APPLY

As soon as the F.C.C. is informed of a threat of some state of emergency involving communications, it carefully examines all the facts, to determine the seriousness of the situation, the area concerned and the desirability or need for an emergency declaration to assist the amateurs that would automatically be concerned with emergency traffic. The Commission may confer with the American Radio Relay League, the American Red Cross, and government agencies concerned in arriving at a decision to meet any emergency situation.

Assuming that the situation warrants the recognition of a state of communications emergency, the F.C.C. will act immediately, exactly in accordance with its stipulations under Section 152.54 of the Rules Governing Amateur Radio Operators and Stations, and "declare" a state of general communications emergency. The press, broadcasting stations, A.R.R.L., etc., will be notified, to give legal force and practical effect to the announcement. The representative amateur organization, your A.R.R.L., will consult its always-ready records of appointees and officials working by particular bands and modes in order to recommend to the Commission, the amateur stations in the best position to be designated by the F.C.C. to promulgate the emergency announcement in the different band segments, and for thereafter policing these bands, warning non-complying stations, and reporting fully on their operations and observations to the Commission for the whole period of a particular emergency. There is a constant state of change in personnel and activity, and only a thoroughgoing national organization such as A.R.R.L. is in a position to maintain the Emergency Corps registrations, frequency band information, and monthly station activity data in a sufficiently up to date state so that at any given moment proper recommendations may be formulated.

How will you know that emergency regulations are in effect? Perhaps from your local paper, or direct from a W1AW "QST," or you may hear some stations handling emergency traffic (in which case you shut down and listen until you get confirming or contrary information). You will undoubtedly hear one of the 60 or 70 F.C.C.-designated stations sending the official announcement, and referring to Sec. 152.54 by number exactly as specified in 152.54 (d).

What to do. First off, if you have a license of whatever class, you should already be registered in the A.R.R.L. Emergency Corps, and familiar with the plans formulated by your Emergency Coordinator. The first step should be to report to him what you know of the situation, and tell him that you are ready to stand by, or assist in any practical manner. If you are not yourself in an area where communications emergency conditions exist, you may still be near enough to make absolute silence the best form of co-operation, unless you definitely log an emergency station giving a directive call for you or for your very city. If you are in an affected area you will be guided completely by the suggestions of the amateur service Emergency Coordinator who will be already in touch with the Red Cross, with civic and military officials, and agencies to be served. He may be able to assign you to a job to be done for the weather forecaster, or other work. There will be need for relief operators for stations strategically located, for second operators to handle telephones and message deliveries, for messenger service.

# Guaranteed!

*never to fail—as a result  
of gas released internally*

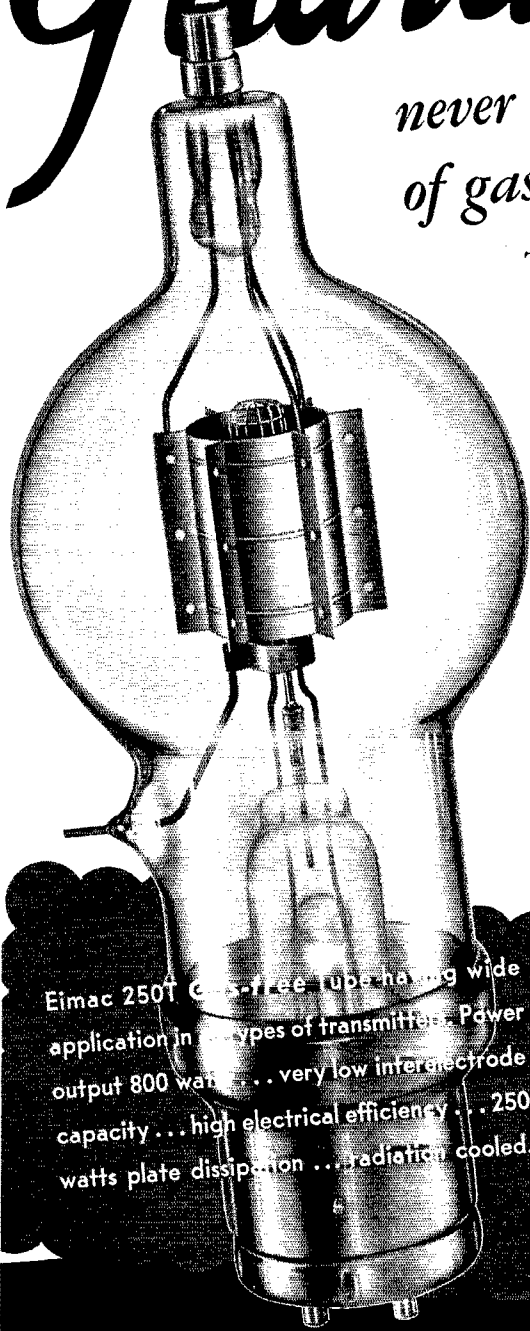

The use of specially treated tantalum for grids and plates—long severe exhaust—complete elimination of “getter” and the development of a new type thoriated tungsten filament makes Eimac tubes practically failure proof. The source of premature failure—GAS—has been removed by an exclusive process. Eimac tubes provide an extra degree of safety—stand accidental or intentional overloads of 400% to 600% without damage. Results speak for themselves. Everywhere—in every kind of application—Eimac tubes are establishing astounding records for dependability. See your dealer or write.

Eimac 250T gas-free tube having wide application in all types of transmitters. Power output 800 watts . . . very low interelectrode capacity . . . high electrical efficiency . . . 250 watts plate dissipation . . . radiation cooled.

**Eimac**  
TUBES

**EITEL-McCULLOUGH, INC.**  
SAN BRUNO, CALIFORNIA

# ★ Now 500 and 1000 WATT CARDWELL MULTI-BAND CONDENSERS

Responding to the demands of many of our good friends in the H.P. amateur phone group, we are glad to present two new multi-section condensers, designed to yield efficient balanced capacity values for the 10-, 20- and 80-meter phone bands.

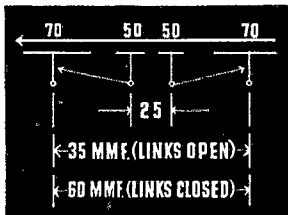

The basic diagram indicates the maximum capacities per section and the effective maximum capacities of the 3 balanced (series stator) groups.

Reference to manufacturers' tables of required capacities to resonate with such standard tank inductors as B. & W., Coto etc., discloses how nicely these effective ranges match their coils for 10-, 20- and 80-meter phone and 40-meter C. W. bands.

## ★ 1000 WATT Multi-Band TYPE TL-70-50-UQ

Frame — "T" type commercial (heavy N.P. brass construction)  
Airgap — .294"  
Plates — .050" thick aluminum, buffed and polished  
Insulation — G. E. Mycalex  
List Price . . . . . \$40.00  
Amateur Net Price . . . . . \$24.00

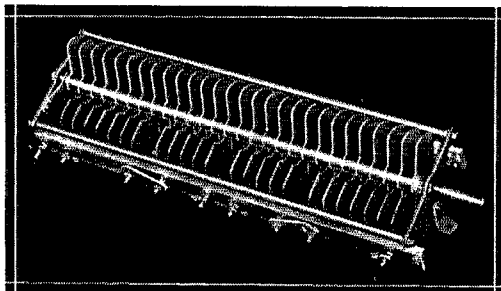

XG-70-50-XQ

## ★ 500 WATT Multi-Band TYPE XG-70-50-XQ

Frame — "X" standard, N.P. brass, sturdy construction  
Airgap — .171"  
Plates — .040" thick aluminum, buffed and polished  
Insulation — G. E. Mycalex  
Length — 13 inches back of panel  
List Price . . . . . \$19.00  
Amateur Net Price . . . . . \$11.40

Do not fail to read T. M. Ferrill's article on page 37, December 1938, "QST" on how to properly block D.C. from tank condensers.

And see Taylor tubes 1939 catalog, page 36 for a 10-160-meter, 150 watt phone built around the Cardwell XE-160-70-XQ Multi-band condenser, which many of you are already using.

**THE ALLEN D. CARDWELL  
MANUFACTURING CORPORATION**  
83 PROSPECT STREET, BROOKLYN, NEW YORK

Should there not be a Coördinator, work direct with agencies served is in order, with careful respect for the priority of official and public aid messages. S.C.M.'s are aiming to appoint Coördinators to represent the amateur service in every city or town, where a live amateur capable of doing organization work is available — and will appreciate your help and suggestions.

You have contacted the Coördinator, and carefully reviewed the situation. He has been busy modifying his tentative plans, based on studies of "possible" local contingencies, to make the most effective disposition of local amateur resources possible to meet this "exact" communications emergency situation. He has been in touch with other communication people — the broadcasters, the wire services, the police, airways and agencies served. Even the first set up must be modified from hour to hour to meet changes in the situation, reach new points, reduce local interference, cover the important circuits with the more skilled and efficient operators. If you have been registered in the A.E.C. much that you have done is what you expected to do, if not, you may have been able to help, self-powered or not, but you may have had to pick up a lot of the local plans and situations right from scratch, without the benefit of previous discussions.

One thing certain, however: You have refamiliarized yourself with every word of the F.C.C. emergency regulation so that 152.54 is much more than a number to you — more like carefully observed "religion."

The communications bands for emergency purposes become 1715-1975, and 3525-3975 kcs. In the 25 kcs. on the band edges, 1975-2000, 3500-3525, and 3975-4000 kcs. ONLY CALLING is permitted. These band segments are reserved by the F.C.C. for emergency calling. The routine calls that precede traffic transmission and other emergency communications work are all in the communications band, not in the "calling" frequencies.

**The listening period.** Everyone engaged in operating in these low frequency bands with relief and emergency traffic must stop and observe the five minute hourly quiet period (0000-0005) unless his particular message is of utmost priority, or of life-and-death urgency. The purpose of the listening period is to enable every participating amateur to "bear down" on looking for calls from isolated, low power emergency stations, that might otherwise be buried in QRM and unable to get through. Only such stations, with the priority that first news of a dire plight, and other stations with extremely important, over-due official messages, should use listening periods to send a call of any kind! The one-in-a-thousand amateur station that should use the listening period to transmit must use intelligence too, and make his CQ or QRR directional or specific as to his situation so the stations not in the proper spot to help will keep quiet and keep interference down. *No calls may be answered until the first-five-minute listening periods are over!*

Note how specific the Commission's prohibition or restriction of 1.8- and 3.5-Mc. band work is! *Casual* conversation, *incidental* (unrelated to the emergency) calling, testing, or working, remarks *not pertinent* to constructive handling of the communications emergency situation, "shall be prohibited." The F.C.C. designates some assisting amateur stations (152.54 d), and these will report stations failing to comply with any part of the emergency rules. While there are limitations on the authority of the observer-policing stations, and they act when possible in an advisory capacity (not conflicting with the more vital authority of coördinators in the affected areas themselves) there is the expressed intention of the Commission to fully examine the reports of the designated operators, taking any necessary disciplinary investigations and action for delinquencies noted. A few individuals have shown an improper, unconstructive attitude, or lack of cooperation on a few occasions in past emergencies, and the large body of organized amateur radio, cheerfully making itself ready to serve in emergencies, will heartily cheer the regulation that has been set up to deal with such cases as the future may bring.

The spirit of the day requires that every amateur give thought to Preparedness to serve in emergencies, by personal training in formulating, and systematically handling traffic, and by the acquisition of self-powered equipments, where possible. The new regulations cover a lot of ground and every ham should familiarize himself with every portion of them. Also we again invite every licensed amateur to get his equipment registered in the A.R.R.L. Emergency Corps as soon as he can drop a card for the necessary blank, if not already a member.

— F. E. H.

# Introducing "HAMMETER" ★

The New SIMPSON

★ The first self-contained, pocket portable instrument built expressly to check high voltage and all component parts of transmitters and receivers.

## 3,000 VOLTS—SELF-CONTAINED

No external multipliers necessary

THE happy thought of a 3,000 volt instrument has been spoiled for many amateurs by a sidelong glance at the price tag. But now the thought is all happy. We wish there were some way to hide the price of this new "Hammeter" until you have read this brief description and seen the instrument. If that could be done, you would have the surprise of your life.

The heart of the "Hammeter" is the time tested Simpson D'Arsonval movement with costly bridge-type construction and soft iron pole pieces—a meter so good that it can be guaranteed accurate within 2% on D. C. and 5% on A. C. current. A copper oxide rectifier is built into the meter for A. C. voltage ranges, and a battery is provided for both ohmmeter ranges—a real-self-contained unit.

It is shock-proof in every detail—completely encased in Bakelite. The special test cables are insulated for 5,000 volts — a wide margin of safety. Insulated tips are provided for plugging into jacks. Alligator clips with rubber insulating sleeves as illustrated, provide a safe means for making high voltage connections.

No picture could do justice to its beauty and workmanship. The panel is black Formica with gold characters. A knife-edge pointer gives sharp readings along a handsome silver-etched scale with clear red and black characters. The typical Simpson beauty of design is seen in a glance at the illustration. It is small — measures only 5 1/4 x 2 7/8 x 1 3/4" and weighs only 20 ounces.

### Get on the air—stay on the air—

Here is the instrument that will save many hours during construction and assure basically correct steps—an instrument that will ferret out the trouble. Note the ranges above. See it; examine it—and the Hammeter will become your trouble shooter.

*Order from your jobber*

# SIMPSON

INSTRUMENTS THAT STAY ACCURATE

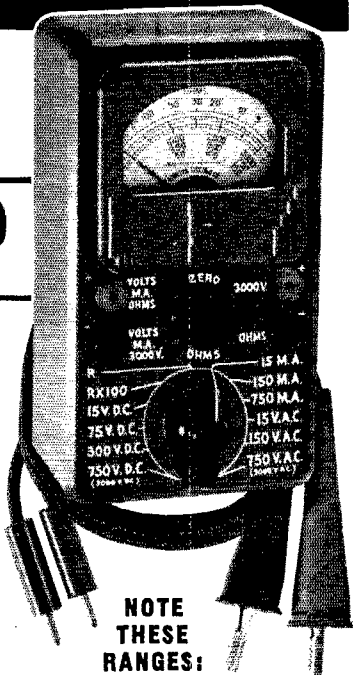

**NOTE THESE RANGES:**

Volts A. C.	Volts D. C.	Milliamperes D. C.
0-15	0-15	0-15
0-150	0-75	0-75
0-750	0-300	0-300
0-3,000	0-750	0-750
	0-3,000	

Ohms: 0-3,000 (center scale 30)  
0-300,000 (center scale 3,000)

Model 240 **\$14.75**  
Your net price —

See Our  
**SENSATIONAL ANNOUNCEMENT**  
on page 80  
New **LOW PRICES** on  
**PANEL INSTRUMENTS**

SIMPSON ELECTRIC CO., 5216-18 W. KINZIE ST., CHICAGO

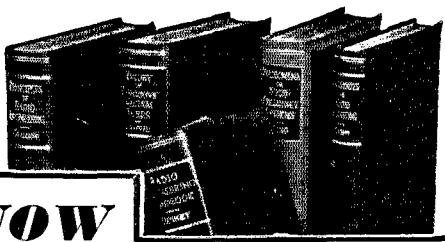

# NOW this high-powered radio engineering library

sent to you for 10 days' trial—  
at a special price and terms

These books cover circuit phenomena, tube theory, networks, measurements, and other subjects—give specialized treatment of all fields of practical design and application. They are books of recognized position in the literature—books you will refer to and be referred to often. If you are a researcher or experimenter—if your interest in radio is deep-set and based on a real desire to go further in this field—you want these books for the help they give in hundreds of problems throughout the whole field of radio engineering.

## RADIO ENGINEERING LIBRARY

—especially selected by radio specialists of McGraw-Hill publications  
—to give most complete, dependable coverage of facts needed by all whose fields are grounded on radio fundamentals

For home-study and reference. Contains a revised selection of books culled from latest McGraw-Hill publications in the radio field.

**5 volumes, 3064 pp., 2000 illustrations**

1. Glasgow's PRINCIPLES OF RADIO ENGINEERING
2. Terman's MEASUREMENTS IN RADIO ENGINEERING
3. Chaffee's THEORY OF THERMIONIC VACUUM TUBES
4. Hund's PHENOMENA IN HIGH-FREQUENCY SYSTEMS
5. Henney's RADIO ENGINEERING HANDBOOK

### Special Low Price and Easy Terms

Bought singly, the five volumes comprising this library would cost you \$25.00. Under this offer you save \$1.50 and, in addition, have the privilege of paying in easy installments beginning with \$2.50, 10 days after receipt of the books, and \$3.00 monthly thereafter. Take advantage of these convenient terms to add them to your library now.

### SEND THIS ON-APPROVAL COUPON McGraw-Hill Book Co., Inc. 330 W. 42nd St., New York, N. Y.

Send me Radio Engineering library, 5 vols., for 10 days' examination on approval. In 10 days I will send \$2.50, plus few cents postage, and \$3.00 monthly till \$23.50 is paid, or return books postpaid. (We pay postage on orders accompanied by remittance of first installment.)

Name.....

Address.....

City and State.....

Position.....

Company..... QST-2-39  
(Books sent on approval in U. S. and Canada only)

(Continued from page 67)

all its advertising as a result, let it go and be hanged to it. Has any reader a better suggestion?

— G. S. Light, ex-VE3AW

**Ebbron's Note.**— We don't think there is room for worry about abandoning the code test. In the first place the international treaties (Madrid, Cairo, etc.) absolutely require it before amateur licenses are issued, regardless of an individual government's possible attitude. The A.R.R.L. stands for code tests, a few years ago got the minimum raised from 10 to 13 w.p.m. Moreover, in North America at least, government support of amateur radio is largely based on expertness in telegraphy. True, there has been some talk of a u.h.f. band on which code knowledge wouldn't be required, but this was for the deliberate purpose of disassociating bootlegging and public-utilitarian inclinations from amateur radio—and that move flopped completely, too.

## RSTC

64 Marshall St., Fitchburg, Mass.

Editor, QST:

Considerable interest seems to have been aroused by the comparison of "C" report suggested by W1JPE in his DX column some months ago. Such a report undeniably has merit. But why confine its use to DX contacts only? The present RST system, while perhaps the best that can be devised for general use, falls down when it comes to telling us how our signals stack up with others on the band. Why not, therefore, tack on the "C" and use it for all contacts, both domestic and foreign? RSTC rolls off the key or bug quite painlessly. Try it!

A nine-point scale seems to be rather cumbersome and unnecessary. A five-point scale such as the following would do the trick quite nicely:

- "C" 1—much weaker than average
- 2—weaker than average
- 3—average
- 4—stronger than average
- 5—much stronger than average

This scale is easily memorized, simple, and serves the purpose.

Why not give RSTC a try, gang? Wouldn't you like to know how your sigs compare with the rest of 'em? Yours for an RSTC 599x5 signal! — E. W. Hill, W1JXN

## THE BATTLE AHEAD

Battams Rd., Payneham, South, Australia

Editor, QST:

For many months I have been listening to rumors from more or less reliable sources regarding the outcome of the forthcoming Rome conference in regard to our amateur frequencies. The digest of these rumors can only mean one thing unless something is done immediately, and that is the writing of "Finis" to the pages of amateur radio in many countries.

In these days when nations are apparently arming against each other, what better token of ham radio could be put forward than the hams of all nations arming themselves against a common menace—the loss of their hobby and ability to serve their country and humanity?

In the past A.R.R.L., R.S.G.B. and a very few others have taken up the sword in defense of their amateur frequencies.

Looking at the thing logically, what can be expected when the ever-growing demands of the commercial are met with numerically weak opposition, however hard and enthusiastically the above societies may defend their case?

I would suggest that each country be ably represented at the forthcoming conference by a council capable of putting arguments as they should be put, not a body of hams but a lawyer trained in all the technicalities of argument.

I have approached a good percentage of hams in my district and have put the following suggestion to them:

That each licensed ham desirous of continuing as such should contribute a voluntary fee of five to ten shillings per year (one to two dollars). This would provide adequate funds for each country to be fully represented at the forthcoming convention.

Periodically we are called upon to elect a body of men to represent us in our various parliaments. How often have you approached these men to air any of your own views?



9.7- 555 METERS

# High Performance ON ALL BANDS

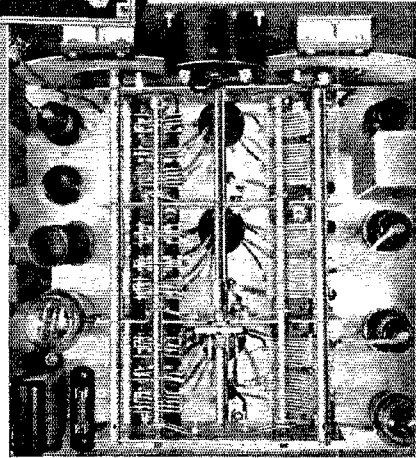
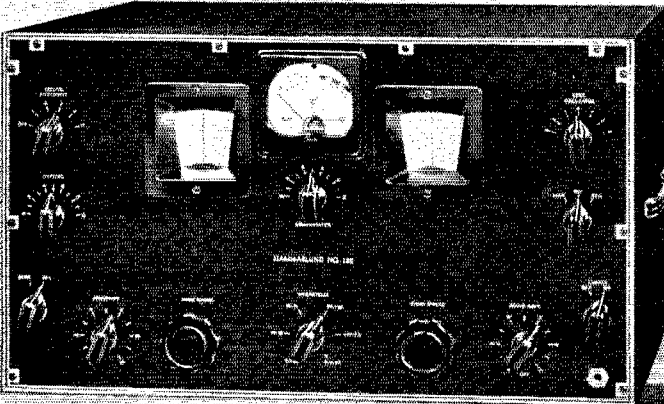

THE NEW "HQ-120" amateur communications receiver has been designed from the standpoint of obtaining peak performance on *all* bands. Special circuit arrangement and tuning condenser construction has made it possible to maintain practically uniform sensitivity throughout all amateur bands. It is no longer necessary to confine your activities to certain bands because of receiver limitations. This high, uniform sensitivity coupled with the new variable crystal filter is a very desirable combination. The bandwidth of the filter can be adjusted to permit full benefit of sensitivity even in the most crowded phone or CW bands. Sensitivity and selectivity must be combined for perfect results. One without the other is useless. In addition, the "HQ-120" has many other outstanding features. The antenna compensator permits perfect circuit alignment, maximum sensitivity and maximum image rejection on all bands with all popular types of antennas. The special 310° band-spread dial calibrated in each of the amateur bands from 80 to 10 meters permits the operator to tell at a glance the frequency of the incoming signal, or that of his

own transmitter. Those who are troubled with automobile ignition interference will welcome the new and efficient noise limiter circuit which limits automobile ignition interference and all similar disturbances. This feature is especially desirable in the 10 and 20 meter bands. The calibrated "S" meter is extremely accurate due to the overall uniform sensitivity of the receiver. It is calibrated in "S" units from 1 to 9 and up to 40 db above "S-9". Ask your jobber to demonstrate the new "HQ-120."

WRITE DEPT. Q-2 FOR 16-PAGE DESCRIPTIVE BOOKLET



**HAMMARLUND MFG. CO., INC.**

424-438 WEST 33rd ST., NEW YORK

CANADIAN OFFICE: 41 WEST AVE., NO., HAMILTON, ONT.



# TALK ABOUT LOSING BANDS!

" . . . To all radio experimenters . . . I hereby direct the immediate closing of all stations . . . I direct that the antennae and all aerial wires be immediately lowered to the ground. . . . "

## SO SMASH GOES HAM RADIO!

That happens at the bottom of page 50 . . . but it's back in full blast by page 59 . . . and this thrilling story doesn't skip a heartbeat in between.

It's the Story of Amateur Radio — TWO HUNDRED METERS AND DOWN — as told by Clint De Soto. This is the book that gives the whole A.R.R.L. story and the whole record of amateur accomplishment.

**BETTER READ IT!** If your library hasn't got it yet, and you can't borrow it from the ham down the street, and you can't get anyone to read it to you over the air — **BETTER BUY IT!**

TWO HUNDRED METERS AND DOWN costs \$2.00 in the regular book binding — only \$1.00 in attractive paper binding. Send your money to the

**AMERICAN  
RADIO RELAY LEAGUE**  
West Hartford, Connecticut

Now is the time each and every one of us have a perfect right to put our complaints to these men and if they find they are up against a body united to a common cause I am sure some good will come of it which will do a lot to pave the way.

I sincerely trust that you will in the interest of amateur radio find room for this letter in your columns as I modestly am of the opinion it should have been done long ago. . . .

— H. V. Bowman, VK5FM

**EDITOR'S NOTE.** — In our opinion, Mr. Bowman touches upon the proper approach to this problem in his third-from-last paragraph. After all, the grass-roots of the problem are the attitudes pursued by the administrations themselves. That is why, for example, the I.A.R.U. is constantly working to improve the relations of its member-societies with their respective governments. We also know that, barring the unthinkable, the government of the U.S.A. will support amateur radio to the fullest and will be followed in that position by the other governments of the Americas and those of most of the democracies of the world. But by the same token it is mighty difficult to make a dictator like what he doesn't want to like, all manner of legal arguing notwithstanding. Although our representations at a conference are of immense importance, it is our considered belief that most of the accomplishment that Mr. Bowman seeks is spade-work that ought to be done by amateur societies in their respective countries during the preparatory years before Rome. For a fuller discussion of this subject, refer to September QST, page 20.

## A. R. R. L. QSL Bureau

(Continued from page 57)

- VE1 — L. J. Fader, VE1FQ, 125 Henry St., Halifax, N. S.
- VE2 — C. W. Skarstedt, VE2DR, 236 Elm Ave., Westmount, P. Q.
- VE3 — Bert Knowles, VE3QB, Lanark, Ont.
- VE4 — George Behrends, VE4RO, 186 Oakdean Blvd., St. James, Winnipeg, Manitoba.
- VE5 — H. R. Hough, VE5HR, 1785 First St., Victoria, B. C.
- K4 — F. McCown, K4RJ, Family Court 7, Santurce, Puerto Rico.
- K5 — Norman F. Miller, K5AF, 15th Air Base Squadron, Albrook Field, Canal Zone.
- K6 — James F. Pa, K6LBH, 1416D Lunalilo St., Honolulu, T. H.
- K7 — Dean Williams, K7ELM, Box 2373, Juneau, Alaska.
- KA — George L. Rickard, KA1GR, P. O. Box 849, Manila, P. I.

## B. C. I. and the Amateur

(Continued from page 59)

telephone Mr. 'Doe' at such and such a number. Your interference problem will receive prompt attention." You should not say, "I will fix your radio, etc."

If this is done, as well as Rule No. 2, the cases where the "boiling point" has been reached will be greatly reduced or completely eliminated. Take it from one who has had several "boiling point" cases—it is very much to the amateur's advantage, in the long run, to prevent them. It has been truly said, "An ounce of prevention is worth a pound of cure."

The suggested procedure will not only be to the amateur's personal advantage—possibly even saving him from legal troubles—but it will be to the lasting advantage of amateur radio in general.



## THE JOHNSON "Q" ANTENNA SYSTEM

This highly efficient system is applicable to a wide variety of antennas, including the sensational "Q" Beam (*QST*, September 1938), Radiator-Reflector and Radiator-Director Beams, Harmonic Radiators, "V" Beams and many others. With all these the following advantages are realized:

### ADVANTAGES OF THE "Q" ANTENNA SYSTEM

1. Greater radiation from the same transmitter power than may be obtained with ordinary non-matched antenna feeder systems.
2. Matched impedances throughout.
3. Permits use of open wire line resulting in exceptionally low transmission line loss — about  $\frac{1}{10}$  that of "twisted pair" lines.
4. No exact or critical overall line lengths. Line may be several hundred feet long if desired.
5. Permanent low-loss construction. Glazed porcelain insulation — no weathering.
6. Easily installed and adjusted — complete data supplied.

Ask your jobber or write for Antenna Bulletin 105J describing the many applications of the "Q."

Export Address: 25 Warren Street  
New York, New York

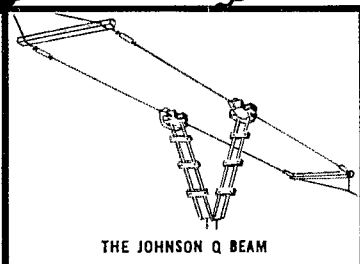

THE JOHNSON Q BEAM

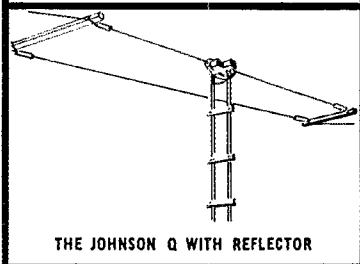

THE JOHNSON Q WITH REFLECTOR

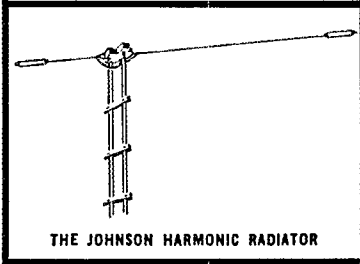

THE JOHNSON HARMONIC RADIATOR



# E. F. JOHNSON CO.

WASECA, MINNESOTA

MANUFACTURERS OF RADIO TRANSMITTING EQUIPMENT

## Simple Vertical Antennas

(Continued from page 49)

directly to the output coil of the transmitter. This is not to be taken as implying that the lower end of the antenna system should be connected to an antenna pick-up coil at a transmitter several feet from the base of the antenna, since such an arrangement would not result in most effective operation. Consequently, if the transmitter is far removed from the bottom of the vertical antenna and the ground connection directly beneath, the antenna coupling tank coil should be provided with a twisted-pair of concentric lines connected across two or three turns of the coil. The opposite end of the line should be connected across a 2- or 3-turn link pick-up coil coupled to the output tank of the transmitter, where the transmitter loading may be adjusted by changing the position of the pick-up coil.

### A System of Higher Frequencies

The antennas of Fig. 1-A, -B, and -C serve best as antennas for the 160- and 80-meter bands, or 80- and 40-meter bands. An excellent two-band vertical antenna for 40- and 20-, or 20- and 10-meter operation, may be constructed as shown in Fig. 3, with the electrical arrangement of Fig. 1-D. Tuned feeders are used to center-feed a half-wave antenna for the lower-frequency band, and the system then acts as two half-waves in phase, or a double-Zepp antenna, for the higher-frequency band. The radiation on the lower band from this antenna thus takes place at a low angle to the earth's surface, and on the higher-frequency band, the confinement to low angles is still closer. This results in a saving of energy which would be radiated upward, and thus wasted, from antennas of other types. Only tuned feeders may be used to couple the antenna to the transmitter.

An inexpensive type of construction which may be used with this antenna is shown in Fig. 3. If the arrangement is to be built for 40- and 20-meter operation, the length of the radiator should be doubled, and 6-inch spaced feeders should be used. The one large drawback to use of this system for 40- and 20-meter operation is the unusual height required — about 75 feet from the ground to the top insulator on the pole. However, a very light supporting pole or mast may be used, since there is no horizontal wire pull at the top. In fact, an extension of ten to twenty feet may be made on a pole already available by splicing on a length of light stock — 1-inch by 2-inch or 2-inch by 2-inch. The overall length of the radiator for 40 and 20 meters may be decreased to 50 feet or less at a small sacrifice in the low-angle directive characteristics. In fact, the 33-foot radiator for 20- and 10-meter operation may be used for 40 meters also if the tuned feeders are longer than 20 feet. If a slightly higher pole is required for the vertical antenna, this disadvantage is readily offset by the fact that only one pole is required, and that light construction, with one set of guys or none at all, is adequate.

If a system with rope halyard and pulleys is

# ATENCIÓN

Tenemos el gusto de anunciar el acontecimiento que consideramos la segunda más importante contribución a la literatura técnica en la lengua castellana, es decir, la traducción de la edición 1939 de nuestro "THE RADIO AMATEUR'S HANDBOOK," por la Revista Telegráfica de Buenos Aires, Argentina, reconocida como la promulgadora de literatura radiográfica más anciana y nombrada de Sud America.

La Edición 1939 del "THE RADIO AMATEUR'S HANDBOOK" representa una revisión completa del manual standard de la comunicación entre aficionados. El capítulo basado sobre la transmisión ha sido amplificado y contiene datos completos sobre la construcción de unidades que se hallan descritas ahora por la primera vez. Los diseños de las unidades facilitan la construcción de transmisores completos de toda potencia. La sección radiotelefónica ha sido redactada de nuevo, con el fin de aumentar su importancia para el aficionado práctico que desea perfeccionar su conocimiento del ajuste y la operación de transmisores telefónicos. Los datos de modulador, (y especialmente con referencia a los sistemas del sesgo de rejilla y de la placa), serán encontrados por cada diseño caracterizado en el capítulo sobre transmisores. El capítulo sobre antenas ha sido amplificado con el fin de facilitar datos completos sobre todas las variedades, desde los tipos más sencillos hasta los aparatos de rayo giratorio más elaborados. El capítulo sobre los puntos cardinales ha sido simplificado. El capítulo sobre la práctica del taller contiene nuevas problemas. Hemos amplificado la sección de receptores por cuatro aparatos, incluyendo los de regeneración sencillos y de súper-heterodino. Unidades de pre-selección y de afinación por antena sencillas, se hallan explicadas, como también material sobre indicadores de afinación y de la potencia de la señal. Las bandas de "u.h.f." no fueron olvidados, puesto que se han construido tanto los receptores y aparatos de transmisión que describimos por la primera vez en esta edición.

Los aparatos portátiles, diseñados y construidos especialmente con este fin, están incluidos en el capítulo sobre equipos de emergencia portátiles. El capítulo sobre instrumentos y medidas contiene aparatos de laboratorio más eficaces y prácticos para el aficionado. Con el ayuda del indicio extensivo el lector puede encontrar con facilidad y prontitud los datos referentes al sujeto que más le interesa.

Siguiendo el plan que habíamos adoptado en la preparación de las ediciones anteriores, es decir, de incluir todos los datos relativos a diseño, construcción y operación de equipos probados, el MANUAL DE 1939 representa el más completo y amplio que jamás hemos publicado. Hoy, más que nunca, representa el valor máximo en la literatura radiográfica.

Se puede conseguir de la A.R.R.L., West Hartford, Conn., EE.UU. a razón de \$1.50 la copia, franco de porte, o si mejor le convenga, directamente de la Revista Telegráfica, Perú 165, Buenos Aires, Argentina, por cinco pesos, moneda de Argentina.

## AMERICAN RADIO RELAY LEAGUE

West Hartford, Conn., U. S. A.

# FOR AMATEUR RADIO

## New—HY40Z—ZERO BIAS

# \$2.75 NET

Zero-Bias Class "B" Modulator, R.F. Power Amplifier, High Efficiency Triode

- Filament Voltage.....7.5 volts
- Filament Current.....2.5 amp.
- Plate Voltage (D.C.)..1000 max. volts
- Plate Current.....115 max. ma.
- Grid Current.....25 max. ma.
- Plate Dissipation.....40 max. watts
- Average Amp. Factor......78
- Mutual Conductance....4400  $\mu$ mhos.

### Inter-Electrode Capacities

- Grid to Plate .....6.3  $\mu$ f
- Grid to Fil. ....5.8  $\mu$ f
- Plate to Fil. ....1.8  $\mu$ f



*Graphite Anode, Lava Insulation, Ceramic Base*

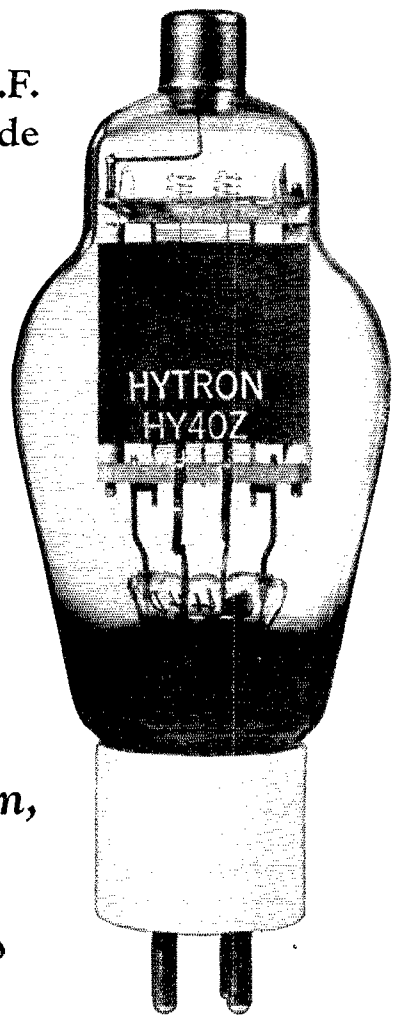

**HYTRONIC**      **LABORATORIES**  
 SALEM                      MASS.  
 A DIVISION OF THE HYTRON CORP.



THE law requires that every amateur station shall regularly check and measure transmitter frequency. Frequency measuring apparatus is required to be external to transmitter frequency control. For precise frequency measurement a stable and dependable frequency meter-monitor is indicated.

GUTHMAN is proud to offer the precision frequency meter and amplified monitor illustrated above and parts for its construction.

This instrument provides features heretofore available only in precision laboratory equipment. Designed for precise measurement, it offers a 7 3/4", 324 degree dial, accurately calibrated for 5 to 160 meter bands; zero adjuster for use with 20 precision calibration frequencies available; A.C. or D.C. operation with voltage and temperature stabilization of electron coupled oscillator and amplified monitoring.

It is styled to "dress up" any station; priced extraordinarily low; designed for precision work.

See your jobber or write for full details on this and an outstanding line of quality r.f. and i.f. transformers, fixed and variable condensers and other parts.

**EDWIN I. Guthman & CO., INC.**  
402 S. PEORIA ST. • CHICAGO, U. S. A.

## PRECISION CRYSTALS

Highest quality crystals carefully prepared for frequency stability and maximum output. Rigidly tested to assure you of dependable operation. Be sure of your transmitter frequency — use PRECISION CRYSTALS.

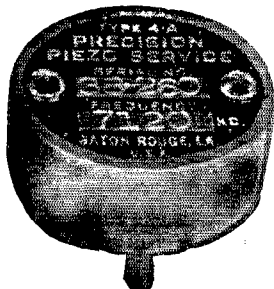

Type 4-A low drift unit plugs into a tube socket. Supplied within 5 Kc. of your specified frequency in the 40, 80 or 160 meter bands. Calibration accurate to within 0.03%. Price, \$4.50.

\*X\* cut crystals supplied in type 4 holder for tube socket within 5 Kc. of your specified frequency in the 40, 80 or 160 meter bands. Price, \$4.00.

Either the low drift crystals or the \*X\* cut type can be supplied in square holders to plug into G.R. type jacks at the above prices.

Crystals for commercial requirements quoted on at your request. Now in our ninth year of business.

### PRECISION PIEZO SERVICE

427 Asia Street

Baton Rouge, La.

preferred, short crossarms may be used at the bottom and top of a pole or mast. Two pulleys should then be used at the top, one at the joint of the pole and top crossarm, and the other at the opposite end of the arm. The halyard may then be run up the pole, through the first pulley, out the arm and through the second pulley, and then attached to the end of the antenna with an ordinary insulator. A short rope or wire with another insulator may be used to hold the bottom end of the antenna to the lower arm, so that the radiator may be held tight.

Aside from the fact that all vertical antennas of the type mentioned are efficient radiators, giving reasonably uniform radiation field strength in all directions around the horizon and giving desirable concentration of radiated energy at low vertical angles, they offer an outstanding advantage of adaptability to small ground space. The 250-foot length of the 160-meter horizontal half-wave antenna, plus additional length for halyards and guy wires, appears tremendous compared to the radius of 15 to 20 feet needed for an efficient vertical 160-meter radiator. And the 66 feet needed for the 40- and 20-meter antenna, if installed horizontally (with consequent highly directional effect on 20 meters, and thus need for careful choice of position) brings out problems often exceeding those of a light type of construction in the vertical direction.

## Book Reviews

(Continued from page 39)

regulations of the Cairo convention are given, along with procedural information of special interest to aeronautical and marine operators. There is also a sample aeronautical operators' examination.

The new "Sterling" marks the tenth anniversary of the appearance of the first edition. Nearly doubled in size, it is an entirely new book, thoroughly up-to-date, combining many types of information usually to be found only in separate volumes.

— G. G.

*The Amateur Radio Handbook*, published by the Incorporated Radio Society of Great Britain. 300 pages, well illustrated. Price, 2/6 (overseas 3/6 or about 87¢).

In the face of restrictions threatening amateur radio abroad, it is a highly encouraging sign to witness the introduction, by the Radio Society of Great Britain, of a handbook for British amateur radio. As stated in the foreword to the volume, "For many years the British amateur was dependent almost entirely upon American publications, for detailed technical information concerning the more generalized aspects of his hobby." Now, the first British Amateur Radio Handbook affords a comprehensive compilation of similar information, as viewed through British eyes.

The project of presenting amateur radio from the British viewpoint has been handled in exceedingly capable fashion under the editorship of J. Clarricoats, G6CL, aided by such well-known technical men and amateurs as VP4TO, G6CJ, G6OT, 2BIB, G5CD, G6GR, G6NF, G6LJ, G6LL, G5JU, BRS648 and G6WY. The resulting treatment is one that intentionally presents information in practical, realistic fashion, rather than from the standpoint of the academician or theorist.

Particularly apparent is this attitude in the sections dealing with fundamentals, where the approach is that of dealing with names and phenomena as they are progressively en-

USE

# C.H.T. TRANSFORMERS

FOR . . .

- APPEARANCE
- PERFORMANCE
- ADAPTABILITY

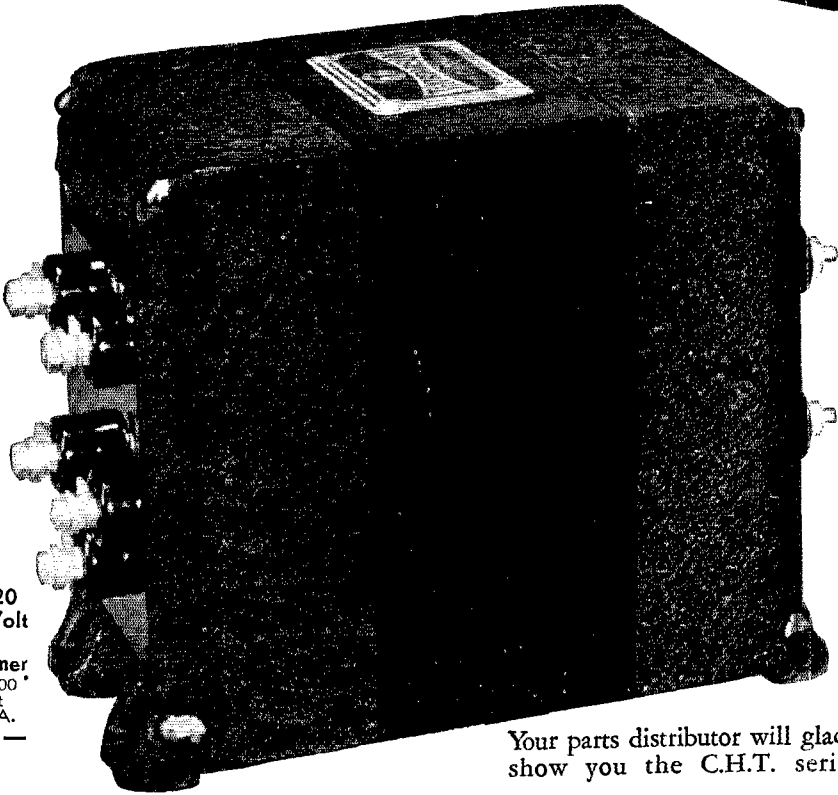
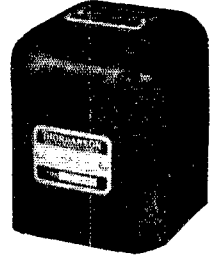

T-15P20  
Multi-Volt  
Plate  
Transformer  
2500-2000\*  
Volts at  
650 M.A.  
Wt. Lbs. —  
140

Your parts distributor will gladly  
show you the C.H.T. series.

**THORDARSON ELECTRIC MFG. CO.**

**500 W. HURON ST., CHICAGO, ILL.**

*Demand "Power by Thordarson"*

# NEW EFFICIENT BANDSWITCH TURRET

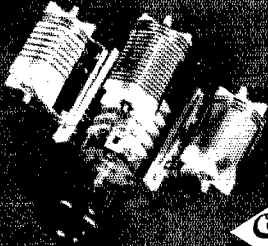

**"PEE-WEE" INDUCTORS**  
and the  
**COTO TYPE 700 BANDSWITCH ASSEMBLY**

Make a new "high" in flexibility, efficiency and compactness. Choose any one of these bands at the flip of the switch. Easily ganged for multi-stage control.

CONSERVATIVELY RATED at 50 Watts 1000 V. Insulation  
SEE THEM AT YOUR JOBBER or WRITE FOR BULLETIN

**RADIO PRODUCTS**  
PROVIDENCE R. I., U. S. A.



countered, rather than by an outline of abstract theory. On the other hand, the apparatus and methods chapters deal more with principles and general practices than with actual constructional data, as has become the American custom. This spirit of calling upon the reader to seek deeper than the superficial, constructional characteristics, making him acquire the basic knowledge necessary to design his own equipment in detail, rather than copy "standard" designs, undoubtedly characterizes the difference in approach of the British ham, who is primarily licensed as an experimenter, and the American amateur, whose chief interest usually is operating.

Some lack of variety in constructional material can necessarily be laid to the somewhat more limited sources of supply of British amateurs, for in general only British-made parts are used. In the "valve" chapter, for example, a page suffices to list the characteristics of the more popular transmitting types. Receiving types are similarly limited. Yet it must be said that these selections do cover the field of desirable vacuum-tubes with surprising adequacy.

The receiver chapter is largely a discussion of principles, a composite basic circuit diagram of a 10-valve receiver serving as an illustrative basis. Representative types of transmitters are shown, the 10-watt British power limit being discernible. For special licensees, 50-watt and 100-watt multi-band units are described briefly. Probably the most exceptional treatment in the volume is that concerned with antenna systems, it occupying by some margin the largest chapter. At first glance it appears that a number of new types are presented, but on examination it appears that only the names are unfamiliar. The British habit of assigning personal names to all developments (as the "Heavyside" and "Appleton" layers for the "E" and "F" ionosphere layers) is well exemplified in this chapter. The bulk of the antenna discussion is concerned with detailed, practical adjustments of the simpler types; directive systems are treated more briefly, the emphasis being on the more compact beams.

A number of chapter headings unfamiliar to American eyes appear. There is the one on "Artificial Aerials" — dummy antennas to you! — for neophyte licensees with 3-letter calls. There is the television chapter, with an informative general summary. There is the "Calculation of Great Circle Distances" chapter, which is practically a trigonometric course in itself. There are separate chapters on "Reference Books," "Data and Formulae" and "Charts and Abacs."

All in all, the G's have definitely got something. They have a comprehensive handbook in a style which should be just to their liking, showing British methods of working with British products, and the R.S.G.B. should find itself in a very short time with an outstanding success on its hands.  
—C. B. D.

## READ AND SEND CODE

Learn Easily at Home this Quicker Way:

No experience needed. Beginners read code quickly, copy accurately. If already an op, speed up your wpm this *approved* way. "Almost human!" experts call the amazing New All Electric Master Teleplex. Only instrument ever produced which records your sending in visible dots and dashes on specially prepared paper tape — then *sends back* your own key work at any speed you wish. Fascinating, fool-proof, gets results because you learn by HEARING as well as seeing. That



is why thousands agree this method is surest and quickest. We furnish Complete Course, lend you the New Master Teleplex, and give you personal instruction with a MONEY-BACK GUARANTEE. Low cost, easy terms. Write today for folder Q2; no obligation.

The "Ham" Standard Teleplex — a highly efficient code teacher using heavy specially prepared waxed paper tape, having two rows of perforations. Write for Free folder Q2.

We are the Originators of this type instrument

**TELEPLEX CO.** 67-69 PARK PLACE  
NEW YORK, N. Y.  
In Canada write: CANADIAN ELECTRONIC INST., TORONTO, ONT.

## W9UA-W9BSP

(Continued from page 32)

weather. A headphone and crystal are used to monitor the voice quality and to give a rough indication of frequency. An Omnigraph and Signagraph are used for code practice work in conjunction with an audio howler consisting of a microphone and headphone. The receiver is a Super-Skyrider SX9.

The antenna is a 246-foot Zepp system supported by two steel windmill towers. The one near the station end is 80 feet high while the other is 100 feet high. Since the antenna is located near Bonita, the highest point in eastern Kansas, signals are given a good start.

Each season the code course is varied somewhat. The last course started with a review of the alphabet, numerals and punctuation marks. This was followed by slow hand-sending of a copy taken from *The Radio Amateur's Handbook* and *The Radio Amateur's License Manual*, after which a discussion of good practice in sending and re-





# 4 "MUSTS" for your next RECEIVER

New . . .

## HOWARD

Model 438

**4 BANDS—8 TUBES  
BUILT-IN SPEAKER**

1. CRYSTAL FILTER
2. ELECTRIC BAND SPREAD
3. R.F. ON ALL BANDS
4. CERAMIC COIL FORMS

All Contained in Model 438

Only  
**\$49<sup>95</sup>**  
Less Crystal

With the advent of the world famous 430, many have asked for a larger receiver—here it is.

Model 438 embodies professional features never before associated with equipment in this price class . . . real "DX" with R-9 reception: Ceramic Coil Forms . . . R.F. Stage on all Bands . . . Separate Coils for each Band . . . Xtal Filter . . . Complete Coverage 540 KC—43 MC . . . Electric Band Spread with vernier

control . . . 2-stage Iron Core I.F. . . . Accurately Calibrated Slide Rule Dial . . . 8 Tubes . . . Provision for a 6-volt Power Supply . . . Band-in-use Indicator . . . B.F.O. with Pitch Control . . . 2 Watts Power Output . . . Built-in 6" Dynamic Speaker . . . Head Phone Jack . . . Doublet or Marconi Antennae Connections . . . Provision for External Speaker . . . Provisions for Howard tube type 'R' Meter.

### Models to Suit the Individual Tastes of the Most Exacting Amateur and Professional

**MODEL 450-A**—12 Tubes—6 Bands—Frequency Coverage .54 to 65 MC . . . Ceramic Coil Forms . . . Dual I.F. Channels . . . Two S.L.F. Ceramic Insulated Tuning Condensers . . . 47 inches of electric bandspread . . . Crystal Filter . . . Calibrated 'R' Meter . . . Accurately calibrated direct reading dial . . . Price, with Tubes, less Speaker, less Crystal . . . . . **\$87.50 Net**

**MODEL 430**—6 Tubes—4 Bands—Frequency Coverage .54 to 40 MC . . . Ceramic Coil forms . . . B.F.O. with pitch control . . . Iron Core I.F. transformers . . . Electric bandspread . . . Built-in Dynamic Speaker . . . Headphone jack . . . Accurate direct reading straight line dial . . . Price, Complete with Tubes and Speaker. . . . . **\$29.95 Net**

**MODEL 440**—9 Tubes—5 Bands—Continuous coverage .54 MC to 40 MC . . . Ceramic Coil Forms . . . S.L.F. Ceramic Insulated Tuning Condensers, Electric bandspread, R.F. on all bands, Iron Core I.F. transformers . . . Electric bandspread . . . Calibrated 'R' Meter, Crystal Filter . . . Price with tubes, less Speaker, less Crystal . . . . . **\$66.50**  
Pacific Coast and Export Prices Slightly Higher

Howard Radio Company  
1731-35 West Belmont Ave., Chicago, Ill.  
Please send me more information on  
\_\_\_\_\_ Model 438 \_\_\_\_\_ Model 430  
\_\_\_\_\_ Model 450-A \_\_\_\_\_ Model 440  
Cable Address: "Howardco"  
Name \_\_\_\_\_  
Address \_\_\_\_\_  
City \_\_\_\_\_ State \_\_\_\_\_

*America's Oldest Radio Manufacturer*

# IN THE INTEREST OF SAFETY

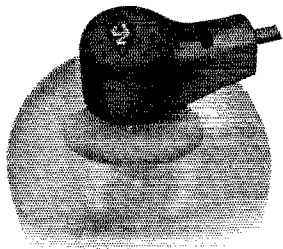

## A NEW INSULATED NATIONAL GRID-GRIP

The new National insulated Grid-Grip reduces the hazard of accidental contact with the plate lead of 866's and similar high voltage rectifiers. Molded of R-39, its low losses also make it suitable for use with high voltage transmitting tubes, such as the 806. Net Price.....\$**.21**

**NATIONAL COMPANY, INC., Malden, Mass.**

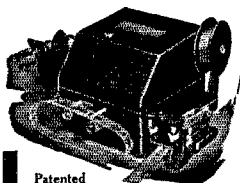

Patented

**\$12.50**

\$13.50  
West of  
Denver

Postpaid  
in U. S. A.

## At Last! A Perfected AUTOMATIC SENDER

Save your fist. Let the Automatic Sender raise your stations for you. Repeats calls or messages indefinitely. Length of messages practically unlimited. Sends from 2 to 70 words a minute. Motor driven. Entirely automatic. Built-in tape perforator. Absolute uniformity in spacing of characters. Used with buzzer or oscillator, makes excellent code teacher for novice and speed-builder for the advanced amateur. Complete with 6 rolls of tape and full instructions. No extra equipment needed.

FULLY GUARANTEED

## Eliminate KEY CLICKS without Loss of Power

Gardiner-Levering Mercury Vapor Keyer gives perfect keying on all CW transmitters — hand key, "bug," or machine sender — at all speeds, without loss of power output. Practically no voltage drop. Will handle keying of any circuit taking up to 850 volts at 500 milliamperes. Uses only one type 83 mercury vapor tube. Separate filament supply built in unit. Only 4 1/2" long and 3 3/4" wide.

FULLY GUARANTEED

If your dealer can't supply you, write us

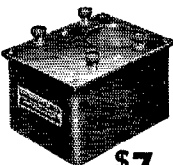

**\$7**

Less tube  
POSTPAID  
IN U. S. A.

**GARDINER-LEVERING CO.** Haddon Heights  
New Jersey, U. S. A.

ceiving took place. Before the completion of the course, all Class-B questions in the *License Manual* were transmitted as well as several sections of the *Handbook*. Suggestions for studying the *License Manual* and *Handbook* were given besides explanations of some of the answers given in the *License Manual*. Next, one tape on the Signagraph was run through and every few minutes the speed was increased, seldom exceeding 10 words per minute. An intermission followed during which questions were answered. Another more difficult tape followed with speed gradually increasing up to 20 words per minute. The average time spent on the air was one hour and fifteen minutes per lesson.

Reports were received from many of those who had only the alphabet memorized when they started with the code lessons but who were able to pass the 13 word-per-minute test at the end of the course.

— D. H. M.

## Philip C. Murray, W9VYU

(Continued from page 31)

stand firmly. As he moved forward he stepped into a small puddle of water that had formed from snow melting on rubbers which had been left on the floor.

Murray slumped and, with the microphone still in his hand, fell against the wall. Johnson immediately disconnected the electricity and called both the fire department and a doctor. Resuscitation attempts were delayed until their arrival. Although, according to Johnson, W9VYU gasped a couple of times after the current was disconnected, the firemen did not succeed in getting any sign of life at any time. Efforts at resuscitation were finally abandoned when the doctor pronounced Murray definitely dead after nearly a half hour's work.

The subsequent examination of the equipment disclosed that the rectifier filament transformer had broken down, establishing a short-circuit between the 5-volt filament wiring (which was at 500 volts positive with respect to the chassis) and the 115-volt primary. The amplifier chassis was not grounded, with the result that there existed a 500-volt potential between actual earth (through the a.c. line and the wet floor) and the microphone stand (connected to the chassis). It was this potential — 500 volts d.c., pulsating 120 times per second — that proved fatal.

W9DOQ summarized the situation fully in saying, "The sad part is that there was not the usual carelessness in connection with this tragedy. How many of us stop to consider that a microphone could be a danger source, as it was in this instance? The microphone lead did not fall across the high tension wire as it was first supposed. The transmitter proper was not even turned on at the time. . . ."

W9VYU was not the sort of person to be careless in dealing with high voltages. Indeed, safety work was one of his great interests, and he had been actively engaged in company safety meet-

HERE'S HOW TO START 1939 RIGHT

with that **NEW RECEIVER** you've always wanted

**National's  
NEW NC 100XA**

Notice the big, new type, illuminated dial with direct reading scales for each band. Calibrated in Megacycles. Also continuous running vernier dial with band spread readings from 0 to 1000 at all frequencies. Equipped with "S" Meter. Cabinet restyled and enlarged. Yet with all these fine improvements the NC 100XA costs no more! Send only \$22.50 with order, pay balance easy terms as listed below. Cash Price \$142.50.

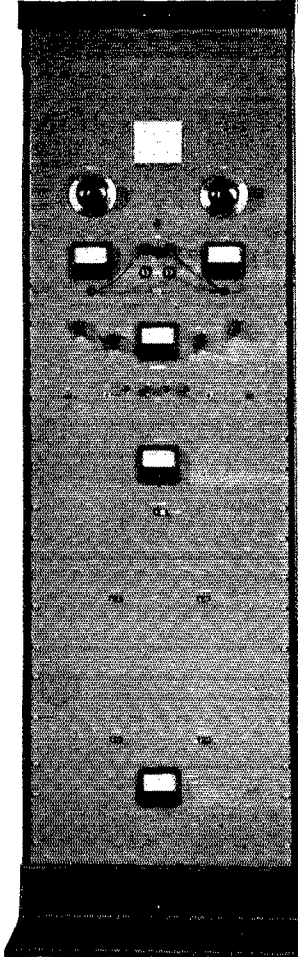
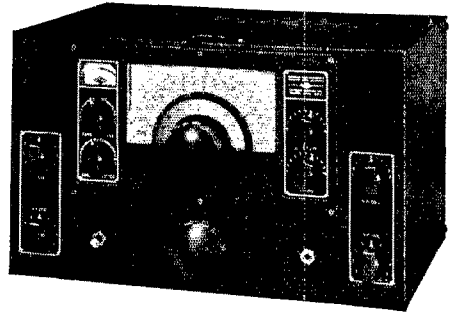

**National's  
NEW 600-WATT  
TRANSMITTER**  
Now Yours on NEWARK'S  
EASY TERMS

Write for Time Payment Details—A modern Transmitter available in kit form built around the new National Co. type "NTE" Combination Exciter and Speech Amplifier. Complete descriptive booklet sent upon request.

**New Foreign Order Dept.**

Special Attention given to FOREIGN ORDERS in this new Export Department. Hams outside the U. S. be sure to WRITE TODAY for Big New Catalog and full details of Newark's New Foreign Order Dept.

**ORDER** Direct from **NOW**  
This Ad

**CHOOSE** any one of the fine nationally known sets you want, just send Down Payment with your order. Balance in what set twelve months as listed below.

	Cash Price	Down Payment	6 Months Payments	9 Months Payments	12 Months Payments
NATIONAL NC 80X-81X Cabinet and Speaker	\$99.00	\$19.00	Complete with Tubes and 8" PM Speaker in		
HALLICRAFTER SKY CHALLENGER II Cabinet	\$19.00	\$14.36	Complete with Tubes, Crystal and Speaker in	\$9.66	\$7.30
NATIONAL NC 100XA Cabinet	\$142.50	\$22.50	Complete with Tubes, Crystal and Speaker in	\$21.10	\$10.80
NATIONAL NC 101X Cabinet	\$129.00	\$24.00	Complete with Tubes, Crystal and Speaker	\$18.58	\$12.50
HAMMARLUND HQ 120 Cabinet	\$179.70	\$29.70	Complete with Tubes, Crystal and Coils	\$17.67	\$13.45
NATIONAL HRO DE LUXE	\$49.50		Complete		
NATIONAL NC 44	\$152.88	\$27.88	Complete		
HALLICRAFTER SKY CHAMPION — Model S-20	\$138.60	\$28.60	Complete with Tubes, Crystal and Speaker	\$19.42	\$13.07
RME 69	\$129.50	\$24.50	Complete with Tubes, Crystal and Speaker	\$18.58	\$12.50
RME 70	\$243.00	\$33.00	Complete with Tubes, Crystal and Speaker	\$36.35	\$24.61
RCA-AGR 111	\$261.00	\$41.00	Complete with Tubes, Crystal and Speaker	\$38.08	\$25.78
HAMMARLUND SUPER PRO	\$29.50	\$23.00	Complete with Tubes and 8" Dynamic Speaker	\$17.74	\$11.93
Model SP 110, 15-560 Meters or Model SP 110S, 7.5-240 Meters	\$123.00	\$34.50	Complete with Tubes and 8" Dynamic Speaker	\$20.26	\$13.64
Model SP 110X, 15-560 Meters or Model SP 110SX, 7.5-240 Meters	\$149.50	\$34.50	Complete with Tubes and 8" Dynamic Speaker	\$20.26	\$13.64
HAMMARLUND SUPER PRO	\$64.50	\$14.50	Complete with Tubes and Speaker	\$9.32	\$6.26
Model SP 110X, 15-560 Meters or Model SP 110SX, 7.5-240 Meters	\$69.50	\$19.50	Complete with Tubes and Speaker	\$9.32	\$6.26
HALLICRAFTER SUPER SKY BUDDY — Model S-19	\$29.50	\$23.00	Complete with Tubes and Speaker	\$17.74	\$11.93
HALLICRAFTER SUPER SKY RIDER SX-16	\$149.50	\$34.50	Complete with Tubes and Speaker	\$20.26	\$13.64
HALLICRAFTER SUPER SKY RIDER MARINE	\$64.50	\$14.50	Complete with Tubes and Speaker	\$9.32	\$6.26
HALLICRAFTER SKY RIDER 5-10	\$69.50	\$19.50	Complete with Tubes and Speaker	\$9.32	\$6.26

**NEW**  
Hammarlund  
HQ-120  
Complete with Tubes, Crystal and Speaker —  
Cash Price  
**\$129.00**  
**\$24 DOWN**  
Balance \$18.68  
for 6 months;  
\$12.50  
for 9 months;  
or \$9.47 for 12 months.

**Oil Filled, Oil Impregnated  
FILTER CONDENSERS**

Only \$1 1500 V. DC. 1 1/2 mfd.

2" Diameter Round Can, 2 3/4" high. Weight 1/2 lb. Well Known Makes. Bought at a lucky price! Quantities limited. First come, first served. Guaranteed at rated voltages.

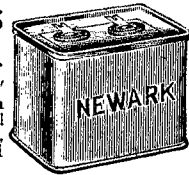

- 2 mfd., 2000 V. DC 4 3/4 x 3 3/4 x 1 3/4, 1 1/2 lbs. .... \$1.50
- 3 mfd., 1250 V. DC 3 3/4 x 3 3/4 x 1 3/4, 1 1/2 lbs. .... 1.25
- 3 mfd., 1500 V. DC 5 x 3 3/4 x 1 3/4, 1 1/2 lbs. .... 1.50
- 4.4 mfd., 1500 V. DC 5 x 3 3/4 x 1 3/4, 1 1/2 lbs. .... 1.75
- 8 mfd., 2000 V. DC 5 x 3 3/4 x 3 3/4, 2 3/4 lbs. .... 2.75

**Your CALL LETTERS  
in GOLD ..... 10c**

Big shadowed decalcomania letters nearly TWO INCHES high. Put them on your HAM SHACK door, auto window, etc. Send dime for yours today. Be sure to give your call letters.

**FREE Catalog**

Listing thousands of items, sets, tubes, parts and supplies. Write for this Big 76 page 1939 Catalog Today.

**NEWARK Electric Company**  
323 W. MADISON ST.  
Dept. Q CHICAGO, ILL.

# ALL 10 ESSENTIAL FEATURES ... in "BABY" AIR INDUCTORS! (25 Watt Rating)

The new B & W BABIES are a worthy addition to a line which includes the popular Swinging Link Assemblies, the unique Band Switching Turret and a wide variety of AIR INDUCTORS famous throughout the world for dependable performance.

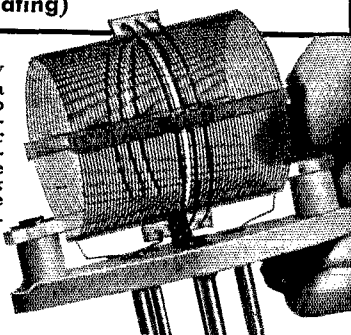

- ★ Smaller Size (1½" x 1¼")
- ★ 5-Prong Alsimag 196 Base
- ★ Conservative Rating
- ★ Less Insulating Material
- ★ Perfect Air-Spacing
- ★ Mechanically Stronger
- ★ Unexcelled Appearance
- ★ Ultra-High Efficiency
- ★ 5 Types (10 to 160 Meters)
- ★ Low Cost . . . \$1.00 Net

See them at your jobber's—or write for details

## BARKER & WILLIAMSON

Radio Manufacturing Engineers • ARDMORE, PENNSYLVANIA

### Your Inquiries Invited

When you need amateur equipment it is to your advantage to write to me. You get personal attention; terms financed by myself so you buy with less cost and more convenience; fair trade-in value for your equipment; ten day trial of all receivers; and my cooperation in every way to see that you are 100% satisfied. No wonder my customers are boosters. You will be too. For the newest equipment, the latest information and technical help, write to W9ARA.

#### Compare My Terms with Others

Model and Receiver	Cash Price	Down Payment	12 Monthly Payments
The new RME-70 . . . . .	\$138.60	\$27.72	\$9.79
The new HQ-120 . . . . .	117.00	23.40	8.36
HQ-120X and NC101X . . . . .	129.00	25.80	9.11
NC100A . . . . .	120.00	24.00	8.48
NC80X and NC81X . . . . .	99.00	19.80	6.99
Bretling 49 and S16 . . . . .	99.00	19.80	6.99
Howard 438 . . . . .	49.95	9.99	3.53
NC-44 and S-20 . . . . .	49.50	9.90	3.49
Sky Buddy with 28 MC . . . . .	29.50	5.90	2.08

Also HRO, Bretling 9, Howards, Sergeants, all others

Similar terms on Hallicrafters, National, Harvey, RCA, RME, Temco transmitters and Thordarson, U.T.C., Utah, Kits.

**Bob Henry**

W9ARA

BUTLER, MISSOURI

ings. He had talked not only on safety in connection with radio work but also on experiences with safety in C.C.C. work, in which he had been engaged for a time.

He was an experienced amateur, and had a well-equipped station. Born in Kansas City, he was 31 years of age at the time of his death. He left no family, having lost his parents at the age of 12, but he was to have been married to Miss Corinne Norlin of Cloquet this coming Spring. He had many close friends among the amateurs and the power men in the vicinity of Duluth and Cloquet.

This account cannot conclude with better words than those of Director of Safety Lounsbury: "If lessons could be learned from his untimely death he would want his amateur friends to benefit from them.

"Are amateurs careful to use high-grade transformers? And I wonder, too, how many amateurs appreciate the importance of insulating their persons from the earth when working on such electrical equipment. Do they, too, all practice resuscitation until the technique of artificial respiration becomes so familiar they can apply it promptly and courageously?"

### Silent Keys

It is with deep regret that we record the passing of these amateurs:

Irving G. Campbell, W2GSI, Passaic, N. J.

Robert S. Connavale, W2KFM, Springfield, L. I., N. Y.

James P. Coyle, Jr., W9YEF, Chicago, Ill.

Charles E. Duncan, Jr., W8FDZ, Barberton, Ohio

Glenn O. Dunn, W8CRP, Detroit, Mich.

Lt. Victor D. Gettys, U.S.N.R., W8EJ, Youngstown, Ohio

Ensign Richard C. Hoyt, U.S.N.R., W2FFL, Mt. Vernon, N. Y.

Edgar Gaylord Hubbel, W1ATW, New Milford, Conn.

A. C. Martineau, ex-Pres. Springfield Radio Assn., Springfield, Mass.

Arnaldo Alves da Motta, PY2LU, Sao Paulo, Brazil

Phil E. Murray, W9VYU, Cloquet, Minn.

Carl O. Noreen, ex-W8CUV, Louisville, Ohio

Sidney E. Pettit, W5FVC, Monroe, La.

Fred H. Provencional, W9HNS, Nopeming, Minn.

Baron Bonaert de la Roche, ON4HM, Harvengt, Belgium

Thomas Traczyk, W8DKB, Dubois, Penna.

Jack Von Tillow, W6DFR, San Francisco, Calif.

Karl E. Weise, W9FZA, Lone Tree, Iowa

Fred L. Wisner, W6ZQ, San Diego, Calif.



## ...8-TUBE TRAFFIC SCOUT COMMUNICATIONS RECEIVER KIT

AS SIMPLE as all that! A screwdriver, a pair of pliers, a soldering iron—and a little ingenuity is all you need to build this 8-tube 5-band TRAFFIC SCOUT.

Assemble the component parts of this remarkable kit on the factory-drilled chassis—connect the parts terminals with hookup wire and you are ready to hear its superb clarity, and to marvel at its excellent performance! You'll say it's a honey of a communications receiver! And everything is included except the tubes and speaker! Detailed wiring instruction sheets are extremely easy to read. Steel panel and cabinet are also available.

Read in the adjoining column a few of the desirable amateur features you get in the 8-tube TRAFFIC SCOUT. You'll see why the TRAFFIC SCOUT is one of the finest buys you can make. See it at your Parts Jobber—or write Dept. Q-2, Mt. Carmel, Ill.

NOTE: Meissner Kits are available from 1 to 14 tubes AC operated, battery operated, etc.

### FEATURES

- 5-band pre-aligned coil assembly for R. F. mixer and oscillator stages.
- Frequency coverage continuous, 9.25 to 565 meters. • "Align-Aire" (Air-tuned) individual coils for each band. • Connections provided for doublet antenna system. • 3-gang precision tuning condenser, ceramic insulated—electrical bandspread condensers on same unit. • Large full-vision dial. 9-inch linear scales—two pointers. Accurately calibrated. • Separate indicator on 0-100 scale for electrical band spread. • Single stage high gain, super-selective Ferrocast (iron core) I. F. channel. • Automatic volume control. • Beat frequency oscillator with pitch control. • R. F. volume control. • Headphone jack, automatically disconnects output stage—volume and tone controls remain operative.

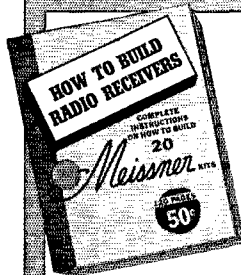

**NEW!**  
**120-PAGE**  
**INSTRUCTION**  
**BOOK!**

Easy-to-understand theory and technical data, graphs, charts, pictorial and schematic diagrams, alignment data, construction data and operating instructions for 20 new Meissner receiver kits. Also information on adapters and converters. At your Parts Jobber—or order direct, addressing Dept. Q-2. Price 50c.

MT. CARMEL, ILLINOIS

"A FAMOUS NAME FOR TWO DECADES"

# Station Activities



## CENTRAL DIVISION

**ILLINOIS**—SCM, Leslie M. Dickson, W9RMN — IHH worked 42 countries in the first month at his new location. ACU has new frequency meter. KJY and RMN made a New Year's resolution not to call CQ during 1939 — O. R. S. and R.M. parties excepted. TZQ is putting his 35T's on 56 Mc. SVZ, a new reporter, has 6L6 with 25-watts input and a 7-tube super. MIN received heard card from AC4YN. UQT is on with a pair of HF100's. AMP made W.A.C. and W.A.S. TFA, The Hamfester's Radio Club, is doing fine traffic work. Ditto for ZXR, The Tower Radio Club at Wheaton College. ARN, Emergency Coordinator for Peoria district, is completely independent of the power lines with a 2-kw. a.c. generator driven by a Whippet-four motor. WEA and UII are on 28-Mc. 'phone. NFL threw away his home-made tape transmitter, when he discovered that it couldn't even send coded groups fast enough to make JZY ask for a QRS.

Traffic: W9NFL 706 (WLTG 25) EBX 443 BEN 205 TUV 183 QKJ 163 YDJ 161 ZXR 154 MCC 125 MRQ 111 TFA 150 DDO 91 HPG 85 (WLTJ 7) KJY 83 (WLTG 190) VEE 76 (WLTG 36) TZQ 62 FOC 36 JZY 21 VS 20 VSK 17 DOH 15 ACU 13 BRY 12 NHF 10 SVZ-DBO 7 HQH 5 CEO-WWP 4 QIZ-BPU 2 IHH 1 RMN (WLTG 24).

**KENTUCKY** — SCM, Darrell A. Downard, W9ARU — The famed KY. QSO parties have started again. See B.G.E.C. for details. CKH can always be heard on 3.9 Mc. Sundays. EDQ says Christmas traffic and power leaks are some combination. THS at Ft. Knox has gobs of spare operators and is, therefore, on consistently. Remember — A.R.T.S. meeting — every second Saturday.

Traffic: W9EDQ 459 ARU 135 CDA 51.

**MICHIGAN** — SCM, Harold C. Bird, W8DPE — Michigan Eights: IXJ is getting back into traffic stride. LU has 200 watter on all bands. DOI is doing nice job on QMN. JAH took part in his first SS. BQA says Mich. Emergency net is under way in fine shape; reports CSX in Jackson for next year. SIS is new reporter from Ionia. QZH is out for O.R.S. GUN's 40 watts get through nicely. AIZ runs nice bunch of schedules in addition to QMN; he is also busy getting his committees together, now that he is E.C. in his town. DPE is still plugging the old QMN. DED has gone on 14-Mc. 'phone. NDL says JYP of Flint was appointed ass't. director for Central Division. CEU is back and building new ham shack. RVE runs nice bunch of schedules. DMP is regular on QMN. SHI, CSG, JZD, OCC, CPY and PLC report by radio. COW is with us again and has fine signal. SNH is new reporter from Port Huron. CMH is doing some rebuilding. PYP is trustee for St. Joseph High School station, which is on 1.75-Mc. 'phone. NGC is to be congratulated on nice work on QMN. NUV, home from school, did a little hamming. SCS sticks with us on QMN even if the DX bug does bite. RJC has been on 7 Mc. FOY says call letter car license plates FB and wants to thank Great Lakes Amateur Radiophone Ass'n. for its efforts in getting them. Michigan Nines: YX has 'O4A final on 3.5 Mc. with 400-watts input; ZHOZ is operating at YX part time. YPI is only ham contact to Isle Royale this winter. CE is playing with DX on 14 Mc. Attention All Michigan Amateurs: If you do not bring your grievances to your S.C.M. how is he going to be able to help you. Hope you all enjoyed a very Joyous Holiday Season. — 73 — Hal.

Traffic: W8QG D 606 W8JZD 261 NGC-RVE 220 FTW 179 (WLTJ 48) AIZ 154 JUQ 147 DYH 123 SH 118 PLC 93 EX 86 DPE 62 NDL 61 KNP 60 SCS 57 DOI 54 CPY 47 DMP 46 SHI 44 PVK 43 LHR 41 GUN 39 PYT 37 BMG 32 IXJ 31AHV 30 COW 28 CSG-CXT 27 ROL-SNH 22 NQI 19 RJC 14 RYP 13 CMH 12 QZH 5 OCC-NUV-DED 6 JAH 4 NXT 3 LU-NQS 1. W9YX 52 YPI 25 CE 7 CWR 5.

**OHIO** — SCM, E. H. Gibbs, W8AQ — Some of the boys really nailed the traffic this month with ISK, CMI, HCS, PIH, RFF, LVU and UW topping the 200 mark. Congrats to 'em! PIH has been doing bang-up job as Regulars net control station. RFF remedied the light-dot trouble with new relay. First word from Gene at UW in long time. 9MYL, 8 took 6 week vacation and had fun with 8-watt 28-Mc. 'phone rig. PGI worked New Guinea. WE moved to Shreve and is very active in QPO (Police Ops) net. NCH, tackle on

Toledo U. football team, got honorable mention for All-Ohio honors. New officers of Toledo U. Radio Club: Pres., IQE; vice-pres., RBR; secy.-treas., NXN; chief opr., OFW. OYI had lots fun in SS. Ohio U.S.N.R. stations are on 3600 kc. Write BAH if interested in U.S.N.R. work. GVX is building complete portable station. SCT has new Sky Buddy. Welcome to BYM, back in O.R.S. ranks and to GAV, Lodi, new O.R.S. and member of Regulars net. LRV returned after another season on Lakes. RN also came back from Lakes and is rebuilding shack. REC is traveling and visiting hams in sunny South. Mount Vernon has gone in for 28 Mc. in big way with LPA, KDU, NPG, OUZ, PGT, PIP and NAF on that band. LEN, Emergency Coordinator for Columbus, resigned due to ill health. OVB has been appointed to take over. The gang wishes Howard a speedy recovery. Ohio River net holds very successful drills every Sunday at 1 p.m. on 3600 kc. PUN is Ohio control station for this net. PRW has new 14-Mc. rig. CUO put up JK beam. PNJ is building new preselector. Cincinnati club is having a QSO contest during January. HFR works 1.8-Mc. c.w. at times and enjoys the wide open spaces there. BDM has rigs perking on all bands, 28 to 1.75 Mc. NID and FSS are new assistant emergency coordinators in Cleveland. AVH has been on 28 Mc. EDR does his rag chewing on 14,212 kc. PKS is building rotary beam mechanism for 28-14-Mc. antenna. PDX built new speech equipment ending with pair of TX40's. CBR intimates gang should worry plenty about feeder losses on 14-28 Mc. BFB is rebuilding and moving rig to first floor. AIR and RRA rang out the old rigs with 7½ hour continuous QSO! MFV has 250-TH crystal osc. and 251A final. RPS ducked BCL trouble by QRP to 15 watts on 1.75 Mc. and works out nicely. GMI has rig on 28, 14, 3.9 and 1.75 Mc. KKH worked PAQQQ on 3.5 Mc. Send in your news and traffic totals, gang, no matter how big or how small, and boost Ohio's position. Those amateurs who QSL'd to KXT in last seven months and received no answer are requested to send another card to new QTH: 14112 Jenne Ave., Cleveland; QSL's sent to old address (Detroit) were destroyed in error.

Traffic: W8ISK 582 CMI 532 HCS 431 PIH 262 RFF 252 LVU 244 UW 215 (WLIH 309) PGI 98 LZE 79 WE 45 EQN 38 MUR 29 AQ 28 LZK 25 NXN 26 LCW 19 OYI 12 BAH 10 GVX-PUN 8 PNJ 6 HFR 5 BYM 4 W9MYL/8 112. (Oct.-Nov.: W8ISK 61 NXN 15.)

**WISCONSIN** — SCM, Aldrich C. Krones, W9UIT — The Milwaukee Club (M.R.A.C.) was fortunate in getting Gerry Sayre, 2QY, to give a talk on his experiences in Greenland with the McGregor Expedition. His interesting talk was supplemented with lantern slides made from photographs taken by himself. NMP is operating 1.75-Mc. 'phone and c.w. RQM made a score of 62, 238 in SS. YXH holds his own in traffic and still works plenty of DX. ZTP, only Milwaukee O.R.S., rolled up a nice SS score. HGF has been active in state net and joined T.L. "A." IYL gets on occasionally. RNX says anyone interested in a really good volume compressor should write him for dope. ZTO is working on portable rig. WDI, WBN and YYZ have class A now. FGU has new QTH and two new 28 Mc. Vee beams. RBI finally hit 75 verifications for Century Club. DIR has gone to Florida for winter. NKT is new Portage ham. HHR has new kw. 'phone. SJD has new rotary beam. ANE is on after absence of three years. Dells Region Radio Club is going to be 100 per cent A.R.R.L. DXI is on 14-Mc. 'phone, 800 watts. KGB is going right along on 1.75-Mc. 'phone. DPR has new YL at his home. HDP is going strong in Wisconsin Net. RJT will be on for sure soon. RZY is on 1.75-Mc. 'phone and about 4:00 a.m. Let's have more reports!

Traffic: W8SZL 120 (WLTG 15) ZTP 204 YXH 103 RQI 7 HGF 61 NMP 2 ONI 16. (Oct.-Nov.: WBAKT 64.)

**INDIANA** — SCM, Noble Burkhardt, W9QG — State C.W. Traffic Net — 6:30 p.m. CST daily on 3656 kc. — call "IN." The Fort Wayne Radio Club is now meeting on the second and fourth Tuesdays of each month. AET is active again. AXH and EKD entertained ZS6AA, who was a visitor from Johannesburg, South Afr ca. EGQ worked three new countries. ESH has new Jr. op — his second boy-FB. GOG is new station at Huntington with 6L6 on 7 Mc. HUV worked his 80th country and made 22,000 points in SS. JYX applied for O.P.S. KBL had swell time in SS. KGD is interested in A.A.R.S. MYL is building a pocket size 28-Mc. transm tter-receiver. NGS still uses low power most of the time. NMO moved to Indianapolis. SWH reported by radio. TRN's new rotary works OK on 14 Mc. VMG was visited twice by 4ACL of Georgia. WCE worked his Asian. YMV

worked 8GWG on 1.75 Mc. at 1:15 P.M. with 1½ watts! ZNC is trying to work some DX on 7 Mc.

Traffic: W9AB 8 DHJ 17 EGQ 23 LDV 40 MYL 112 NGS 20 QG 287 (WLHL 226) SWH 17 TBM 135 VMG 13 XWE 43 ZNC 3.

### ROCKY MOUNTAIN DIVISION

**COLORADO** — SCM, Carl C. Drumeller, W9EHC — Thanks a lot, fellows, for those votes! Keep the reports coming in, and I'll do my best to get them into QST, and to keep up the high standard set by Glen, the retiring SCM. ZDZ heads the traffic list and makes B.P.L. together with EKQ. Swell work! TDS calls attention to the fact that all chapters of the Red Cross are being urged to prepare maps showing locations of all services needed in emergencies, including all amateur radio operators. Let's each one make it his personal duty to see that this information reaches the Red Cross. If you have an Emergency Coordinator, check with him to see that the information has been turned in; if your region has no coordinator, contact the Red Cross yourself . . . then write me, giving your recommendation for the man you'd like to see appointed Emergency Coordinator for your region. Arch and Lucile Haase, GLI and LQO respectively, paid ZCX a visit at the Woodland Park C.C.C. Camp. ESA reports for the Army net. WWB and WZI are pounding them out, down at Pueblo. VVZ got a 350-watt gas-electric generator, but found it unsatisfactory at his 11,000 ft. QTH; so swapped it off and got a 20-watt six-volt job, which does the work nicely. VGC is proud owner of new 8X17. JWC is rebuilding to 76, 6L6, pair RK11's job. NWQ joined the A.A.R.S. ZXU worked VOIT and NY3AA. HDU is having two element rotary beam installed by URW. YYO's new rig uses 6L6G-RK39-808 and pair of 866 Jr's. Nothing unusual about that, BUT . . . he won them all from time to time at various P.P.A.R.A. raffles! YLT has gone back to crystal control. KKY runs 50 watts to a 6L6 osc. on 3.5 Mc. CYM is building new transmitter for 28-Mc. 'phone. CCN bought a crystal that hits the 28-Mc. 'phone band. FXQ works A.A.R.S. 5ESEH is at the Woodman San. and would like a visit from any of the gang. OKY tried out a gas-electric generator at the Black Forest, on a field trip. Now they are back to the good old reliable dynamotors . . . they may require half the storage bats in town to turn them over, but the filament voltage on the 6V6-RK39 doesn't drop to 3 every time the key is punched. LKY has new home location, 731 Swope Ave., and visiting amateurs are invited to drop in and inspect the clubroom, which is a huge trailer. LIU is building new relay rack. LFE has a stack of new equipment to use on 1.75-Mc. 'phone and 3.5-, 7- and 14-Mc. c.w. JVR has been knocking off such DX as J, LU and ZL on 28-Mc. 'phone. KI has a pair of HF200's for his modulator. HHD is still using the T40. ZIZ is rebuilding, with hopes of getting some of that stray r.f. into the antenna. OAR has new 42-T20 rig on 7 and 3.5 Mc. ZCX got a crystal for high end of 28-Mc. 'phone band. EHC has new double-Q beam with an r.f. relay in use on both the transmitter and receiver. He had a visit from OE1PH. TFT is worrying about where he is going to put the guys on his 8JK beam. JAV is wintering in the mountains, far away from power-lines. SWM is working on new transmitting equipment. Ex-9PRF moved to Cheyenne, Wyo., and now has W7 call. TDR and SBB report by radio. JJU reports that a telephone company party held recently in Pueblo turned out to be almost a hamfest. SBB spent the Christmas holidays in Rocky Ford and helped MDN work a little 28-Mc. 'phone. MCB was heard on 3.5 Mc., with a pair of '47's. DSD is having great luck with his four section 8JK beams, one aimed East-West, another North-South, on 14 Mc. WSE changed QTH. WSD is QRL 28 Mc. PTY has all-band exciter finished and is working on the amplifier and keying system. QBI, the N. C. R. Hdq. station for Denver, now has RME9D receiver and pair of 6L6's in transmitter. FA is working Monday night with N.B.C. engineer net, on 3570 and 7140 kc. APR is busy with the police op. net on 3715 kc. BYY is changing QTH. BTO has new 8JK rotary on 14 Mc. EYN has gone loco on vertical antennae, even to putting one 40 ft. above the 7th story of the Denver N.B.C. building. The C.C.R.A. elected ZMH, pres., ZMI, vice-pres., QCI, secy., and RHF, treas. GBQ schedules NBQ and ESA. WJJ reports his beam working FB. QIR is on 14-Mc. c.w. and studying for Class A ticket. LYV knocks off all sorts of DX on 28- and 14-Mc. 'phone. Please, OM's, mail me your reports on the 16th of each month . . . and if you know of anyone who does not report, include some mention of his activities, too. Let's have every active Colorado sta-

tion mentioned in QST every month. 73. — Carl, W9EHC.

Traffic: W9ZXU 10 JWC 2 EKQ 503 ESA 269 LQO 101 WWB 36 WZI 23 GLI 8 TDR 152 (WLJS 36) SBB 28 FXQ 17 ZDZ 738 TDS 48 JJU 29 MDN 18 WJJ 11 QIR 1.

**UTAH-WYOMING** — SCM, Ernest E. Parshall, W7CLG — 6LLH, Utah R.M. 7GEE, Wyoming R.M. UTAH: At December meeting of Utah Amateur Radio Club of Salt Lake, the new regulations were explained and 6PHW discussed rotating beams. 6FYR is on Trunk Line "B" and says "Use Trunk Line B for fast, efficient service." 6PGH has new e.c. "freak" meter-monitor, which picks up all the local BC stations FB. 6LLH has FB new antenna. The Ogden Amateur Radio Operators Club is progressing rapidly with its study of Radio Physics. 60WV is operating portable at Ruth, Nevada. WYOMING: 7GEE reports from Newcastle, where he will be operating portable for about two months. 7GZG has made application for membership in A.A.R.S. 7GCO has new 28-Mc. vertical antenna. The Utah-Wyoming members and myself wish to take this opportunity to extend Hearty New Year Greetings to all.

Traffic: W6FYR 260 PGH 8 LLH 24 W7GEE 192 GZG 7.

### WEST GULF DIVISION

**NORTHERN TEXAS** — SCM, Lee Hughes, W5DXA — FRE is doing fine job with pair of 35T's in final, 450 input. GJW is working N.C.R. and traffic schedules. CHJ works 1.75-Mc. 'phone and 3.5-Mc. c.w. GTL reported for first time. BKH is our new West Gulf Director. Congrats, Bill. HFN rebuilt; 6L6 — pair 6L6's. GDH is handling some traffic on 7170 kc. AZB traded HRO to CV. ECE has rig for 1.75-3.9 and one for 14-28 Mc., working four schedules. FZJ is active with O.B.S. GKB moved to 14 Mc. and is working DX.

Traffic: W5EOE 524 FRE 381 DXA 226 DNE 216 AUL 210 CDU 174 GJW 102 CEE 45 CHJ 42 GTL 30 BKH-FMZ 17 HFN 15 GDH 8 AZB 7.

**OKLAHOMA** — SCM, Carter L. Simpson, W5CEZ — Santa produced a 250TH for the final at CEZ. GFT received Emergency Coördinator appointment. DTU is kept busy making Oklahoma City deliveries. FOM is holding down Oklahoma position on T.L. "D." GFH qualified for A.A.R.S. certificate. FRB completed Navy Training course for Radioman Third Class. FRP/FRW signed up with the Okla. State Net and A.A.R.S. GZU received A.A.R.S. certificate. GVV signed up with A.A.R.S. CEB got A.A.R.S. certificate and enlisted in N.C.R. DAK has tackled Correspondence Course on Naval Regs. EIO hooked up with the C.W. A.A.R.S. Net after having been with the old 'Phone Net. GAQ is enjoying his return to c.w. HAR moved from Beggs to Drumright. FWZ has been elected Convention Manager by Tulsa Amateur Radio Club, and plans are under way for a convention in the spring. BOR led Tulsa entrants in SS Contest. HKE, new ham in Oklahoma City, has 6L6 on the air. AIR visited the S.C.M. GFH received O.R.S. appointment.

Traffic: W5CEZ 553 (HE8C 51) (WLJC 46) GFT 164 DTU 78 FSK 76 YJ 121 (WLJO 71) FOM 61 GFH 59 (WLJE 10) FRB 44 FRP/FRW 43 GZR 36 GZU 35 GVV 27 CEB 26 DAK 25 EMD 23 EIO 3 GAZ 20. (Oct.-Nov.: W5FRB 56 BQA 1.)

**SOUTHERN TEXAS** — SCM, Dave H. Calk, W5BHO — HNB reports for Galveston. FYP works 7 Mc. DIG, the club transmitter, is back on 7 and 14 Mc. after extensive repairs. BEH W.A.C.'d with 6L6 osc. on 7 Mc. ZG and HDY are on 7 and 14 Mc. HNB is working 28-Mc. 'phone with 50 watts. BTK works Storm Net from DIG every Sunday morning. BVF moved to Eastland. FZD worked 33 hours in the SS. GNY reports Sabine Radio Club building three new emergency power units, using Dodge generators. GST rebuilt his rig and works 1.75 through 28 Mc. with 100 watts to T40. BSF has new Johnson "Q" beam antenna and 101X receiver. FNH and BKZ are experimenting with rotating beams. DSH works 28-Mc. 'phone. TF is on 7 Mc. HOD is new ham in Harlington. EWZ joined the A.A.R.S. MN keeps several daily schedules. DWN keeps two A.A.R.S. schedules daily. GXP and GXV, seniors at St. Mary's Univ., are working lots of 7-Mc. DX. FLA and GGC have been working portable near the Pecos River on 7 Mc. with four watts input to 6F6. HS is on 14 Mc. BRC is on 14-Mc. 'phone. GMT organized a 'phone net on 3.9 Mc. with the following reporting for first drill: GMT, net control station; GGE, alternate control; CFX, assistant control; CIJ, traffic manager; ABQ, program director; AHK, BRW, FBH, GEC, BHO, GST, DYK, FDI, DAS and CXH. The net has selected the name "NEAT NET" (National Emergency

(Continued on page 104)

## Naval Communication Reserve Notes

(Continued from page 46)

news items concerning the activities of the various units are published.

The Naval Communication Reserve of the First Naval District has had a number of opportunities to show what it can do in emergency situations, and in all cases has rendered valuable service to the communities affected. In September, when the hurricane wrought such havoc in New England, not only were emergency radio communications provided where normal facilities were disrupted, but in many cases units were mustered for patrol duty in the areas hardest hit and formed a very welcome adjunct to the over-taxed police in performing rescue work and in the prevention of looting.

The Naval Communication Reserve provides the Communication Officers for the two Aircraft Scouting Squadrons in the District. During the time these squadrons are on duty, opportunity is afforded a limited number of NCR enlisted men for training duty at the Naval Reserve Air Base, Squantum, Mass. October 27th, as a Navy Day demonstration, Reserve Aviation units simulated bombing attacks on Organized Reserve Armories. All communications during the conduct of the exercise were by radio, — handled by Naval Communication Reserve personnel. This was the first such operation, involving all Naval Reserve units, to be conducted, and the results were highly satisfactory.

At the Navy Yard, Boston, NDA, the N.C.R. Master Control Station, operates for the purpose of drilling with NAA at Washington and the other District control stations in the National drills on the first and third Thursday of each month. On alternate weeks it drills with the Section Commanders to provide for District training. The Alternate Control Station for the District, NDR, is located in Portland, Maine. This station takes part in all drills and, in addition, stands by on each drill for emergency operation in case of failure at NDA. In such cases, the alternate station takes over full control for the District.

On the first Thursday of each month throughout the year, the Naval Communication Reserve Commander holds a conference with his staff for discussion of the details of administration and carrying out the District Communication Reserve program. On the third Thursday of each month, instructional meetings are held for the N.C.R. officers for training and instruction in Naval subjects other than communications.

From a skeleton organization of a few men with limited training, the Naval Communication Reserve in the First District has grown in the past ten years to one which is well up at the top when the National standings are compiled. The First Naval District finished in second place in the National Competition last year, losing by a fraction of a point to the Twelfth Naval District.

## MORE FUN WITH CW!

### Learn Code the CANDLER Way!

You double the pleasure you get out of CW when you can read and send *FAST* code! But to develop a smooth, rhythmic fist, and the ability to read fast code without strain just as you read newspaper print, requires proper training, with the correct fundamentals — the kind of training you get from Candler.

If you're having trouble with code, if you're stuck and can't seem to make progress, don't be discouraged! Write Candler — and in a short time you'll find yourself over the "hump" sending and receiving code with the best ops on the air.

Candler teaches you the correct fundamentals and sound consciousness, so that you can copy behind without conscious effort. You'll find yourself making more real progress in a few weeks than you have with months of undirected practice. Send for your *FREE* copy of the Book of Facts! Learn how Candler has trained thousands of fast operators. Candler offers advanced as well as beginners' courses — and they are not expensive. *Write today!*

## CANDLER SYSTEM CO.

Dept. Q-2, Box 331, ASHEVILLE, NO. CAROLINA

British Address: Room 56, Craven House,  
Kingsway, London, W.C.2.

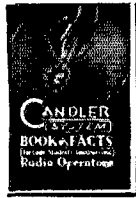

The **DADDY** of  
them all!



Genuine oil-filled high-voltage condensers were mighty scarce — and expensive — before AEROVOX introduced this HYVOL job.

Now many "hams" enjoy dependable, long-life, trouble-free condensers without straining even the leanest pocketbooks.

So be sure to ask your local supplier for AEROVOX 05's. Compare the specs. Compare prices. Ask for catalog — or write us direct, at our new giant plant.





# Easier TO DRIVE

**FULL  
RATED  
INPUT**

"HOW  
MUCH DOES IT  
TAKE TO DRIVE IT?"

— is a commonly discussed subject among amateurs.

Taylor Tubes points with pride to the performance of its superior Buffer-Doubler — Final Amplifier Tube — the new popular TZ-40. This wonder tube can be excited to full rated input directly by any crystal oscillator stage and the output will fully drive a class C amplifier at up to 600-700 watts input. Note the technical data on the TZ-40 doubler stage in the H.F. portion of the DeLuxe Dual Unit 275 watt transmitter shown in the 1939 Taylor Manual. This TZ-40 operating at 350 volts — 60 MA with 7 MA grid current through the 25,000 ohm bias resistor delivers up to 80 MA to the Final Amplifier while doubling from 10 to 5 meters. There is no need for high priced tubes when results like this can be secured so easily. Plan on using a TZ-40 as Buffer or Doubler and save up to \$12.50 in tube cost in this one stage alone. A T-40 or TZ-40 never requires more than 5 watts excitation in any service. Over 10,000 T-40's and TZ-40's in daily service give true testimony to real results.

#### NEW TAYLOR MANUAL READY

It's ready — and your distributor is saving a copy for you. Chock-full of tested technical data and the most modern transmitting circuits. *It's yours for the asking.*

★ ★ ★ ★ ★

THEY'RE COMING SOON !!

A NEW SERIES OF "THIN WALL" CARBON ANODE TUBES WILL BE ANNOUNCED BY TAYLOR IN THE NEAR FUTURE.

WATCH OUR ADS

★ ★ ★ ★ ★

*"More Watts Per Dollar"*

**Taylor** HEAVY **CUSTOM BUILT** DUTY **Tubes**

TAYLOR TUBES, INC., 2341 WABANSIA AVE., CHICAGO, ILLINOIS

*Amateur Net*) and meets every Monday at 6 to 7 P.M. on 3905 kc. It will tie in with the Louisiana Net and the Florida Nets. BNE is working on 28 Mc.

Traffic: W5OW 1721 MN 446 FDR 672 DWN 100 CVQ 91 DLZ 89 FZD 48 GNY 12 GXV 15 GST 2 BHO 10.

NEW MEXICO — SCM, Joseph M. Eldodt, W5CGJ — ENI leads in traffic. HJF at Portales reports for first time. ZM and ZU are both active. Let's have more reports and items of interest, gang.

Traffic: W5ENI 182 ZU 20 HJF 17 ZM 12 (WLJG 6).

### MIDWEST DIVISION

IOWA — SCM, Clyde C. Richelieu, W9ARE — YQY got 1 bug for Christmas. DIB reports passing of FZA. MZM and IXB, 1.75-Mc. boys, are eager for traffic. YZK is on 28-Mc. 'phone. ACF and NDH are on 14-Mc. c.w. ZQW worked ZS6AG on 14 Mc. GPB is working 1.75 Mc. RJE ran up nice score in SS. TMY calibrated frequency measuring equipment; accuracy plus now! WTD has new 100-cc. bar with multi-vibrator, so Burlington now has secondary standard — no more pink tickets, we hope. LAC has new rotary beam and built combination field strength and mod. indicator. QOQ is going high power at Ft. Madison with 41, 6L6, pair RK-11's with 6L6 mod. ALC. on 1.75-Mc. c.w., is working out fine. WMP needs Nevada for W.A.S. QVA needs S.C. for W.A.S. FKA is on 28 Mc. HLY has new 65-ft. tower. AS is getting 89 reports on 3.9-Mc. 'phone with his 25 watts input to pair of '46's. CK is building new 14-Mc. beam. FSH put TZ-40's in modulator. NLA is preparing for Burlington E.C. tests. KYR has nice 1.75-Mc. signal. UOB is on 3.9-Mc. 'phone with nice signal. DSL is on 1.75-Mc. 'phone. AVM is working 1.75-Mc. c.w. It is with deep regret that we report the passing of W9FZA, Karl Weise, Lone Tree, Iowa, on Nov. 19th. Honorary pall bearers at the final rites were DKW, RVE, VRD, FDL, UUC, JZI, NTI and DIB. Iowa has lost an outstanding amateur. WDG, new ham at Fort Madison, plans 1.75-Mc. 'phone rig. ARE is building modulation meter and finishing 14-Mc. rotary beam. NRR is new traffic station. It is with pleasure I announce the appointment of a real old-timer, Les Vennard, W9PJR, as Assistant S.C.M. of this Section. The Burlington E.C. Net is functioning exceptionally well with a strictly emergency-powered QSO party planned for January 14th (9:00 P.M. CST) to January 15th (9:00 P.M. CST). The winning side of the two teams captained by WTD and ARE will be guests of the losers in the Crystal Ball Room of the Hotel Burlington, for quoniam on toast! The All-Iowa Net got under way on the band of frequencies 1763-1767 kc. on January 7th, Saturday, at 7:00 o'clock. Anyone in State of Iowa is eligible to get in on the net fun. Contact TMY for net crystals.

Traffic: W9YQY 3 MZM 4 LXB 3 ZQW 170 ARE 9 NRR 7.

KANSAS — SCM, Melvin D. Kirby, W9UEG — Assistant S.C.M., W9UQX; R.M. — W9ZFS; P.A.M. — W9VRZ. Coffeyville Amateur Radio Club exceeded all expectations in attendance for the hamfest held at Rocky Point Lodge, despite the rain and cold weather. WIN is active on Trunk Lines "H" and "B." YVY reports new Meissner Signal Shifter, including good score in SS contest. AWB has new RME 70. VRZ, our new P.A.M., reports activity on 'phone. CVN has a new Mims signal squitter for 14 Mc. and HRO receiver. NXV is new amateur in Hutchinson.

Traffic: W9UEG 80 WIN 34 ZFS 20. (Oct.-Nov.: W9YOS 76.)

MISSOURI — SCM, Letha Allendorf, W9OUD — The C.M.A.R.C. station ZJK has assembled parts for a new transmitter. The club will also have the use of a 3.5-7-14-Mc. rig, with emergency generator adjustable up to 1 kw., which is being built by the radio section of the N.G. Unit from the replaced air beacon. Twenty are enrolled in the C.M.A.R.C. training class for code and theory, and new members are invited to join. QXO is doing a swell job of traffic handling and is now R.M. for central Missouri. VZQ plans to attend college in Kirksville. KLL is spending the winter in New Mexico. KOH has P.P. T-40's on 1.75-Mc. 'phone and an HT-1 on 28 Mc. SPWU-9 transferred his O.R.S. from New York to Kansas City. ZGS is new O.R.S. there also. EYM is building an e.c.o. JWI got the traffic bug and did FB with his ten watts. DHN's QTH is Warrensburg again instead of Armstrong. UAB is back on with 6L6 crystal osc. KIK is a reliable member of the Section Net. The Mound City Radio

Club donated an A.R.R.L. Handbook in Braille to the Mo. School for the Blind. JAP is back on T.L. "H" and A.A.R.S. work. QCO works regularly in the State Net. NSU is a swell new traffic man. ZVS keeps daily schedules with PYF. YSM and ZVA are regular state netters in the A.A.R.S. group. PYF is doing a grand job as S.N.C.S. SGP is back in Missouri from Tenn. OUD is still using 50 watts for traffic and rag-chews, Mo. Net, T.L. "B," etc. 73, gang, and thanks.

Traffic: W9OUD 525 PYF 188 JWI 175 QXO 115 ZVA 48 ZVS 29 JAP 22 KIK 18 VZQ 10 ZGS-YSM 6.

NEBRASKA — SCM, Samuel C. Wallace, W9FAM — FAM reports that Trunk Line "L" is progressing very FB, and can handle traffic any place. ZAR is keeping a mess of schedules. EHW can QSY any of the four bands in one-half minute. 1.75, 3.5, 7 and 14 Mc. UHT is still looking into a mike once in a while. EKK is on with 200-watt 'phone. ZFC is winding coils for 3.5 Mc. for the net which will be on 3630 kc. FWW has a portable rig; works 1.75- and 3.9-Mc. 'phone besides c.w. on all bands. HVR is very active after quite a spell off the air. ZOO, active in the A.A.R.S., reports old-timer EWO back on hunting DX on 14 Mc. DLK reports for the Southeast Nebraska Radio Club. Things are progressing fine, especially the Emergency Net. JYW is putting up new 72-ft. tower. OWR is building 500-watt portable, 110-volt a.c. generator for emergency work. SUS has a 5-kw. 110-a.c. generator for his station. Dec. 3rd, RUJ received a message on 14 Mc. from 8OQF for Nebraska City; he 'phoned it to DLK operating on 1.75-Mc. 'phone, who gave it to OWR; OWR 'phoned it to JYW, who lives only one block from addressee, and returned answer to DLK via 1.75-Mc. 'phone, who forwarded it by land 'phone to RUJ, who gave reply to 8OQF on 14 Mc. the next day. At the Southeast Nebraska Radio Club regular meeting, Dec. 17th, the club station transmitter was planned. WUD reported into the Emergency Net, Dist. No. 1, via land 'phone to OWR, who in turn put it on the air to ZGX, acting control station, on Dec. 11th. While AFH was in the Mayo Clinic at Rochester, Minn., his condition was reported to the S.E.N.R.C. (of which AFH is a member) daily by ION. Southeast Nebraska Radio Club and friends and relatives were in almost constant touch with him. All join in extending ION sincere thanks for his fine work and cooperation.

Traffic: W9BNT 665 (WLU 386) FAM 386 DI 108 KPA 106 ZAR 45 EHW 41 UHT 37 EKK 35 ZFC 143 FWW 24 HVR 46 ZOO 10.

### DAKOTA DIVISION

NORTH DAKOTA — SCM, Ernest Bloch, W9RZA — ZGR is building new rig for c.w. and 28-Mc. 'phone. WWL is state representative for American Emergency Net and is looking for new members (especially in eastern part of state). Write to him for details. PQW kept daily schedule with SEB to keep him informed of the condition of SEB's sister, who was sick in hospital in Fargo. OEL can be heard on 1.75-Mc. 'phone and 3.5-Mc. c.w. RYZ is putting up antenna poles and planning on 1.75-Mc. 'phone operation. RZA is S.N.C.S.-2 for N.D. C.W. Net. DM has RK-39's working FB. NYD is new call in Fessenden, LEN in Bowbells, NCL in Lisbon.

Traffic: W9RZA 103 WWL 101 DM 35 ZGR 11.  
SOUTH DAKOTA — SCM, A. L. Russell, W9VOD — SEB, R.M. The 1.75-Mc. 'Phone Net is going great guns with TAV, QQQ, GLK, WFL, PVP, JBT, LLG, SIA, ORE, KAN and SGI performing under the leadership of WZH. The gang gets together at 11:30 P.M. CST and, while spot frequency is not used at present, they're in the market for cheap 1904-ke. rocks. Plenty of room for more, say they. SRX is working mostly 'phone. ADJ says to make it seven South Africans and one French station worked in an evening with the new rotary on 14 Mc. ZCC is getting emergency-powered rig going. TI is back on air at Milbank. QNV opened service shop at Hill City. Congrats to FOQ, who knocked down his last one for W.A.C. MYV is new call in Canton; working 3.5 and 7 Mc. ZNM is the latest papa — it's a boy! GEU is sporting a T55 on 3.9-Mc. 'phone. A station activity contest, with prizes and everything, is being sponsored by the Sioux Falls Club. ZRA and RDH are working 1.75-Mc. 'phone. Not satisfied with working 1.75-Mc. 'phone and 3.5-, 7- and 14-Mc. c.w., OGF is trying to get on 28 Mc. LRA will soon be an authority on e.c.o. BKK has a new baby girl, and is rebuilding both receiver and transmitter. RWE rebuilt rig and is working 3.5 Mc. CQK is working mostly 7 Mc., but is hacking at a 3717-ke. rock for use in the A.A.R.S.-O.R.S. Net. VOD got back on with a

6L6, using a clothes line for antenna, v.t., in charge of the Sioux Falls airway stations, gave an interesting talk on his equipment at a club meeting. MRS needs nine more QSL's for W.A.S. VQN built addition to his shack; his new skywire will be 75 feet high! SEB will represent the state in a new midwestern net. TY worked an HHZ. MNO is new call in Rapid City. KNV's new rig with P.P. 6L6's final is going places. YKY is doing OK on 28-Mc. 'phone. ADJ is building new 200-watt modulator using 838's. YOB is taking a shot at 28-Mc. 'phone. SWV moved to Sundance, Wyo., and built a 1.75-Mc. portable 'phone to take along. CJC moved to Denver.

Traffic: W9SEB 210 VQN 83 ZCC 75 FOQ 34 WPA 28 VOD 3.

**NORTHERN MINNESOTA** — SCM, Edwin L. Wicklund, W9IGZ — HEO says his new 101X receiver is tops. LZT gets out FB with 6L6 osc.; he has SX17 receiver. VTH is now in the Navy, stationed at San Pedro, Cal. KQA is pounding brass on 7 Mc. HEN has been appointed R.M. and O.O. He will do most of his checking on 3.5-Mc. band. JID is net control station for Minn. in A.A.R.S. Note his traffic total! CWI, an O.O. who checks on 7 Mc., says there is less off-frequency operation and fewer bad signals. PZU has his 'phone rig working FB. Listen for his A.R.R.L. broadcasts on 3903 kc. at 7 P.M. each Sun. and Wed. AZE has Sky Champion receiver. NYI is new call at Farwell using 6F6 crystal osc. IGZ is using 300-volt vibrator supply plus 250 volts of battery for plate supply. LSC is active on 14- and 3.9-Mc. 'phone. VVA is working nice DX on 14-Mc. 'phone.

Traffic: W9JID 1502 HEN 206 IGZ 9.

**SOUTHERN MINNESOTA** — SCM, Millard L. Bender, W9YNQ — NCS applied for O.R.S. ZAD put a tomato can over the osc. tank and found that such a lowly thing has other uses besides holding tomatoes. SMT is back with us after an absence of a year; he has 802 final. WQF has new T-40 for final. CVH sent a nice lot of news. MZN got out a swell bulletin for his Division. More directors should do this and get acquainted with the wishes of their members. WRR (C.C.C.) joined the MN Net of the A.A.R.S. again; they have two operators on duty at all times. KUI has a 10-tube receiver that works OK. RHT is the only active ham in Albert Lea. UKA moved to Hollandale, Wis. ULN is attending engineering school at U. of M. HCZ is new ham in Albert Lea. On Dec. 18th an unusual QSO took place in which nine stations participated: KEN, LON, WDL, VRY, ZSX, TPZ, GLR, ATP and UPO with YNQ and ZAD operating from WDL. YZW listened in at Ostrander, a distance of eleven miles from Spring Valley, tried to get in on it but couldn't make it, so he "hopped" the family Chev and came over to be in on it. It turned out to be an emergency net drill. All the fellows got a taste of how an emergency net operates. So what started as a rag-chew turned into something that gave them some valuable experience. DCM has so many antennas on that new pole that he spends a lot of time "fooling" around, only to find he has the wrong antenna hitched to the rig. The Minneapolis Radio Club and the St. Paul Radio Club held a joint meeting. Well, fellows, the reports came in swell this month. Anyone, whether an A.R.R.L. member or not, is always welcome to send the news from around his neck of the woods. Your S.C.M. is always glad to hear from every one of you, so shoot it in.

Traffic: W9LCT 80 YNQ 36 NCS 31 DCM 5 GMD 4 ZAD-MZN 2.

#### DELTA DIVISION

**LOUISIANA** — SCM, Eugene H. Treadaway, W5DKR — R.M.'s: 5BN, 5DWW, 5GHF. P.A.M.'s: 5ADJ, 5CXH. E.C.'s: 5DAQ, O.O.'s: 5FFX, 5GDU. DWW has new rig kicking FB. HMV, new Baton Rouge station, has a Utah transmitter working on 7, 14 and 1.75 Mc. HGT is kept active at Louisiana Tech by FVD. DXR received his old call back and is active again. WG visited the boys at Louisiana Tech. GHF is active in Springhill, La., being R.M., O.R.S., O.B.S., and N.C.S. for A.A.R.S. GKJ is putting in a pair of T40's. CXH is working all bands, 56- to 1.75-Mc. 'phone. GUX has a net operating on 1925 kc. ACA is rebuilding exciter unit. EBZ and EAY report active from Boyce. HHH new Kenner station has e.c.o. on 7 Mc. DKR has new signal shifter. AOZ is building high power modulator. FPO will be active again with complete new station. HOA, secy-treas. of N.O.R.C., is getting ready! FSX has new rotary beam. FXK, with 40 watts, is doing nicely. FSI has FB 'phone net on 3905 kc. HCM received heard card from Germany. EBB is acting president of N.O.R.C.

EVS, the activities manager, has the boys swapping away their stations. DXers: HET, KC, GRE, GLH, CEW. DXK sends greetings from Natchez, Miss. BN and FXX were honored by the New Orleans Assn. of Commerce for outstanding traffic work. Congrats, OM's. ECH has T55's on 14 Mc. EVS is proud owner of new HRO. BSR and HHV are active Lake Charles Stations. 90TY is now located in New Orleans. DAQ is doing a great job as Emergency Coordinator. CXQ likes to visit GDU. 5SI, Director Arledge, sends Season's Greetings to the Section. GUK changed QTH to 1125 Caffin Ave., N.O. JW is trying a signal shifter. EDY enjoys those 28-Mc. 'phone chats. FMO and GIA are only active stations in Metairie. AYO is making a study of receivers. FHH is doing a little rebuilding. HHT has plenty power on 1.75-Mc. 'phone. GND is going places with new rig, thanks to CJO. DU, our R.L. is a very active amateur. ADJ likes his new RME receiver FB. BTH is active 1.75-Mc. 'phone. GPS is having good luck with those '10's. Fellows, our Section is full of real active and live wire stations. Please drop your S.C.M. a report on the 16th of each month and watch this report grow. Your suggestions and comments to make this column more interesting are welcome.

Traffic: W5BN 847 FXX 757 DKR 299 FMO 189 GUK 108 AOZ 88 EDY 114 CXQ 17 GDU 29 GIA 6 GLH 5 CXH 15 GKJ 11.

**TENNESSEE** — SCM, W. H. Walker, W4DWS — R.M.'s: 4PL, 4CXY. FFF wants 7-Mc. contacts in the state and with surrounding states. FDT, our E.C. for Memphis, worked VO2AJ on 3.5 Mc.; he has completed emergency rig. Chattanooga news via PL — a new club has been formed, "The Lookout Radio Club," composed of young and ambitious hams, who want club rooms, transmitter and such. The Fort Worth (Tex.) Radio Club, and the Chatta Amateur Radio Club have combined cash, skill, and discounts to build a compact and semi-portable 'phone-c.w. transmitter for Carrol Stegall, ON4CSL/OQ5AW, the African missionary ham from darkest Congo, who is on vacation in this country. Beautifully made by 5ELC, and shipped here, it will be presented to Stegall at a banquet in January, and he will carry it back to Africa. Odd coincidence — the first station worked with it was ZS6HS in Africa! DVK bought himself 10 acres of land out from Chatta and is going into 1.75-Mc. 'phone in a big way with full wave antennas, etc. WZ has started reconstruction. CBA is now copying fast stuff on his mill. DFB and XYL of Nashville entertained 9ARU, S.C.M. of Ky., 4AYE, FLM, DDJ, FQN, BAF and the S.C.M. along with YL's and XYL's at a party. Thanks to Homer and his YF. DLK is our new O.B.S. BAF took emergency rig out into the field and worked into the Nashville Emergency Net with good results. The Nashville Emergency Net is doing fine and is really accomplishing something. New stations answering roll are DKV, DLK and FLM. The N.A.R.C. has been preparing for election of officers and the annual banquet. A Happy New Year to everyone wherever you are!

Traffic: W4PL 1554 CXY 275 FK 261 DEP 168 FDT 160 DWS 152 FFF 58 VK 13 BQK 10 ETD 1.

#### SOUTHEASTERN DIVISION

**ALABAMA** — SCM, James F. Thompson, W4DGS — P.A.M.'s: 4DHI, 4BMM; R.M.'s: 4DS, 4APU; E.C.'s: 4CRG, 4OA, 4ECI; O.O.'s: 4EBZ. Looks like CRG has a strangle hold on the QSO parties. He took the Dec. 4th party with a total of 160 points made by operating on 5 bands. APU was second, DQW third. CRG was 51 points ahead of second place. APU reports for the B'ham Club: ECI, EHH and APU are chasing DX. CUE, the club station had a demonstration of a Hallicrafters Diversity. EHH has an e.c.o. à la Don Mix. ECP reports from Military Academy at West Point. WC is doing plenty well on 3.9-, 14- and 28-Mc. 'phone with indoor antennas. FB is busy with Naval Reserve. EDR got the antenna back up. EBB visited the B'ham Club. EDR is taking T.L. "J" from APU. AAQ has new portable rig at new QTH with 59-46's. ERW has 35T final now. DID has new Signal Shifter and works GN on daily schedule. EBY has 150 watts to T20's on 14314 kc. EJQ reports for Dothan: EUY has nearly completed 500-watt rig. AIZ holds 1.75 Mc. open every night. ETY is headed for W.A.S. on 1.75-Mc. 'phone, using T40 final. EJQ needs Del. for W.A.S. on 28-Mc. 'phone. EDW has new speech amp. for the 28-Mc. rig.

**CORNELL-DUBILIER**

**StarHit** ★ ★ ★ ★ **TYPE TQ**  
**OF THE MONTH**

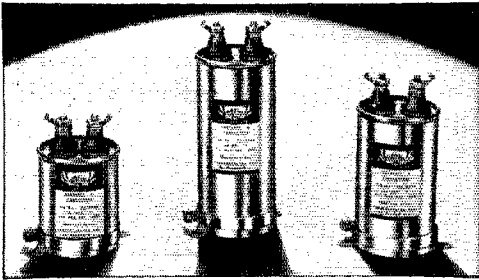

**TYPE TQ X-MITING CAPACITORS**

- 1 — Dykanol (Chlorinated Diphenyl) Impregnated and Filled — Long life; small size; lower power-factor; non-inflammable.
- 2 — Hi-Purity Aluminum Foil — Lower R. F. resistance; light weight.
- 3 — Hi-Purity Multi-Laminated Kraft Tissue — Higher voltage breakdown; minimum leakage; high I. R.
- 4 — Hermetically Sealed — Not affected by moisture, time or temperature up to 200° F.
- 5 — Universal, Steel Mounting Strap — Allows mounting unit in any position.

For a complete listing of the entire CORNELL-DUBILIER line, send for Catalog No. 161, **FREE ON REQUEST.**

MICA • PAPER • DYKANOL • WET AND DRY ELECTROLYTICS

**CORNELL-DUBILIER**  
**ELECTRIC CORPORATION**  
 1013 Hamilton Blvd., So. Plainfield, N. J.  
 Cable Address: "CORDU"

**C-R Tubes in Television Receiver**

(Continued from page 44)

article,<sup>2</sup> using the bar-pattern generator. For the purpose of checking the scanning in the absence of the rest of the receiver, the Kinescope cathode, which normally is connected to the receiver "B" supply, should be grounded. The Kinescope grid is then connected through 0.5 megohm to a bias supply variable from 0 to about 60 volts negative to ground, and the bar-generator signal applied to the grid through a 0.1- $\mu$ fd. blocking condenser. If the rest of the receiver is available, the bar-generator signal may be applied to the grid of the video amplifier tube.

If it should be necessary to modify the vertical scanning beyond the range afforded by the controls marked "vertical distribution" and "vertical peaking," the resistors  $R_{11}$  and  $R_{12}$  and the condenser  $C_{10}$  may be varied. If the horizontal distribution requires modification,  $R_{24}$ ,  $R_{25}$  and  $C_{17}$  may be varied.

<sup>2</sup>J. B. Sherman, "Building Television Receivers with Standard Cathode-Ray Tubes," *QST*, October, 1938.

**What the League Is Doing**

(Continued from page 19)

**CONTROL DEVICES**

SOME amateur concern has been felt that the recent F.C.C. rules legitimatizing the Philco "mystery control" and similar control devices is an entering wedge for some variety of unlicensed communication and that they also offer possibility of interference to our operation. We have made a careful study of this situation at Washington and are convinced there is no room for worry. The rules apply only to control devices; communication circuits will still require license. Permission to use the devices is wholly contingent upon there being no interference to radio communication. We remain fully protected.

**COMMERCIAL OP EXAMS**

THOSE of our members who also have commercial tickets may be interested in knowing that F.C.C. has approved new regulations governing commercial radio operators, to become effective May 1st, as an outgrowth of hearings held before the Chief Engineer last July and September. The present radiotelephone third class license will become known as "restricted radiotelephone operator's permit" and the present radiotelegraph operator third class license will be known as "restricted radiotelegraph operator's permit." The proposed rule dealing with "mental, moral and physical qualifications" of an applicant, which caused considerable comment, was deleted; F.C.C. finds it has all necessary authority in this respect under the Act itself. The 21-year minimum age requirement will apply only to radiotelegraph first class operators. Renewals will be issued as follows: Operators who have had three

**Beams—Verticals—Hi-Q**

Send for **FREE** pamphlet containing 9 beam diagrams, 22 vertical diagrams and the new **Hi-Q Vertical** that does not require insulators. The first publication of its kind — yours for the asking.

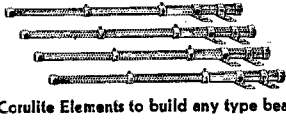
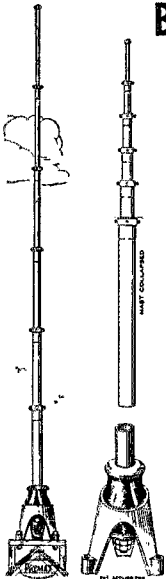

Corulite Elements to build any type beam

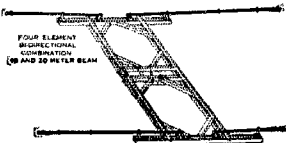

10- and 20-meter Beam Kits, 2, 3, 4 and 6 element types

Vertical Radiators for 10 and 20 meters

**Premax Products**  
 Division of Chisholm-Ryder Co., Inc.  
 3919 HIGHLAND—NIAGARA FALLS, N. Y.

SEND FOR SPECIAL ANTENNA DIAGRAMS

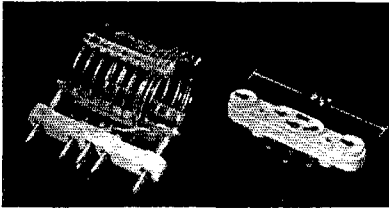
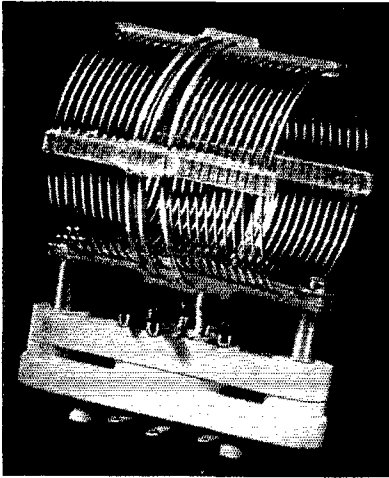

## SMALL PLUG-IN INDUCTORS

Victron insulation, good form factor, and air-spaced bare copper windings give these new coils a high efficiency that makes them ideal for use in buffers, exciters, doublers, and low-power finals. Their compact size (about 1½" diameter and about 1½" length) adapts them to crowded layouts and portables. The Isolantite plug-in base permits quick and easy band changing. They are available for either push-pull or single stages up to 25 watts and for all amateur bands. A blank unglazed Isolantite coil form (1¼" diameter and 2⅜" long) also fits the same mountings. The 5-prong plug-in base and coil-form may be purchased separately.

**NATIONAL COMPANY, INC.**  
Malden, Mass.

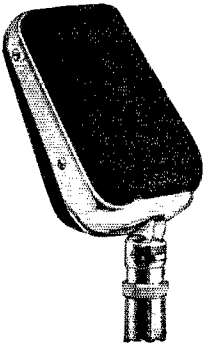

MU-2 & 4



K-2

# ASTATIC

## QUARTET OF CRYSTAL MICROPHONES

Rendering Highly Efficient Service  
in Amateur, Professional and Commercial  
Fields the World Over.



T-3

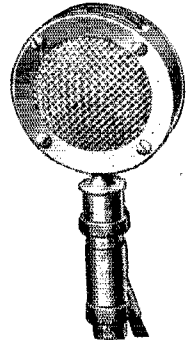

D-104

Improved crystal assemblies. Shock-proof internal mountings. Barometric compensation and moisture-proof treatment of crystals. Appropriate frequency response. New beauty and flexibility of design. Sturdy construction. Quality materials and workmanship. The MU Series and Model T-3 Microphones constructed with unique swivel mount, concealed wires and tilting head. Polished chrome finish. All equipped with interchangeable plug and socket connector and shielded rubber covered cable. List prices follow.

MU-2: \$29.50

MU-4: \$39.50

K-2: \$27.50

T-3: \$25.00

D-104: \$22.50

**See Your Astatic Jobber or Write for Literature**

*Licensed Under Brush Development Co. Patents. Astatic Patents Pending*

**ASTATIC MICROPHONE LABORATORY, Inc. YOUNGSTOWN, O.**  
*Pioneer Manufacturers of Quality Crystal Products*

# Amateurs the World Over Depend on OHMITE

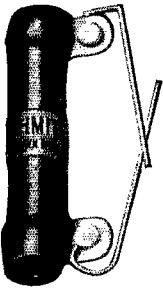

★ Like "tried and true" veterans, these sturdy Ohmite Vitreous-Enamelled Resistors insure continuous trouble-free service in countless amateur and commercial installations the world over. The *Brown Devils* are ideal for voltage dropping, bias units, bleeders, etc. 10 and 20 watt sizes. The *Adjustable Dividohms*, for convenient voltage dividers or for quick accurate change of resistance value. 10 watts to 200 watts. ★ Ask Your Jobber also about the new Ohmite Dummy Antenna.

Write Today for Free Catalog 17

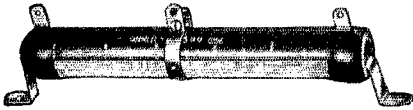

OHMITE MANUFACTURING CO.

4831 Flounoy Street

Chicago, Illinois, U. S. A.

## OHMITE

RHEOSTATS RESISTORS TAP SWITCHES



E. H. Rietzke  
Pres. CREI

## • YOU can be a Radio Engineer

Learn at home—in your spare time

● Just ask "any engineer" what he thinks of CREI training — and you will be convinced that we have the very thing you need to get ahead in radio. The men who are going up into those important jobs are fellows with technical training and engineering ability. The fact that CREI men now hold important jobs in so many broadcasting stations and other fields of radio, is proof that our training pays!

### Men with Technical Training Get better jobs—more money

Right now is the time for you to start training for more money and a better job. CREI offers you a practical, thorough home-study course in Radio Engineering and Television. There's a real future for those who take advantage of it now. Write for details.

More than  
**275**  
Broadcasting  
Stations  
Employ  
CREI Men

TEAR OUT COUPON AND MAIL FOR FREE BOOK

**FREE!** Please send me your new illustrated book, "A Tested Plan for a Future in Radio"

Name.....

Address.....

City.....



Capitol Radio Engineering Institute  
Dept. Q2, 3224 16th St., N.W., Washington, D. C.

years' experience in the aggregate during the five-year license term, or, in lieu thereof, who have had two years' experience of which one year includes the last year of the license term, will be granted renewal licenses without examination. Licensees who have had less than this service but more than three months' service during the last three years of the license term will be given an abridged examination which may be completed in a very short time as compared with the examination for original license. Persons having less than three months' service during the last three years of the term must be examined as for original license.

## Battery-Operated Superhet

(Continued from page 14)

preciable portion of a band, so that frequent adjustment is not required.

If it is found that the band is located too far toward the high-capacity limit of  $C_{13}$ ,  $C_{14}$  should be reduced slightly; if too far toward the maximum limit of  $C_{13}$ , the capacity of  $C_{14}$  should be increased slightly.

### Adjusting for Single-Signal Selectivity

The only adjustment now left is that for single-signal selectivity. With  $R_3$  set near the ground end, replace the insulated wire connected to the grid of the 1N5G as previously described, adjusting its length and position until the stage oscillates. It should be possible to stop oscillation by adjustment of  $R_3$ . With no i.f. oscillation, tune in a moderately strong carrier and then turn the beat oscillator off; tune the signal in as accurately as possible using the signal hum or hiss. Now turn on the beat oscillator and adjust to the desired pitch. Careful adjustment near the point of oscillation should now produce a faint ringing sound indicating high selectivity. If a signal is now tuned in, it should be strong on one side of zero beat and very weak on the other side. Maximum selectivity will not always be required and therefore the regeneration control may be backed off to a point producing moderate selectivity for general listening. It is very advisable, once the receiver is adjusted for the first test band, to spend considerable time getting accustomed to the operation of the receiver before proceeding to other bands.

### Mounting in Cabinet

With the receiver working properly, it may now be mounted in the cabinet. The battery leads should be marked in some manner for identification and holes for the various controls should be spotted in the front panel of the cabinet from accurate measurements taken from the chassis. The template furnished with the National B dial should be used for locating its mounting-screw holes after the shaft hole has been located. Make all holes in the panel slightly oversize to take care of small inaccuracies. Now remove the chassis deck supplied with the cabinet and also the bottom plate and rear side. The mounting nuts for the various controls should be removed temporarily, allowing the controls to hang by their

# PROBLEMS

**PROBLEM:** HOW MANY TURNS ON A 1/2" DIAMETER FORM 1/2" LONG MUST I USE WITH A 25 MMFL CONDENSER TO TUNE TO 4000 KC.?

$$L = \frac{10^8}{(2\pi f)^2 C} \text{ MICROHENRIES}$$

$f = 4 \times 10^6$   
 $C = 25 \times 10^{-8}$

6.28	4
6.28	4
5024	16
1256	
3768	
394384	
16	
23664	
3444	
63104	
25	
315520	
126208	
1577600	

$L = \frac{10^8}{15776} = 63.4 \text{ MICROHENRIES}$

$N = \sqrt{\frac{3A + 9B}{0.2A^2} \times L}$   
 $A = 1.5$   
 $B = 0.5$   
 $L = 63.4$

3	15	+	45	0.5
12	0	+	45	0
07	0	+	15	0
00	0	+	07	50
4634				
07	0	+	15	0
00				
36	63.4			
1266				
1268	135			
65	9	368		
		345		

$N = 35 \text{ TURNS ANS.}$

This Problem Quickly and Easily Solved with Type A Calculator

**EASY**

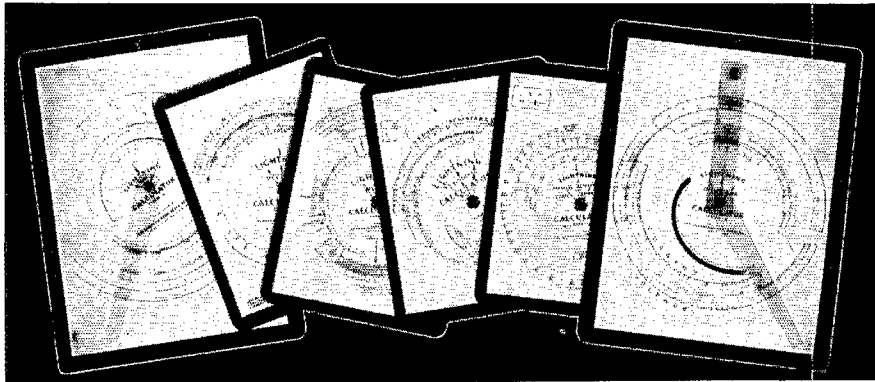

## LIGHTNING CALCULATORS

Six Types Solve ALL Problems

**TYPE A** — For problems involving frequency, inductance and capacity, in design of radio frequency circuits. Direct reading answers for size of coils and condensers for any range between 400 kc. and 150 mc. Price, \$1, postpaid.

**TYPE C** — More information on electrical conductors than you could find in a book full of tables. Price, 50c, postpaid.

**TYPE E** — Direct reading total resistance of resistors connected in parallel, and total capacity of condensers connected in series. Price, 50c, postpaid

**TYPE B** — Gives direct reading answers to calculations involving current, resistance, voltage and power with scale for resistance of copper wire and scale for calculating decibel gain or loss. Price, \$1, postpaid.

**TYPE D** — Gives decibel gain or loss when input and output voltages, currents or power are known. Price, 50c, postpaid.

**TYPE F** — Permits measurement of resistance, from 1 ohm to 1 megohm by use of a voltmeter. Makes an ohm-meter of your voltmeter. Price, 50c, postpaid.

AMERICAN RADIO RELAY LEAGUE, INC., West Hartford, Conn.

# FB

## FOR EVERY HAM —This RCA Oscillograph

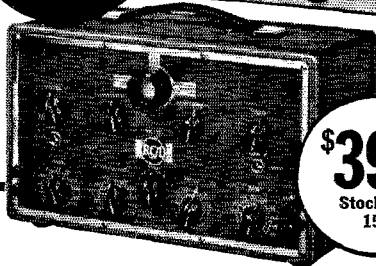

**\$39<sup>95</sup>**

Stock No.  
151

### RCA 1-inch Cathode Ray Oscillograph

Just look at all you can do with this RCA 1-inch oscillograph! You can monitor modulation... check percentage modulation... examine modulated envelope... check distortion in all audio-frequency circuits... examine carrier for presence of key clicks and for hum modulation... check hum in power supply circuits. And remember—not only will this RCA Cathode Ray Oscillograph be a big help to you—but it's very inexpensive, too! See it at your RCA Parts Distributor's.

For finer radio performance — RCA Radio Tubes

Listen to the "Magic Key of RCA" every Sunday, 2 to 5 P. M., E. S. T., on the NBC Blue Network.



## Test Equipment

RCA Manufacturing Co., Inc., Camden, N. J.  
A Service of Radio Corporation of America



# gives you MORE for your money

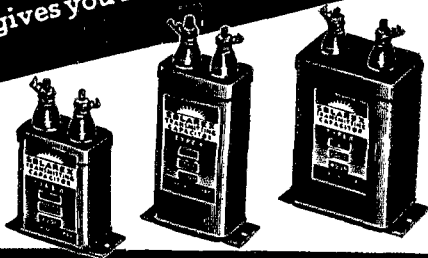

## SOLAREX Oil Impregnated TRANSMITTING CAPACITORS

Catalog upon request

SOLAR MFG. CORP.,  
599-601 BROADWAY, NEW YORK

connecting leads. Place the chassis inside the cabinet and push the control shafts through the proper holes in the panel and start the mounting nuts on the outside of the panel, but do not tighten them. Replace the rear side of the cabinet and then the bottom plate, inserting the front up-turned edge of the bottom plate between the chassis and the front panel. Now tighten up the control mounting nuts, cut off the potentiometer shafts to the correct length with a pair of heavy cutting pliers or a hacksaw, put on the dial and control knobs and the receiver is finished except for placing the batteries in the cabinet and connecting them up.

Space is available for two "A" batteries and the use of two in parallel is advisable since the life of two connected in parallel will be approximately 50 per cent greater than the total life obtainable from two batteries used singly. With operation of the receiver for periods of three to four hours daily, the batteries mentioned previously should last at least three months; with shorter periods of use, much longer. The setting of  $C_{14}$  for each band should be noted in some manner so that it may be set quickly when changing bands.

## 11th DX Competition

(Continued from page 22)

of the club group, at least three reports from c.w. club-member (First Period) participants must be sent to Hq. Similarly a club 'phone winner's certificate will be issued only when three 'phone (Second Period) entries mentioning the club have been received. Reports must be made direct to A.R.R.L., West Hartford, mentioning the name of the club, to be eligible for the affiliated-club-award. Entrants who mention their club will be eligible for both club and Section awards.

The sum of the scores of all club participants ('phone and c.w.) may be added, and reported by the club secretary, to count for the club itself. A genuine gavel, with engraved sterling silver band, is offered as an award to that club whose officers or activities manager submits the greatest collective score in A.R.R.L.'s 11th International DX Competition.

### Rules, Quotas, Etc.

- Contest work must all take place in the contest period.
- Reports must show each time of starting and stopping station operation in the log submitted to A.R.R.L. If the total time of station operation exceeds 90 hours (in either period) the proper factor must be applied to the gross score as shown under "time limit."
- Logs must include date, time of QSO, call of station worked, serial numbers exchanged and other information required, tabulated neatly with the claimed score. (See the log examples for required data.)
- Scoring: Both the W/VE station, and the station in the remote locality receive one point when the W or VE serial number is acknowledged by the station in the remote locality. Each operator similarly, may add two points further when a serial number (to U. S. A./Canada) is acknowledged by a W/VE station.
  - For W/VE entries. In computing points, each "received" serial number group counts 2. Each serial "sent" and properly QSL-ed counts 1.
  - For entries from stations using any prefixes other than W or VE. In computing points, each serial number "received" counts 1 point, and each number "sent" (with proper acknowledgment) counts 2 points.
- Logs must be marked for "phone" or "c.w." transmissions with work in a single entry all by one method for one period. Separate entries may be made for both periods if desired. This is optional.

W/VEs: First Period (C.W.) The quota per country (prefix) may be worked in each different band and is the limit to count points toward the score, except that if one way ex-



# THE SIMPLEST HIGH-FREQUENCY MONITOR



● **FOR Police • Broadcasting • Aeronautical** • Two lamps on relay-rack panel; lamps light when transmitter frequency exceeds tolerance . . . no meters to read; telephone jack for audible frequency check; easy to operate . . . no critical adjustments; monitors up to four channels; ideal for visual monitoring any radiotelephone transmitter operating between 1600 kc and 45 Mc. Price: Type 775-A Frequency-Limit Monitor \$240.00. Quartz Plates \$50.00 per channel.

● WRITE FOR BULLETIN 354 FOR COMPLETE DATA

**GENERAL RADIO COMPANY, CAMBRIDGE, MASS.**

## SS39 SIGNAL SQUIRTERS ARE DOING THE JOB

W1HX says:

Dear Mims:

I am certainly pleased with the new Signal Squirter and as you can see from the list, I have worked all continents in less than three weeks' time since installation. It works wonders for transmitting and receiving. I have had four contacts with Asia on c.w. and on fone I have had R9 plus reports from Europe, Africa, South America and the U. S. A., or Four Continents out of the Six. The power is not doing all that and I feel that the antenna should get all the credit. My installation is only four feet above the peak of the house here and the location is not exceptional although fairly good. Hoping this helps you to know what users of your new antenna are doing, will say best luck and success to you and now I'll sign off.

Cordially yours,  
(signed) NORM YOUNG W1HX

### DIRECTION INDICATOR

Now Ready! . . . \$17.50

Other components available individually. ROTATOR now improved over early model!

20-meter kit . . . . . \$59.50

10-meter kit . . . . . \$49.50

Kit includes low-drain, non-interference producing motors; new coupling system permitting open wire feed; ingenious rotating mechanism; "Inductostub," the new coupling device; self-supporting radiating elements . . . Continuous rotation in either direction, greater transmission gain, easy tuning! WRITE TODAY FOR COMPLETE DATA!

HERE are some of the users of SS39's —

- |       |       |       |
|-------|-------|-------|
| CO2XX | W2JKQ | W6JPW |
| CO7CX | W2JOA | W6MBD |
| G5ML  | W2JSW | W6MXD |
| LU4CZ | W2KAP | W6NKK |
| TK9BA | W2KR  | W6NKP |
| VK2RJ | W3ASG | W6NNR |
| W1AA  | W3BJR | W8AAJ |
| W1AUR | W3CXY | W8ANC |
| W1BGA | W3CZE | W8CIR |
| W1BLO | W3FOP | W8GLY |
| W1BQN | W3FPC | W8HL  |
| W1CND | W4BJZ | W8KDJ |
| W1HX  | W4DSY | W8MPX |
| W1IPC | W4DYP | W8NKY |
| W1JFG | W4FRF | W8ARK |
| W1KIU | W4FT  | W9BHT |
| W1KPP | W5AFG | W5CBJ |
| W1ZD  | W5BDB | W5CVN |
| W2AD  | W5BEK | W5EJC |
| W2ARB | W5DLK | W8NA  |
| W2BTP | W5EKF | W8NFA |
| W2BZ  | W5FHJ | W8NMH |
| W2DQW | W5FPD | W8RFI |
| W2CAU | W5VV  | W8RGH |
| W2GVZ | W5VW  | W8RGV |
| W2HWF | W5ZS  | W8WUC |
| W2HFF | W6BXQ | W9ZBY |
| W2IHX | W6DEP |       |

Get Ready for the DX Contest—Now

"Put Your Signal Where You Want It When You Want It There"

Write—Right Away

**MIMS RADIO COMPANY**  
M. P. MIMS—W5BDB, P. O. Box 504, Texarkana, Ark.

# TO OUR READERS

*who are not*

# A.R.R.L. MEMBERS

WOULDN'T you like to become a member of the American Radio Relay League? We need you in this big organization of radio amateurs, the only amateur association that does things. From your reading of *QST* you have gained a knowledge of the nature of the League and what it does, and you have read its purposes as set forth on page 6 of this issue. We should like to have you become a full-fledged member and add your strength to ours in the things we are undertaking for Amateur Radio. You will have the membership edition of *QST* delivered at your door each month. A convenient application form is printed below — clip it out and mail it today.



*A bona fide interest in amateur radio is the only essential qualification for membership*

**AMERICAN RADIO RELAY LEAGUE  
Hartford, Connecticut, U. S. A.**

I hereby apply for membership in the American Radio Relay League, and enclose \$2.50 (\$3 in foreign countries) in payment of one year's dues, \$1.25 of which is for a subscription to *QST* for the same period. Please begin my subscription with the..... issue. Mail my Certificate of Membership and send *QST* to the following name and address.

.....  
 .....  
 .....

Do you know a friend who is also interested in Amateur Radio, whose name you might give us so we may send him a sample copy of *QST*?

.....

**Thanks**

changes with some of these three have been made, more stations can be worked to give not more than 9 points (basic) per country, per band. This quota shall be permitted in each different band.

The quota depends on the number of qualifying entries submitted from each country in the previous year's competition. With few exceptions it is *three stations per country*. The exceptions: Quota is "4" for those countries where 25-or-more individuals reported and their scores qualified for the official summary of last year's results. *Four stations per country* is the quota for Germany (D), Great Britain (G) and Australia (VK). Note that Tasmania (VK7) is a separate country from the rest of the VK's and for this and all others, the quota of *three* applies.

Second Period ('Phone). No quota limit on stations per country.

6. *W/VEs*: Multiplier shall consist of the number of countries (prefixes) worked on one band plus those worked on a second band, plus those worked on a third band, etc.

7. *All others*: No quota limit on stations.

8. *All others*: Scoring points shall be multiplied (for total) by the number of U. S. A. and Canadian licensing areas contacted (a possible 14). The multiplier is also increased further by working the same areas on *additional frequency bands*. (Example: All districts are worked on two bands, possible multiplier is 28; 10, 8, and 5 licensing areas are worked on three bands. The sum, 23 licensing areas, is the multiplier to use to get the gross score.)

9. All entrants agree to be bound by the Rules and Contest Announcement and the regulations of their licensing authority. In a contest of this magnitude, no correspondence can be entered into regarding Award Committee Decisions.

10. The highest scoring individual operator's score is the *official* score for all awards. Other operator scores must also be submitted separately if more than one operator worked a station. The station score (all points by all countries) may be stated for purposes of comparison, but will not have official significance in making awards.

11. More than one receiver and receiving operator in use at one time to log available DX is not permissible and shall be grounds for disqualification.

12. The same station can be worked in more than one band, provided the quota (per country, per band) which applied in the first period only is not exceeded.

13. Cross band work does not count in this contest.

14. Reports and logs from participating stations must be received at A.R.R.L. Hq. from all W/VE stations on or before noon, April 21, 1939, to be considered for awards. From all outlying localities, reports must be received on or before May 26, 1939. Play safe . . . mail your report immediately at the end of each contest period to avoid delay and insure that your results are credited in *QST*. Show your claimed-score in full, following a tabulation of points in the log-form indicated with this announcement.

15. The entries received after the competition will be passed upon by an A.R.R.L. Award Committee whose decision will be final in all cases.

### Warning!

Good notes, not ragged ones are advisable. The F.C.C. monitoring station personnel are acquainted with the dates of our DX contest, and will be on the job. You do not want to be disqualified! Nor do you wish discrepancy reports for poor notes and overmodulated signals! Better lose out in some operating hours rather than jeopardize your amateur standing. Let's make it a contest with *no bad signals*.

Competitors are requested to submit lists, even if they only show a small score to support claims made in logs from other stations.

### Navy Day

(Continued from page 53)

spective Districts. Hearty congratulations to the letter-winners! As in previous years many participants lowered their standings through carelessness in recopying and through poor guess work when portions were missed. For the Nth time we urge all operators to submit their original copies in activities of this kind. — E. L. B.

(Honor Roll on Page 114)

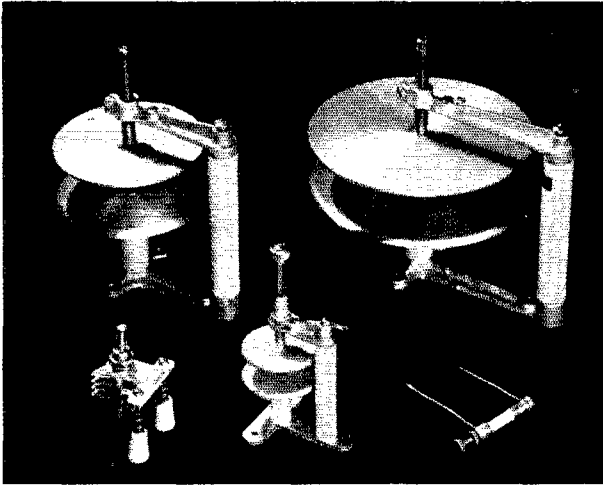

## NEUTRALIZING CONDENSERS

Steady improvements and additions have made National Neutralizing Condensers outstanding in performance and versatility. Recent improvements include micrometer type thimble and clamp for the NC-800 and an insulated mount for the STN. The NC-600 is small and compact enough to be supported by its own pigtail leads and pre-eminently suited to neutralizing 6L6's and the new Gammatron 24's.

In the group illustrated above in the top row, left to right is the NC-150 (Net Price \$3.90) and the NC-500 (Net Price \$7.50). In the lower row, left to right is the new STN (Net Price \$1.20), the new NC-800 (Net Price \$1.80) and the new NC-600 (Net Price \$.27).

**NATIONAL COMPANY, INC. • MALDEN, MASS.**

## ACME VOLTROL . . .

For regulating voltage or testing all electronic functions this new Acme Voltrol offers many advantages. Manually operated. Continuous duty. Complete stepless control from 0 to 130 volts. Panel mounting type illustrated especially adapted for radio work. \$12.00. Write for Free Bulletin.

THE ACME ELECTRIC & MANUFACTURING CO.  
38 Water Street Cuba, N. Y.

## LEARN RADIO — TELEVISION —

500 Licensed graduates placed in past 7 years in shipping, broadcasting, aviation, police, etc.; we also teach radio servicing and repairing; new beginners class now forming, day or eve.; 52-page catalog free; oldest, largest and best equipped.

### MASS. RADIO SCHOOL 18 Boylston Street, Boston

G. R. Entwistle, Pres.  
Established 1899

R. F. Trop, Treas.  
Hancock 8184

## Print Your Own

**QSL** Cards, Stationery, Advertising, labels, paper, circulars, tags, etc.

Save money and time. Sold direct from factory only. Junior outfit

\$8.25. Senior outfits \$17 and up.

Do popular raised printing like engraving with any of our presses.

Print for Others. Big Profits.

Pays for itself in a short time.

Easy rules sent. Write for free catalog of outfits and all details.

Kelsey Presses N-95, Meriden, Conn.



## A GOOD NAME GOES A LONG WAY

Ken-Rad Tubes have a good name because of their long-time dependability and high standards of quality and performance.



# Ken-Rad Radio Tubes

**KEN-RAD TUBE & LAMP CORPORATION - OWENSBORO, KY.**  
Manufacturers of all types of radio tubes and Ken-Rad Electric Lamp Bulbs

Letter Winners

*First Naval District:* W1BE W1BVR W1EZL W1IIC W1JAH W1KPE WILLX W1LOC W1OR. *Third Naval District:* W1AMQ W1GKM W2BCR W2CJX W2CRK W2CYX W2DDV W2DLI W2ESO W2FNV W2GVZ W2HFF W2KCD W2KEZ W2KFB W2KKR W2LLI W2QY W3FAK W3FSI W6OVG/2 W8BSL W8DOD W8EMW W8EWP W8FYF W8NVK W8PSM W8QIR W8SOI Alphonse A. Adamson, C. W. Erickson, Stephen E. Lucia. *Fourth Naval District:* W3AKB W3AOC W3ARK W3EFH W3ETM W3EWF W3EYT W3HNY W3HRS W3QM W8EU W8KN W8KTM W8KTS W8MOT W8NCJ W8OEM W8RHE W8RQ W8SCK Peter F. Long, Pearle Elizabeth Rosenberg. *Fifth Naval District:* W3CMV W3EEN W3GKN W3FNG W3HGV W3HQT W3HUD R. Bradley W3CXL, John D. Lynch, Rocky Smith, Robert T. Wahl. *Sixth Naval District:* W4AAR W4DFC W4DW W4ETE W4EUA W4GY. *Seventh Naval District:* W4AFC W4AGR W4AJJ W4EHZ W4ELT W4EZ W4HC James C. Jackson, D. C. Layman. *Eighth Naval District:* W4ABY W4CED W4DQW W4EX W4RO W5ADZ W5ARS W5AUL W5CEZ W5DAQ W5FAJ W5FJ W5GJW W5RH Robert H. Clearman, G. D. Rayburn. *Ninth Naval District:* W2HHG/9 W8BAH W8BKE W8BKM W8BON W8CHO W8EGX W8LXA W8MQC W8MW5 W8NR W8PO W8PP W8SE W9AKP W9BP W9CB W9DGS W9FQ W9FWS W9FYX W9HDP W9HEZ W9HLX W9KFE W9KTK W9LOH W9NGS W9OEN W9OUR W9PBG W9PNE W9QQA W9RLB W9RSO W9ULQ W9UJW W9WDD W9ZQW. *Eleventh Naval District:* W4DIA/6 W6AFJ W6ALO W6AR W6BHH W6EPZ W6HBD W6HCY W6JD W6MCK W6NYN W6PRK W6QNJ W9YDI/6 J. J. D. Dennis, Frank J. Feery, L. J. Sluyter, R. B. Walling, Raymond A. Wood. *Twelfth Naval District:* W6ADB W6AOA W6BOY W6DHE W6DIY W6ECW W6EJA W6EJU W6ENH W6FCX W6FII W6HGL W6LMZ W6LWD W6NAO W6NTU W6OBK W6PHQ W6PXD W6QJB W6WF W9FA W9GLI W9MDN W9MKN W9SBB M. Ellison, William F. Erdman, Edward Hannah, Jettie Hill, Jr., Homer D. Jagers, Howard K. Smith. *Thirteenth Naval District:* W7APE W7AVT W7BCV W7EWD W7EE W7FPP W7GGW W7GMC W7GPS W7LV W7SJ Leonard H. Harkness. *Fourteenth Naval District:* K6BVL W. K. Harris. *Fifteenth Naval District:* Earl W. Lookwood (NY1AA) Arnold Pincus (NY2AB). *Miscellaneous:* KYFZD VE2AY VE5AGA.

The remaining 432 participants on the Honor Roll follow. They are classified by Naval Districts and are listed under their respective districts in the order of rating. Where calls or names are connected by dashes, it indicates that these participants have equal ratings and are listed in a group, alphabetically and numerically.

*First Naval District:* W1AFP-W1CFH-W1DUJ-W1EOB-W1FSV-W1JKN-W1JYB-W1KGH-W1QR-John E. Vermeiren W1AED-W1APK-W1BPI-W1BE-W1YD-Joaquin Russe-Donald H. Ryder W1FAK-Donald E. Hinds W1AJ-W1BDV-W1EBY W1BEC-W1BK-G-W1CFG-W1LCS-Harold Deschene W1KRN Henry A. Spencer W1BIV. *Third Naval District:* W1AFB-W1DLN-W2AQV-W2BDR-W2CAV-W2CJI-W2DSV-W2DYF-W2FLD-W2HIH-W2HMJ-W2HQG-W2HYD-W2ICX-W2ISJ-W2JCA-W2KOH-W2KTR-W2LLE-W8KXA-Joseph D. Leahy W1EEX-W1KR-B-W1MY-W2CHK-W2GGW-W2GTA-W2GUP-W2JVK-W2PF-W8RRS W1IYB-W2KBB-W2KW-J. W. Ashmore W1KYF-W8AED-W8NUA W1LFS-W2JKY-W2JSS-W2PY-F. W. Stuart (W2SC) W2AUP-W2LOQ W2EWR-W8PCM-J. K. Lennon W2KNR W2CGG-W8JGX-W8NVC J. Clark White W1CEJ W8RKM W2LBI W2AMX-W8FU W2GXK W8ABX W1AEY-Howard J. Dunn W2COG. *Fourth Naval District:* W3CL-W3DGC-W3DIA-W3EBO-W3GQC-W3KF-W8BBJ-W8FUW-W8EBG-W8KD-W8NCC-J. A. McGinty-Griffith Sechler W3ECI-W3EZ-W3FNI-W3FPG-W3GY-W3HJA-W3ID-W3QY-W8AJE-W8OML-W8QBK W3BNY-W3FEG-W3HPN W8QWI-W8RTS W3AAV-W3ABE-W3QNV W8FHG-W8SNZ W3HLZ W8NUG W8HXJ-W8MDB W8MKQ W3DNU W8BLW W3FPR W3HOM. *Fifth Naval District:* W1INI (op W3ELN)-W3FEP-W3HHT-W3HNF-W3HRQ-W8MCL-W8MVF-W8OFE-W8PT-R. J. Kirkwood W3GAD-W8CYV-W8EZR-W8PSR W. D. Hawley W3CAB W3GWM W3FE W9QDK/3. *Sixth Naval District:* W4AGI-

# LOW COST STEEL ANTENNA TOWER

*Used and Endorsed by*  
**FEDERAL, STATE, COUNTY, CITY GOV'TS., FORESTRY, HIGHWAY PATROLS and HAMS everywhere!**

## ONLY 60¢ PER FOOT Complete!

This remarkable low price is possible only because we produce many thousands of these towers each year for use with our Wincharger. Price includes necessary guy wires and tower sections of 10 or 20 ft. lengths with 5 ft. tapered stub top.

### LIGHT, STURDY, RIGID

Thousands in use as vertical radiators and horizontal antenna supports. Scientifically braced. No points of undue strain. Both vertical angles and cross braces now hot dip galvanized.

### SAFELY ERECTS TO 200 FT.

Quickly and easily erected, without skilled assistance, to heights of from 25 ft. to 200 ft. Enthusiastically used and recommended by police and broadcasters for thoroughly satisfactory service.

### READ U. S. FORESTRY LETTER!

"Your tower was installed on Signal Peak, a Lookout Station on the Yakima Indian Reservation, at an elevation of 5,111 ft. above sea level. We have found the Wincharger tower 100% satisfactory and it has stood up under 70 mile winds, snow and ice which are severe at almost a mile up from sea level." Thomas L. Carter, Forest Supervisor, Office of Indian Affairs, U. S. Department of the Interior, Toppenish, Wash.

**Order Direct From WINCHARGER CORPORATION**  
 Sioux City, Iowa

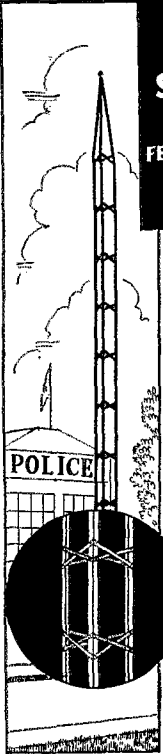

## RADIO COURSES

New Classes Now Starting

- RADIO OPERATING • BROADCASTING • CODE
- RADIO SERVICING • TELEVISION
- ELECTRONICS — 1 year day course; 2 years eve.
- Day and Evening Classes — Booklet upon request

### NEW YORK YMCA SCHOOLS

4 West 63rd Street, New York City

If you can use the regulation key—

You Can **Better--Faster--Easier** Send with the Easy-action

## VIBROPLEX No. 6 Semi-automatic Key

Great New No. 6

- Japanned Base \$17
- Nickel-Plated Base \$19

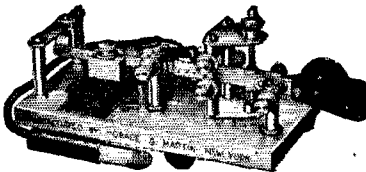

### Liberal Allowance on Old Vibroplex

New design. You'll like its many special features that make it so efficient and easy to use.

### JUNIOR

Smaller and more compact, but in all other details the same as large model. Only \$12.50

Its simplicity, mechanical perfection, machine speed and sending ease eliminates tiring arm work and helps you to send with the skill of an expert. Easy to learn. Simply press lever — Vibroplex does the rest. ORDER NOW! Prompt shipment. Money order or registered mail. Write for catalog.



The BUG trade mark identifies the Genuine Vibroplex.

THE VIBROPLEX CO., INC., 832 Broadway, New York, N. Y.

# The Radio Amateur's Handbook

The new 1939 edition of the "Radio Amateur's Handbook" is a thorough revision of the standard manual of amateur communication. A tremendous quantity of new equipment was constructed exclusively for this Edition. The important transmitter chapter has been enlarged and has complete constructional data for units now described for the first time. It includes new diagrams with particular attention to determination of optimum L/C ratios and tank-condenser plate-spacings. Unit designs permit the construction of complete transmitters of any power up to the maximum allowed by amateur regulations. The radiotelephony section was rewritten with the thought of increasing its value to the practical amateur who wants to know more about the adjustment and operation of 'phone transmitters. Modulator data (particularly for the grid-bias and plate systems) will be found for each of the lay-outs featured in the transmitting chapter. Power supplies are of course fully covered so that you may pick the most suitable one. The antenna chapter has been expanded to give complete dope on all varieties from the simpler types to the more elaborate arrays. New treatment of feeder systems and the various antennas will make the operation of these more readily understood. Multi-band operation, antennas for restricted space, as well as complete information on rotary beams, is also to be found in this chapter. Other chapters have received equally thorough treatment. The fundamentals chapter has been simplified. The tube chapter has five pages of new tables to make this complete and up-to-date. New kinks will be found in the chapter on workshop practice. Four receivers have been added to the receiver section, including simple regenerative sets as well as superhets. As in the rest of the book, the emphasis is on proven circuits, with performance and economy foremost. Simple pre-selector and antenna-tuning units are described, together with material on tuning and signal-strength indicators. The transmitters to be found in the ultra-high-frequency chapters are of course designed to comply with the new regulations regarding stability; and the receivers to take advantage of this new set-up on 56 Mc. The still higher u.h.f. bands have not been forgotten, both receiving and transmitting gear having been built and described for the first time in this edition. Apparatus designed and constructed and actually used for the purpose, is included in the chapter on emergency and portable equipment. More effective laboratory equipment, practical for the amateur, is included in the instruments and measurements chapter. Of course the new amateur regulations are to be found in that ever useful source of information, the Appendix. With the extensive index, the reader can locate easily and quickly the information on the subject in which he is interested. Following the form of the previous Editions, putting in all information that is pertinent to the design, construction and operation of proven equipment, the 1939 "Handbook" is the most complete and comprehensive yet. Packed with practical information helpful to the old-timer and youngest beginner alike, concisely written in simple, understandable style, it is more than ever before the greatest dollar's worth in radio.

**\$1 postpaid in Continental U.S.A. — \$1.25 postpaid elsewhere**

Buckram bound edition, \$2.50

**American Radio Relay League**

**West Hartford, Conn.**

# Heard 'Round the World

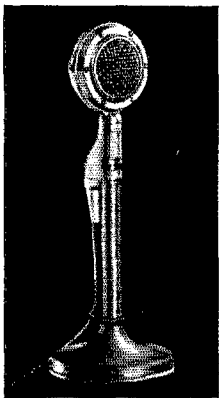

## SHURE 70SW SUPER LEVEL

Used by Amateurs and Professionals in more than 55 countries in all climates 'round the world! Gives clear, crisp speech that cuts thru noise and static! High output level and other extra-value features!

★ Satin Chrome head, with built-in Cable connector. 7 ft. shielded cable. Desk Stand in Iridescent Gray.

Model 70SW. List Price **\$25**

Model 70SWH. Same, without Desk Stand.

List Price.....\$22.50

## SEE THE NEW SHURE "ROCKET"

See the beautiful new Shure ROCKET de luxe communications-type crystal microphone. Model 706S complete with Desk Stand lists at \$27.50. Model 706SH, without Desk Stand, lists at \$25.

Ask Your Jobber. Write us today for Free Catalog 150Q

Shure patents pending. Licensed under Brush Development Co. patents.



## 110 VOLTS AC Anytime, Anywhere! with Katalight Plants

Have special plant for operating radio receivers and transmitters. Close voltage regulation. Full 850 watts AC and 100 watts at 6 volts. Filtered and Shielded. **\$66.00**  
Amateur's price.....

Other sizes up to 10,000 watts.  
Both Gasoline and Diesel.  
KATOLIGHT, Mankato, Minn., U.S.A.

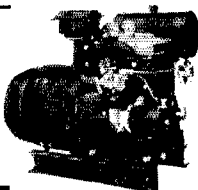

## RADIO ENGINEERING



RCA Institutes offer an intensive course of high standard embracing all phases of Radio and Television. Practical training with modern equipment at New York and Chicago schools. Also specialized courses and Home Study Courses under "No obligation" plan.

Illustrated Catalog on request

**RCA INSTITUTES, INC.** Dept. ST-39

A Radio Corporation of America Service

75 Varick St., New York 1154 Merchandise Mart, Chicago

## TYPE HFM TRANSMITTER

"THE TRANSMITTER OF THE FUTURE"

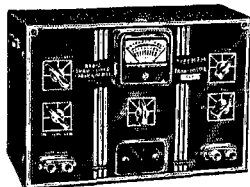

- Six Bands 1715 — 60,000 K.C. on two crystals
- All Frequencies Crystal Controlled
- Instantly Changeable Mobile or Portable
- Final Tube Input 21 to 36 Watts

Net to Amateurs. **\$57.60**  
Write for bulletins listing our complete, new and approved line for amateurs.

## RADIO TRANSCEIVER LABS.

8627 115 Street · Richmond Hill, New York City

CABLE ADDRESS: "RATRALAB"

W4CQ-W4EBA W4FIX-Charles Lloyd Williams W4FFH  
W4EFX M. S. Huggins. *Seventh Naval District:* K4KD-  
K4RJ-W4BHW-Frank J. Andrews-William McG. Bonham-  
Robert B. Rives W4FMA-W4ZU-Arthur L. Prado W4DUC-  
W5GOH/4 Frank L. McGuire-Walter Vancaeyzelle, Conrad  
Markle, Jr. WIART/4 W4DHD. *Eighth Naval District:*  
W4CRP-W5BKH-W5DDJ-W5DGB-W5DXQ-W5KC-  
W5OJ-Thomas E. Brown-E. G. Roberts W4AXV-W5BRV-  
W5CLP-W5CWW W5CKN-W5FTU-Edward B. McIntyre-Arba E. Mack, Jr. W5AZB-W5BAM-W5BNO-  
W5HLI W5DXA-W5FRZ W4PL W4BAO W5BVF  
W4EFR W5HEN-Joseph Oscar Braden-Herbert Pickett-  
William Gerald Stryker, David Sinclair W5GCU W5GTN  
W5FRB. *Ninth Naval District:* W8ARR-W8DVP-W8GKG-  
W8HS-W8HSW-W8JHN-W8KRG-W8LAG-W8LST-  
W8PYT-W8RLS-W9AIR-W9BIS-W9CON-W9GFL-  
W9JQZ-W9UZ-W9VDQ-W9VEE-W9VES-W9WGU-  
W9ZHD-Omer Collins-John V. Fill-Steven C. Garcia-  
Merle D. Gow-W. J. McGuffage-William Vernon O'Neal  
W8NDL-W8NHO-W8SQJ-W9AUA-W9DXI-W9ERU-  
W9HPG-W9KFJ-W9MFFH-Lucien Casto-Lorence F. Weaver  
W8CBC-W8DCE-W8DWT-W8FJW-W8GVB-  
W8HA-W8LKP-W8QQY-W8RKK-W8SBT-W9AYH-  
W9CFP-W9ELL-W9MWU-W9ZYM W8ORX-W9AGQ-  
W9BWN-W9DUO-W9ENQ W9EJV-W9SKR-W9YYE-  
W9YZX-Edwin H. Davidson-David R. Hilligoss-H. I.  
Lundmark W8OHV-W9ANV-W9CA-W9DRE-W9PCC-  
W9RZA-Nathan Williams W9HNV-W9YWE Mary Jane  
Gunter W8GAV W9YTW W9LWU-W9PAN W8CPLY-  
W9RTN-James C. Smith, Jack C. Baker W9IZQ W8MCV-  
W9ACU W9EJS W9PB W9IQZ Herschel Meest W9DEB  
W9WTT W9YNQ W9VFM Willard A. Hayward. *Eleventh  
Naval District:* W5GDP-W6CQK-W6JLU-W6LDD-  
W6ODQ-W6OEQ-W. A. Boykin-Ralph Charles French  
W6ALK-W6BQX-W6BVD-W6CLY-W6FJK-W6FNG-  
W6JAR-W6NWX-W6OSX-W6PZZ-W8KUB/6-B. L.  
Pearl-F. L. Williams-D. F. Wilson W6OXQ W6CGY-  
W6HOS-W6MHX-W6PJC-George C. Hazenbush W6BBQ-  
W6NDF W6LM W6AJM. *Twelfth Naval District:* W6AAX-  
W6CWR-W6EK-W6FOF-W6GUR-W6NCF-W6NGY-  
W6NKK-W6NNW-W6OIA-W6OMR-W6OPP-W9KSE-  
W9LQO-Clarence M. Griffith-M. B. Hall-Samuel Slavin  
W6ATT-W6BUF-W6DJQ-W6EQC-W6GIV-W6HWU-  
W6MUC-W6QCR W6BYS-W6PIP-W6PQX-W9TDS-  
W9TSQ-Junior D. Bradshaw W6JZL-W6MCS W6AII-  
Clyde Foreman-Fred B. Gallien W6ZF W6GJ-W6PLJ  
W6PGB Kenneth T. Hill W6AK W6CHL V. J. Deacon,  
Earle A. Conquest W6PGH. *Thirteenth Naval District:*  
W7AJ-W7GLH W7AOA-W7JK-W7WY-T. E. Erdmann-  
Herman F. Laes-Wesley B. Otto-Douglas H. Reid-Phillip  
W. Roberts W7AND-W7AVC-W7EHO-W7EOR-Robert  
M. Christensen W7DJJ-W7EBQ-W7ETO-W7GBF-  
W7GGM-J. L. Pouts W7BAN-Ralph W. Lindahl W7BAK  
W7APR W7DXF-W7FSF H. G. Halleck W7HCD W7ANN  
W7OS W7FSD Lloyd Francis Jordan W7AMG W7GDB  
W7FZB W7FPZ. *Fourteenth Naval District:* K6FAZ  
K6LKN. *Miscellaneous:* VE4GD W9MYF Joseph M.  
Dushay VE3AJN VE3LA.

## What's Your Crystal Frequency?

(Continued from page 35)

wide variations in these constants one can expect variations in frequency up to approximately 2000 cycles in a 3500-kc. crystal. This deviation may be either plus or minus, and if you intend operating near the edge you must make allowance for it.

Has your frequency ever jumped for no apparent cause? Did you know that this will happen in either the A, B, V, X, or Y cuts, if the plate is not optically flat or perfectly plane on both faces? A critical temperature or adjustment can be reached at which the crystal will very suddenly shift to a few cycles to several hundred kilocycles away from the normal frequency. This happens

# Station Operating Supplies

*Designed by A.R.R.L. Communications Department*

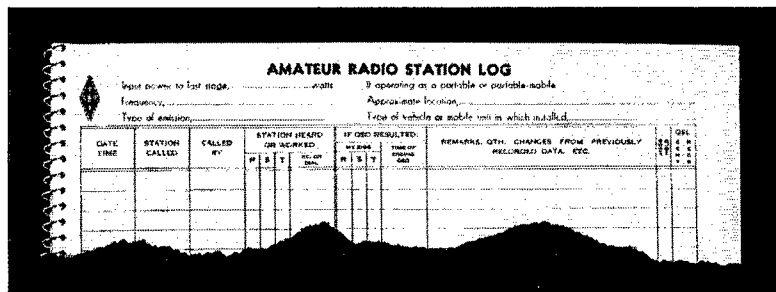

★  
**THE  
LOG  
BOOK**



As can be seen in the illustration, the log page provides space for all facts pertaining to transmission and reception, and is equally as useful for portable or mobile operation as it is for fixed. The 38 log pages with an equal number of blank pages for notes, six pages of general log information (prefixes, etc.) and a sheet of graph paper are spiral bound, permitting the book to be folded back flat at any page, requiring only the page size of  $8\frac{1}{2} \times 11$  on the operating table. In addition, a number sheet for traffic handlers is included with each book. The LOG BOOK sells for 35c per book or 3 books for \$1.

## **OFFICIAL RADIOGRAM PADS**

The radiogram blank is now an entirely new form, designed by the Communications Department to comply with the new order of transmission. All blocks for fill-in are properly spaced for use in typewriter. It has a strikingly new heading that you will like. Radiogram blanks,  $8\frac{1}{2} \times 7\frac{1}{4}$ , lithographed in green ink, and padded 100 blanks to the pad, are now priced at 25c per pad, postpaid.

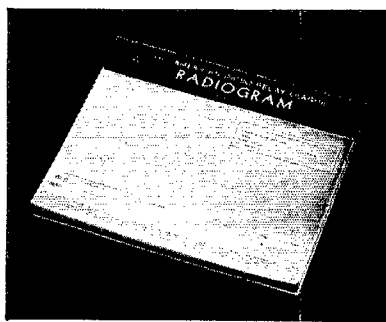

## *and* **MESSAGE DELIVERY CARDS**

Radiogram delivery cards embody the same design as the radiogram blank and are



available in two forms — on stamped government postcard, 2c each; unstamped, 1c each.

**AMERICAN RADIO RELAY LEAGUE, Inc.**

**West Hartford, Connecticut**

THE  
**NEW KEYING** *Grid Control*  
**RECTIFIER**



PRICE  
**\$3.50**

Key  
 your rig  
 the modern  
 electronic way  
 with this worthy  
 companion of the  
 famous UNITED 866.  
 Put out a signal that  
 does justice to your fist, by  
 eliminating tails and chirps.

FILAMENT . . . 2.5 volts, 5 amps.  
 PLATE CURRENT (average) . . . .25 amps.  
 PLATE CURRENT (peak) . . . .1.00 amp.

Your dealer has them or we will ship to you

**UNITED ELECTRONICS CO.**  
 42 SPRING STREET • NEWARK, NEW JERSEY

frequently in the poor grade plates and is caused by one of the surfaces, of a different thickness from the rest of the plate, assuming control; i.e., a high spot or, conversely, a low spot may control the frequency of oscillation. A perfectly plane or optically flat A, B, V or X cut crystal will *not* jump under normal conditions. The Y cut has a tendency to jump around regardless of how good it is or how flat it may be, and for this reason it has been discarded in favor of more stable plates.

If you tamper with your crystal, or remove it from the holder to clean it, you cannot expect it to have the same frequency again. Since few crystals or crystal-holder electrodes are absolutely plane or flat, merely changing the position of the crystal within the holder or changing the electrode pressure may shift the frequency by an appreciable amount. Spring pressure or electrode weights likewise change the activity or ability of a crystal to "pick up oscillation." Therefore it is well to be very careful when attempting to clean a crystal or its holder, and certainly advisable to check its frequency after the job is done.

*Crystal Limitations*

The power handling capabilities of crystals will vary according to the type of cut, the precision with which they are ground, and the manner in which they are used. In general, A and V cuts will handle more power than X or Y cuts. This may be explained by saying that every crystal has several modes of vibration and that these vibrations sometimes interfere with each other, as for instance, throwing two stones into a still pond of water in such a manner that the wave trains would interfere with each other. These undue strains on the crystal, if of sufficient intensity, will fracture or shatter the plate. Because of the reduction of these unwanted or coupled vibrations in the A, B, and V cuts, they will handle more power. Manufacturers usually specify maximum r.f. current for various types and cuts of crystals, and this information has led many amateurs to believe that they can always operate a crystal up to these limits with no thought as to heat dissipation or temperature rise. It is true that the crystal will operate up to and perhaps beyond the limits usually specified, but considerable thought must be given to the temperature problem. It is unwise to force a crystal to operate at its maximum power level, since in this condition extreme temperature effects can be expected. It is much better engineering to operate the crystal at low power and use another stage or tube for boosting up the power level. This is a requirement in all commercial transmitters where frequency tolerance is of importance.

Burning or spotting of crystal holder electrodes is a sure sign of overload on the crystal. The burning is caused by a corona discharge, and corona can only take place at high voltages. The factors controlling r.f. voltage across a crystal are the plate voltage, the value of grid leak, the type of tube and circuit, the LC ratio and the amount of feedback or coupling between the input and output circuits. When electrodes show dark spots,

**MEMORANDUM**

- ✓ You need a copy of the new best-yet 1939 Handbook.
- ✓ You need a binder for your 1938 QST's — and another for 1939.
- ✓ You need the new edition of the License Manual with all new regs.

**FEBRUARY, 1939**



# Isolantite + HAMMARLUND = Quality

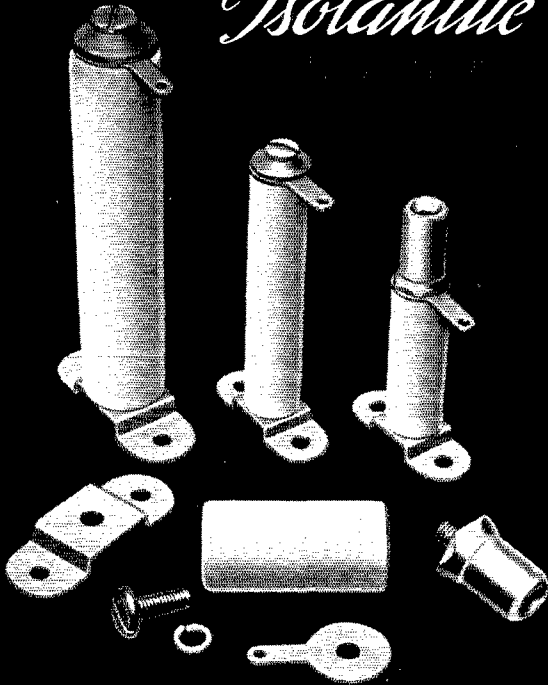

TWO GREAT NAMES combine to make these new Hammarlund stand-off insulators outstanding in every detail. The use of Isolantite reduces chipping and breakage and insures long-lasting service. Threads will not strip or wear off as with ordinary porcelains. All hardware is cadmium plated brass and of extra heavy material. The terminal is heavy cadmium plated copper. Available in eight convenient sizes of  $\frac{1}{8}$ " and  $\frac{3}{4}$ " diameters and from  $\frac{3}{4}$ " to  $3\frac{1}{2}$ " long. The Isolantite bars are available separately or with plain or jack type tips and mounting bases. If you are looking for insulators that "can take it" and want to save money, ask your jobber to show you Hammarlund's new "stand-offs." Also included in this new line of insulators are Isolantite beads for insulating heavy flexible connectors and Isolantite feed-through bushings for use with metal chassis.

**HAMMARLUND MFG. CO., Inc.**  
424 W. 33rd ST., N. Y. CITY  
Canadian Office: 41 West Avenue No.,  
Hamilton, Ontario

## SICKLES COILS

SECURE A COPY OF OUR NO. 939  
CATALOG FROM YOUR JOBBER

F. W. SICKLES COMPANY

300 Main Street

Springfield, Mass.

## Piezo-Electric Crystals Exclusively

- Quality crystals of all practical frequencies supplied SINCE 1925. Prices quoted upon receipt of your specifications.

Our Pledge: **QUALITY FIRST**  
**SCIENTIFIC RADIO SERVICE**

"The Crystal Specialists Since 1925" University Park, Hyattsville, Md.

## ● TELEGRAPHY—TELEVISION—TELEPHONY ●

AVIATION

TRANS RADIO  
PRESS

TELETYPE

TYPEWRITING

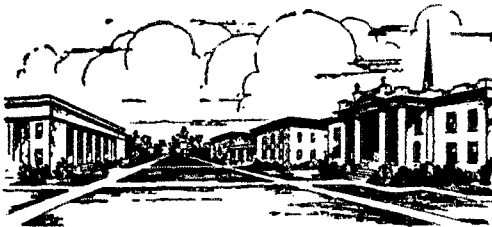

PRACTICAL  
EXPERIENCE  
STUDIO —  
TRANSMITTER —  
ANNOUNCING

The major technical training equipment owned by Port Arthur College and in operation on the college campus consists of the 500-Watt Commercial Broadcast Transmitter of Station KPAC; two-way Television Transmitter and Receiver; Latest Type RCA Marine and Airways transmitter installation complete; SOS Automatic Alarm; Marine Direction Finder; Trans-radio Press Receiving Equipment; and Laboratory complete where students assemble composite transmitters, amplifiers, audio amplifiers, R. F. amplifiers, etc.

Port Arthur College pioneered the teaching of Radio with classes in 1909, and for thirty years has maintained an active Employment Bureau for the placement of its graduates.

*If interested in details about Radio Course, write for Bulletin R*

**PORT ARTHUR COLLEGE** ■ **PORT ARTHUR (World-Known Port), TEXAS**

# QST

## YEARLY BINDERS



## Are We Right?

You should have at least two of them — one for your complete 1938 file of copies, and one for each 1939 issue as published.

•

With each Binder is furnished a sheet of gold and black gummed labels for years 1922 through 1941. The proper one can be cut from the sheet and pasted in the space provided for it on the back of the binder.

•

Price **\$1.50** postpaid

*Available only in United States and possessions, and Canada*

**THE AMERICAN RADIO RELAY LEAGUE**  
West Hartford, Conn.

better play safe and reduce the plate voltage or reduce the value of grid leak, both of which will help to reduce the r.f. voltage across the crystal. In the case of tubes requiring feedback condensers, the capacity should be reduced until the feedback is just enough so that the crystal will key properly. As a matter of fact, it has been found that excessive feedback will sometimes reduce the keying speed of a crystal, therefore the proper amount of feedback is important. Frequently in amateur practice the crystal oscillator is a 6L6 or an 807 tube, with full plate voltage on it, and is used to drive another 6L6, 807, or RK39 beam tube which requires less than  $1\frac{1}{2}$  watts of driving power. In this case, the crystal oscillator may have as much as fifty watts input, of which only one to two watts are needed; the rest is simply wasted. It might be well to point out that over-excitation of a beam tube amplifier actually causes the output power to go down! It would seem sensible to regulate the power into the crystal oscillator to such a level that just enough excitation to the next stage is provided. In this condition, you will be amazed at the stability and freedom from frequency drift of your oscillator. Probably you will find that from 3 to 5 watts input to the oscillator will be sufficient to excite the next stage, assuming that you are using either a 6L6, 807, or RK39 following the crystal. Of course, if you use a triode or tube requiring more excitation, then greater power output must be obtained from the oscillator. The beam tubes are recommended, however, because of their ability to deliver high outputs with very small excitation power.

### *Harmonic Crystals*

Now a word about harmonic-type crystals. In reality they are good A-cut or similar crystals which will oscillate at their third harmonic in addition to the fundamental frequency. Thus, a good (optically flat) 80-meter crystal also will oscillate at 26.6 meters. A thick-cut 40-meter crystal is really a 120-meter plate oscillating at its third harmonic; likewise a 20-meter crystal operates on 60 meters, too. Crystals have been produced that will oscillate at harmonics as high as the seventh. Because of the small amount of power available in the crystal circuit, particularly on a harmonic, it is necessary to take precautions to obtain the correct amount of feedback, and consequently the circuit constants are somewhat more critical. This may explain why many amateurs have not been successful with this type of crystal. As was explained at the beginning of this paragraph, only good optically flat units will oscillate on harmonics; the permissible tolerance decreases very sharply with frequency so that it is impracticable to "hand make" harmonic crystals. They are generally made in automatic lapping machines which hold thickness variations within a few millionths of an inch. In harmonic crystals the temperature coefficient is multiplied according to the harmonic used; thus a third-harmonic plate will have three times the fundamental-frequency coefficient. The same would be true if the crystal worked at its fundamental

# Where to buy it

A directory of suppliers who carry in stock the products of these dependable manufacturers.



**ALBANY, N. Y.** Uncle Dave's Radio Shack 356 Broadway  
**ATLANTA, GEORGIA** Wholesale Radio Service Co., Inc. 265 Peachtree Street  
**BOSTON, MASS.** Radio Shack 46 Brattle Street  
**BOSTON, MASS.** Wholesale Radio Service Company, Inc. 110 Federal Street  
**BRONX, N. Y.** Wholesale Radio Service Company, Inc. 542 East Fordham Rd.  
**BUTLER, MISSOURI** Henry Radio Shop 211-215 N. Main Street  
**CHICAGO, ILL.** Allied Radio Corp. 833 W. Jackson Blvd.  
**CHICAGO, ILL.** Wholesale Radio Service Company, Inc. 901-911 W. Jackson Blvd.  
**COLUMBUS, OHIO** Bell Radio Parts Co. 203 N. Fourth St.  
**DETROIT, MICH.** Radio Specialties Co. 325 E. Jefferson Ave.  
**DETROIT, MICHIGAN** Radio Specialties Co. 11800 Woodward Ave.  
**HARTFORD, CONNECTICUT** Radio Inspection Service Company 227 Asylum Street  
**HOUSTON, TEXAS** R. C. Hall & L. F. Hall Box 2434  
**JAMAICA, L. I.** Wholesale Radio Service Company, Inc. 90-08 166th Street  
**KANSAS CITY, MO.** Burstein-Applebee Company 1012 McGee Street  
**NEW ORLEANS, LA.** Shuler Supply Company 902 Poydras Street  
**NEW YORK, N. Y.** Harrison Radio Co. 12 West Broadway  
**NEW YORK, N. Y.** Wholesale Radio Service Co., Inc. 100 Sixth Ave.  
**NEWARK, N. J.** Wholesale Radio Service Co., Inc. 219 Central Ave.  
**OAKLAND, CAL.** Offenbach Electric Co. 2085 Broadway  
**POTTSVILLE, PENN.** Jones Radio Company E. Norwegian & George Sts.  
**READING, PENN.** George D. Barbey Company 404 Walnut St.  
**READING, PENN.** Jones Radio Company 104 North Ninth Street  
**SAN FRANCISCO, CAL.** Offenbach Electric Company 1452 Market Street  
**SPRINGFIELD, MASS.** T. F. Cushing 349 Worthington St.  
**WASHINGTON, D. C.** Sun Radio & Service Supply Co. 938 F Street, N. W.

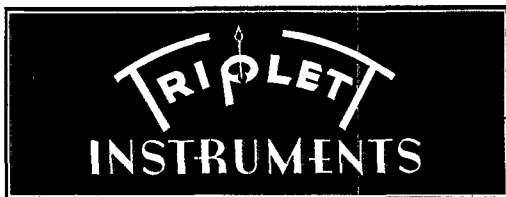

**ALBANY, N. Y.** Uncle Dave's Radio Shack 356 Broadway  
**ATLANTA, GEORGIA** Garvin Electric Company 69 Forsyth Street, N. W.  
**ATLANTA, GEORGIA** Wholesale Radio Service Company 265 Peachtree Street  
**BOSTON, MASS.** Radio Shack 46 Brattle Street  
**BOSTON, MASS.** Wholesale Radio Service Company, Inc. 110 Federal Street  
**BRONX, N. Y.** Wholesale Radio Service Company, Inc. 542 East Fordham Rd.  
**BUTLER, MISSOURI** Henry Radio Shop 211-215 N. Main Street  
**CHICAGO, ILLINOIS** Allied Radio Corp. 833 W. Jackson Blvd.  
**CHICAGO, ILLINOIS** Electric & Radio Supply Co., Inc. 25 North Franklin Street  
**CHICAGO, ILL.** Wholesale Radio Service Company, Inc. 901-911 W. Jackson Blvd.  
**DALLAS, TEXAS** Southwest Radio Supply 1905 Commerce Street  
**JAMAICA, L. I.** Wholesale Radio Service Company, Inc. 90-08 166th Street  
**LITTLE ROCK, ARKANSAS** Beem Radio Company 409 W. 3rd St.  
**MINNEAPOLIS, MINNESOTA** Low Bonn Company 1124-26 Harmon Place  
**MONTREAL, CANADA** Canadian Electrical Supply Co., Ltd. 285 Craig Street, West  
**NEW ORLEANS, LA.** Shuler Supply Company 902 Poydras Street  
**NEW YORK, N. Y.** Wholesale Radio Service Company 100 Sixth Avenue  
**NEWARK, N. J.** Wholesale Radio Service Company 219 Central Ave.  
**OAKLAND, CAL.** Offenbach Electric Co. 2085 Broadway  
**POTTSVILLE, PENN.** Jones Radio Company E. Norwegian & George Sts.  
**READING, PENN.** George D. Barbey Co. 404 Walnut Street  
**READING, PENN.** Jones Radio Company 104 North Ninth St.  
**SAN FRANCISCO, CAL.** Offenbach Electric Company 1452 Market Street  
**WASHINGTON, D. C.** Sun Radio & Service Supply Co. 938 F Street, N. W.

Listings on this page do not necessarily imply endorsement by QST of the dealers or of other equipment sold by them.

**DON'T GUESS... USE**

**TRIPLET**

**MODULATION  
MONITOR**

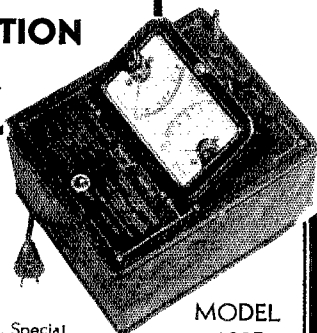

Model 1295 Modulation Monitor enables you to tune your transmitter to maximum efficiency thereby saving the power loss of undermodulation. Result — clearer signal to distant stations. For all voice transmitting stations. Special construction high speed meter indicates modulation percentage.

Case is metal with Black Wrinkle Finish. Etched panel is Silver and Red on Black.

MODEL  
1295

Dealer  
Price  
**\$24.83**

**SEE YOUR JOBBER — WRITE FOR CATALOG**

THE TRIPLETT ELECTRICAL INSTRUMENT COMPANY

252 Harmon Avenue, Bluffton, Ohio

## RADIO

**ENGINEERING**, broadcasting, aviation and radio telegraphy and telephony, Morse telegraphy and railway accounting taught thoroughly, 48 weeks' engineering course, equivalent to three years of college radio work. School established 1874. All expenses low. Catalog free.

DODGE'S INSTITUTE, Day Street, Valparaiso, Indiana

## QSL Cards

Individual QSL Cards printed as you want them, at reasonable prices.

Samples gladly submitted on request.

**HINDS & EDGARTON, INC.** W 9 W R  
Ex. W9APY  
19 South Wells Street, Chicago, Illinois

## LEARN CODE RIGHT

Always ready — no weather interference — beats having someone send to you. Speed range 5 to 40 W.P.M. Radio or Morse.

STANDARD with 10 tapes and book of instructions.....\$20.25

JUNIOR with 5 tapes and book of instructions (not rented).....\$12.00

Complete oscillator equipment less battery.....\$6.50

RENTAL Standard with 10 tapes and book of instructions \$3.00 first month, \$2.25 each additional month.

With transformer and tube socket 25¢ per month more. With key and head phones 50¢ per month extra. \$10 deposit or business references required.

Write for details today

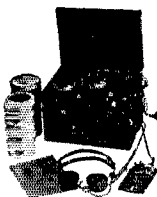

## INSTRUCTOGRAPH COMPANY

Dept. Q-2, 912 Lakeside Place, Chicago, Illinois

Representatives for Canada:

Radio College of Canada, 863 Bay Street, Toronto

and if you multiplied the frequency three times by means of tubes.

A few notes on how to change a finished crystal's frequency may be in order. While they are not generally recommended, these kinks may help someone to keep inside the band or to move slightly off extreme interference. The frequency may be lowered somewhat at the expense of decreased activity by increasing the electrode pressure or the size of the electrodes. This is not recommended for high frequency (non-harmonic) 20- and 40-meter plates, however. In some instances, the application of two or three coats of india ink will lower the frequency by several hundred cycles. Make certain that the edges of the crystal are clean and that the ink does not run over them to cause a short circuit. Perhaps a slight baking process after the inking would be excellent to remove all moisture. A soft pencil also can be used to accomplish the same purpose by applying a heavy coat of graphite in the same manner as the ink. A thin "shim" in the form of a small piece of paper can often be used to increase the frequency by a few hundred cycles. Of course, air gaps can be employed in many ways to raise or lower frequency.

In conclusion, the F.C.C. rules specify that, "Sidebands resulting from keying or modulating a transmitter shall be confined within the band used." We must not operate too near the edge of a band. When, for instance, we work within 500 cycles of the edge at 14,400 kc. we must have the frequency-measuring device, independent of a transmitter, capable of measuring within 0.0000347 per cent, or one part in 28,800. Very few, if any, self-excited oscillators will maintain such an accuracy. Those costing in the vicinity of \$500.00 cannot be relied upon for much better than 0.1 per cent! Your meter will be checked if you are ever caught off frequency—and it will be just too bad if you cannot comply.

For safety's sake the writer would recommend that you use only the best quality low-drift crystals if you intend to play near the edges, and even then you had better be several kilocycles inside to allow for all the variable factors already mentioned in this article.

## FREQUENCY

measurements easily and accurately attained with the new type DFS dual frequency crystal which oscillates at 100 and 1000 Kc.

Small, compact, and attractively mounted in a bakelite holder designed for easy mounting.

It is a valuable aid to radio servicemen for calibrating receivers, oscillators, etc.

Amateurs will find this new low priced unit invaluable for frequency measurements in the amateur bands.

Net Price, mounted — \$7.25

**THE VALPEY CRYSTALS**

Box 321

Holliston, Mass.

# HAM-ADS

(1) Advertising shall pertain to radio and shall be of nature of interest to radio amateurs or experimenters in their pursuit of the art.

(2) No display of any character will be accepted, nor can any special typographical arrangement, such as all or part capital letters be used which would tend to make one advertisement stand out from the others.

(3) The Ham-Ad rate is 15¢ per word, except as noted in paragraph (6) below.

(4) Remittance in full must accompany copy. No cash or contract discount or agency commission will be allowed.

(5) Closing date for Ham-Ads is the 25th of the second month preceding publication date.

(6) A special rate of 7¢ per word will apply to advertising which, in our judgment, is obviously non-commercial in nature and is placed and signed by a member of the American Radio Relay League. Thus, advertising of bona fide surplus equipment owned, used and for sale by an individual or apparatus offered for exchange or advertising inquiring for special equipment, if by a member of the American Radio Relay League takes the 7¢ rate. An attempt to deal in apparatus in quantity for profit, even if by an individual, is commercial and all advertising by him takes the 15¢ rate. Provisions of paragraphs (1), (2), (4) and (5) apply to all advertising in this column regardless of which rate may apply.

Having made no investigation of the advertisers in the classified columns, the publishers of *QST* are unable to vouch for their integrity or for the grade or character of the products advertised.

**QUARTZ**—direct importers from Brazil of best quality pure quartz suitable for making piezo-electric crystals.

Diamond Drill Carbon Co., 719 World Bldg., New York City.

**RADIO** engineering, broadcasting, aviation and police radio, servicing, marine and Morse telegraphy taught thoroughly. All expenses low. Catalog free. Dodge's Institute, Byrd St., Valparaiso, Ind.

**USED** receivers. Bargains. Cash only. No trades. Price list 3¢. W3DQ, Wilmington, Del.

**QSL's**, all colors, cartoons, snappy service. Write for free samples today. W1BEF, 16 Stockbridge Ave., Lowell, Mass.

**CALLBOOKS**—Winter edition now on sale containing complete up-to-date list of radio hams throughout entire world. Also world prefix map, press schedules and new time conversion chart. Single copies \$1.25. Canada and foreign \$1.35. Radio Amateur Call Book, 610 S. Dearborn, Chicago.

**RADIO** control—Send stamp for circulars showing latest equipment. Lightweight, reliable, guaranteed to perform. Radio Control Headquarters, Granby, Conn.

**QSL's**, Cuts. Cartoons. Free samples. Theodore Porcher, 7708 Navahoe, Philadelphia, Pa.

**IPS** rubber crystal. QSY remotely, varies completely 160 to 10 meters. Approximately 20 watts output, \$19.80. Radio Apparatus Mfg., 1522 No. Clark, Chicago. W9IPS.

**QSL's**—W8NOS.

**LISTEN** for high-frequency broadcast station W9XA, 26,450 kilocycles, Kansas City. Programs of interest to short-wave listeners and radio amateurs.

**QSL's**, SWL's: one color 45¢, two color 60¢ hundred, postpaid. Samples. W1FTM, 268 Piedmont, Waterbury, Conn.

**CRYSTALS**: X-cut 1" sq. 80—160, \$1.40; mounted, \$2.25; 40, \$2.50; mounted, \$3.25, ≈3 kilocycles. Guaranteed the best. The Ransom Lab., No. Syracuse, N. Y.

**QSL's**. Free samples. Printer, Corwith, Iowa.

**CRYSTALS**, mounted, 80—160 \$1.25, V-cut 40 \$2.25. H9 Crystals, 338 Murray Ave., Arnold, Pa.

**QSL's**, SWL's. 100—3 color—75¢. Lapco, 344 W. 39th, Indianapolis, Ind.

1000 watt G.E. transformers 1100—2200—4400 volts each side c.t. Guaranteed. \$13.50. Dawson, 5740 Woodward, Detroit, Mich.

**QSL's**, samples. Meador, Box 1534, Savannah, Ga.

**SELL**: new 804, \$10; used SW-3, A-1 condition, coils, tubes, power supply, \$25. W8ODB, 1201 So. Liberty, Alliance, Ohio.

**QSL's**. Write W3DEE.

**SELL**: 2000 v. 1 k.w. supply, has auto-transformer to vary power input, Thordarson transformer, swinging choke, pyranol condensers, \$50.; also 2 RK-36's, 2 WE-27A's, and Cardwell TL-80-UD condenser. What am I offered? W1GEX, Box 188, Westwood, Mass.

**PHOTOGRAPHIC** QSL's from your negative, Holmes Photo Service, 522 Ardmore Blvd., Wilkensburg, Pa.

FOR sale at your price; standard radio broadcasting equipment. Write for list and make bid. KGBZ Broadcasting Co., York, Neb.

**QSL's**. W8DED QSL's bring more returns. Samples? W8DED, Holland, Mich. (Biley xtals? Patronize W8DED.)

**SWAP** welding transformer for xmitter or parts. Lewis Reiber, Rt. 2, W. Middlesex, Pa.

**SELL**: Utah 80 watt CW rig. Tubes, meters, xtal. Practically new, \$40. Aaron Goodhines, W8RXA, Boonville, N. Y.

**CRYSTALS** ground to order. X-cut, 1750—2000; 3500—4000. ≈20 k.c. \$1., ≈10 k.c. \$1.35; ≈5 k.c. \$1.50. Spot frequency, \$2.50. All crystals and blanks cut from best grade Brazilian quartz. Guaranteed to work as good as any crystal at any price. Three small, X-cut, 80 meter blanks, including carborundum, \$1.45. William Threm, W8FN, 3071 Moosewood St., Cincinnati, Ohio.

**QSL's**. Don't buy until you see ours. Samples. Radio Printer, Union, N. Y.

**MUST** sell new SX16 Skyriider, \$95. Write Alois Krispinsky, 712 Mabel, Youngstown, Ohio.

**SELLING** SX-16 Super Skyriider, excellent condition, with crystal and speaker, express collect or F.O.B. Bridgeport. Price complete, \$95, Peter Clarke, 264 Burrill Ave., Stratford, Conn.

**WESTON** meters, 35 mostly new, half price and less. Also hundreds of other ham items. Write for list. Henry C. Wing, Greenfield, Mass.

**CRYSTALS**: Eidson's T9, 40—80 m., \$1.60. Holders, \$1. C.O.D.'s accepted. Espy's, W5CXH, 2223 State, New Orleans.

**FOR** sale: used omnigraph. Cost \$30. new—sell cheap. W9MYD, Fessenden, N. D.

**SELL** or swap—transceiver, meters, parts, miscellaneous equipment. List free. W9ZOB, Box 368, Long Prairie, Minn.

**SELL**: 30 w. public address system, 100 w. transmitter. Send for description. Harold Henry, Clarion, Iowa.

**HATE** to, but must sell brand-new RME69 with crystal, noise silencer, speaker, and tubes. Used two months. Gray finish. \$99. W2KTC, 153 Schenck Ave., Brooklyn.

T9 crystals are setting the pace in high performance, dependability, and economy—try one and be convinced. Satisfaction guaranteed. 40 and 80 meter bands, fracture resisting X-cut, \$1.60; 7301—7500 k.c. range, \$2. postpaid. Improved T9 ceramic holders, \$1. C.O.D.'s accepted. Commercial crystal users send for literature. Sold by: Hieronymus Radio, 88-34 209th St., Queens Village, N. Y.; Van Radio, 464 E. 117th St., No. 7, Cleveland, Ohio; Espy's, 2223 State St., New Orleans, La.; Radio Atlas, Tampico, Mexico; Henry Radio Shop, Butler, Mo.; Frank Anzalone, 375 W. 46th St., N. Y. C.; Casa Edison, Havana, Cuba; and Eidson's, Temple, Texas.

**DOUGLAS** Universal modulation transformers. 50 watts audio \$4.95 pair; 100 watts audio. \$7.75 pair. One year guarantee. Postpaid in U. S. Free advice and data. Write W9LXR, Rice Lake, Wis.

**CRYSTALS**: 160, 80 meter low temperature coefficient AT cuts, within five kilocycles, \$2.25. 80 meter X cuts, \$1.50. Holders, \$1. Ham Crystals, 1104 Lincoln Place, Brooklyn, New York.

**TELEPLEXES**, instructographs, receivers, bought, sold. Ryan's, Hannibal, Mo.

**GENERAL** Electric dynamotors 24/750 volts 200 mils. new, \$15. Westinghouse 27½/350, \$10.; 6-15 volt 500 watts with propeller, \$8. 500 cycle 500 watts, \$8. Henry Kienzle, 215 Hart Blvd., Staten Island, N. Y.

**CRYSTALS**: airmailed; 20 m. mounted, \$4.50; 160-80 m. lodrift, 40X, \$1.95; 40 m. lodrift, \$2.75; C.O.D.'s accepted. C-W Mfg. Co., 1170 Esperanza, Los Angeles.

**ROTARIES** you can afford. Complete motor driven heads, \$25. Telescoping tapered aluminum elements, Selsynchronous indicators, tilting heads. Rotary Array Service, W8MLL.

**CRYSTALS**: mounted; 40X, \$1.60; 160-80; \$1.25; C.O.D.'s accepted. Pacific Labs., 344 Fetterly, Los Angeles.

**SIGNAL** shifters. Vertical radiators. Rotary beams. New and used receivers. Transmitters. New and used transmitting tubes. Crystal microphones. Biley crystals. W8ANT.

**COMMUNICATION** headquarters. Transmitters designed and built to order. Receivers serviced. All phases of high frequency communication. Write to Southern Ohio's only amateur owned amateur business. Jos. N. Davies, W8ANT, 2767 No. Bend Rd. Sta. A., Cincinnati, Ohio.

**QSL's**: 100—50¢ postpaid. Samples. Howe Brothers, Wisner, Neb.

**RECONDITIONED** guaranteed communications receivers shipped on ten day trial. Practically all models at big savings. Terms. List free. W9ARA, Butler, Mo.

**BEST** place to get communications receivers is from W9ARA. Best trades, best terms, ten-day trial. I will help you get the best receiver for your use. Write. W9ARA.

**QSL's**. W8BZK, Newark, Ohio.

**BARGAINS:** 150 watt transmitters with power, \$49.50. New, fully guaranteed. Terms, Frampton Radio Service, Blackwell, Okla.

**QSL'S.** 1939 designs. 50¢ to \$2. per hundred. W2FJE, 101 Hanson Place, Brooklyn, N. Y.

**FREE catalog.** Order direct or from dealers. 160-80 meter Y crystals, 75¢. Fabradio, Batavia, Ill.

**QSL'S.** Finest at lowest prices. Samples. Maleco, 1805 St. Johns Place, Brooklyn, N. Y.

**HRO power supply,** latest model, like new, \$130. W2EXR.

**CALL letters.** Polished cast alloy aluminum call letters and numbers 2" by 2 3/4", 1/4" thick, 15¢ each, or A.R.R.L., U.S.N.C.R., and A.A.R.S. Mounted on bar to fit license plate, \$1. each. Satisfaction guaranteed. E. Bailey, W. Newton, Pa.

**SELL:** slightly used instructograph. Also 110 volt 150 watt a.c. generator. Wanted: volt-ohm-milliammeter, and tube tester. W8RTE, Rockford, Mich.

**WANTED**

*Men who can sell,* direct to City, County and State Governments, high quality Police and Fire Radio Communication Equipment—No investment necessary—Commission basis—This may be your opportunity to step ahead in a fully protected territory—What are your qualifications? Address: Box E, Adv. Dept. QST, West Hartford, Conn.

**AMATEUR RADIO LICENSES**

Day and Evening Classes in Code and Theory  
HOME STUDY COURSES

*Reasonable, Efficient and Thorough, Hundreds of Licensed Students Now on the Air*

American Radio Institute, 1123 Broadway, New York, N. Y.

**HOW TO BE WELL POSTED ABOUT MICROPHONES**

**IT'S YOURS FREE**—the new two-color Turner catalog showing 21 new crystal and dynamic microphones. This catalog tells you about the level, response and application of each microphone. It will pay you to see the new styles which add a professional air to your equipment. Modern accessories are shown also. For example, see the new "Third Hand". You'll be better informed about microphones when you have read this booklet—and it's free to you! Just write on a postal card "Send me Booklet 40-E".

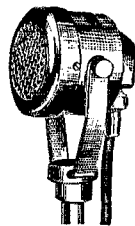

Write Today!

**THE TURNER CO.**  
CEDAR RAPIDS, IOWA, U.S.A.

MODEL 99  
DYNAMIC



**NEW HOLDER DESIGN**  
15 SECONDS TO  
INSTALL CRYSTAL  
For All Bands  
GREATER STABILITY  
Plugs in 5 prong tube socket  
Beautiful Appearance

**MODEL AH HOLDER \$1.00** At your dealer or direct

**HIPOWER LOW DRIFT CRYSTALS:**  
within 10 kc. or Choice of stock

AH-10, 1700-3500 Kc. bands \$2.35

AH-10, 7000-7300 " bands 3.90

WRITE FOR NEW LITERATURE

Hipower "Low Drift" Broadcast and Commercial Crystals Are Approved by F.C.C.

Hipower Crystal Co., 2035 Charleston St., Chicago

**DON'T Take Chances in the DX Contest**  
Play Safe with G-E Capacitors



Don't run the risk of a capacitor's blowing out. Not only will you lose out in the contest, but also there's the possibility of losing rectifier tubes, plate transformer, and other valuable equipment, in addition to the capacitor.

Here's why G-E Pyranol capacitors will stand up under long hours of continuous operation: Every one is subjected to exacting tests, including a double-rated-voltage test, before it is O.K.'d for your use. Not only that, each part—Pyranol liquid, paper, metal foil, bushing—must meet rigid specifications.



Rectangular Pyranol Capacitor

For new, low prices on G-E Pyranol capacitors or for bulletins, see your dealer or write Radio Department, General Electric, Schenectady, N. Y.

**GENERAL ELECTRIC**



# Your Nearest Dealer Is Your Best Friend

Your nearest dealer is entitled to your patronage. You can trust him. He is equipped with a knowledge and understanding of amateur radio. He is your logical and safe source of advice and counsel on what equipment you should buy. His stock is complete. He can supply your needs without delay. His prices are fair and consistent with the high quality of the goods he carries. He is responsible to you and interested in you.

Patronize the dealer nearest you—You can have confidence in him

## CHICAGO, ILLINOIS

Allied Radio Corporation  
833 West Jackson Blvd.

Complete standard lines always in stock—W9IBC, W9DDM, W9GEZ

## KANSAS CITY, MISSOURI

Burstein-Applebee Company  
1012-14 McGee Street  
"Specialists" in supplies for the Amateur and Serviceman

## KANSAS CITY, MISSOURI

Radiolab  
1515 Grand Avenue  
Amateur Headquarters in Kansas City

## CHICAGO, ILLINOIS

Chicago Radio Apparatus Company  
415 South Dearborn Street (Est. 1921)

W9RA and W9PST — Amateurs since 1909

## MILWAUKEE, WISCONSIN

Radio Parts Company, Inc.  
538 West State Street  
Complete stock Nationally Known products

## MINNEAPOLIS, MINNESOTA

Lew Bonn Co.  
1124-26 Harmon Place  
W9BP—W9TLE—W9ZXV—W9DKL—W9VED

## CHICAGO, ILLINOIS

Wholesale Radio Service Company, Inc.  
901-11 West Jackson Boulevard

"The World's Largest Radio Supply House"

## OAKLAND, CALIFORNIA

Offenbach Electric Company  
2085 Broadway  
"The House of a Million Radio Parts"

## SAN FRANCISCO, CALIFORNIA

Offenbach Electric Company, Ltd.  
1452 Market Street  
"The House of a Million Radio Parts"

## DES MOINES, IOWA

Iowa Radio Corp.  
1212 Grand Avenue  
Complete amateur stock, W9OCG—W9EMS—W9KAY

## SEATTLE, WASHINGTON

Northern Radio Company  
2208 Fourth Avenue  
W7AWP and W7CR to serve you

## DETROIT, MICHIGAN

Radio Specialties Company  
325 E. Jefferson Avenue  
Ham Supplies — National & Hammarlund Sets and Parts

## ST. LOUIS, MISSOURI

Van Sickle Radio Company  
1113 Pine Street  
W90WD invites you to amateur headquarters in St. Louis

YOU ARE PROTECTED  
WHEN YOU BUY FROM

**QST**

ADVERTISERS

“Advertising for *QST* is accepted only from firms who, in the publisher’s opinion, are of established integrity and whose products secure the approval of the technical staff of the American Radio Relay League.”

*Quoted from QST’s advertising rate card.*

*Every conceivable need of a radio amateur can be supplied by the advertisers in QST. And you will know the product has the approval of the League’s technical staff*

*Index to Advertisers*

Acme Electric & Mfg. Company, The.....	113
Aerovox Corp.....	102
American Radio Institute.....	124
Astatic Microphone Laboratory, Inc.....	107
Barker & Williamson.....	98
Bliley Electric Company.....	79
Candler System Company.....	102
Capitol Radio Engineering Institute.....	108
Cardwell Mfg. Corp., Allen D.....	84
Centralab.....	77
Collins Radio Company.....	Cov. 2
Cornell-Dubilier Electric Corp.....	106
Coto-Coil Company, Inc.....	94
Dodge’s Institute.....	122
Eitel-McCullough, Inc.....	83
Gardiner-Levering Company.....	96
General Electric Company.....	124
General Radio Company.....	111
Guthman & Company, Edwin L.....	92
Hallicrafters, Inc., The.....	1, 2
Hammarlund Mfg. Company, Inc.....	87, 119
Harvey Radio Company.....	120
Harvey Radio Laboratories.....	76
Henry Radio Shop.....	98
Hinds & Edgerton.....	122
Hipower Crystal Company.....	124
Howard Radio Company.....	95
Hytronic Laboratories.....	91
Instructograph Company.....	122
International Resistance Company.....	78
Johnson Company, E. F.....	89
Kato Engineering Company.....	116
Kelsey Presses.....	113
Ken-Rad Tube & Lamp Corp.....	113
Kenyon Transformer Company, Inc.....	5
Mallory & Company, Inc., P. R.....	74
Massachusetts Radio School.....	113
McGraw-Hill Book Company, Inc.....	86
Meissner Mfg. Company.....	99
Mims Radio Company.....	111
National Company, Inc.....	Cov. 3, 73, 96, 107, 113
New York YMCA Schools.....	114
Newark Electric Company.....	97
Ohmite Mfg. Company.....	108
Port Arthur College.....	119
Precision Apparatus Company.....	82
Precision Piezo Service.....	92
Premax Products.....	106
RCA Institutes, Inc.....	116
RCA Mfg. Company, Inc.....	Cov. 4, 110
Radio Mfg. Engineers, Inc.....	127
Radio Shack, The.....	109
Radio Transceiver Laboratories.....	116
Raytheon Production Corp.....	75
Scientific Radio Service.....	119
Shure Brothers.....	116
Sickles Company, F. W.....	119
Simpson Electric Company.....	80, 85
Solar Mfg. Corp.....	110
Sun Radio Company.....	117
Taylor Tubes, Inc.....	103
Teleplex Company.....	94
Terminal Radio Corp.....	112
Thordarson Electric Mfg. Company.....	93
Triplet Elec. Instrument Company, Inc.....	122
Turner Company, The.....	124
United Electronics Company.....	118
United Transformer Corp.....	128
Valpey Crystals, The.....	122
Vibroplex Company, Inc., The.....	114
Wholesale Radio Company, Ltd.....	112
Wincharger Corporation.....	114
Vazley.....	74
Zenith Radio Corporation.....	81



# LOOKING INSIDE

(The First of a Series)

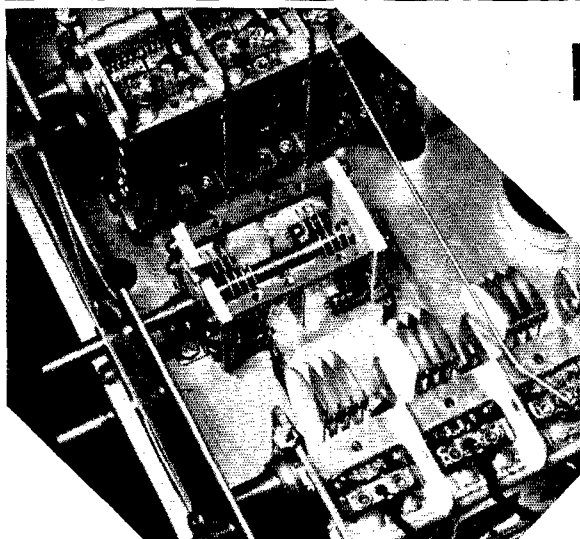

"Under the Dust Cover"

We, of RME, have long endeavored to make amateurs conscientiously critical when a decision is to be made on a communication receiver. So we will endeavor, through a series of exposures, to show what is found inside the cabinet of an RME receiver.

Under the condenser dust-cover are located the main tuning condenser, the band-spread condenser, and the dual section resonator condenser.

The stator of the main tuning condenser really consists of six sections. The object is to provide various sectional capacities for high  $Q$  circuits over the extended range of the receiver frequency. But without some means of widening the band spectrum a communication receiver would be lacking in a major essential — a low capacity condenser for bandspreading purposes. This bandspread condenser is so designed that

removal of one or two stator plates from each one of the three stator sections will provide greater separation between stations, if desired, especially on the higher frequencies.

And to go one step further in guarding against an ever-present possibility — namely, misalignment and consequent low sensitivity of the receiver — every RME instrument has a *resonator control*. This consists of a two-section variable of approximately 20  $\mu\text{fd}$  per section in parallel with the main R.F. and detector circuits. Usually many padders are utilized in lining up the circuits. These are often difficult to get at and more difficult to keep in trim. What could be more practical than a dozen padders replaced by two air-tuned trimmers adjustable from the front panel.

Every condenser unit is of the highest quality obtainable today.

The RME literature is available either through your dealer or direct from the Factory

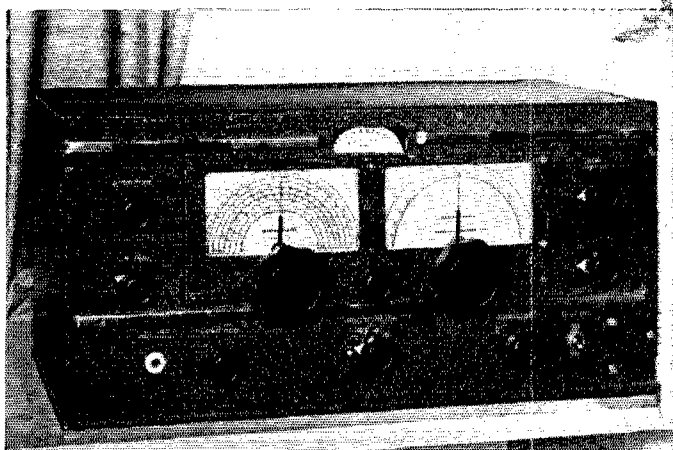

**RADIO MFG.**  
**ENGINEERS, INC.**  
PEORIA • ILLINOIS



# For Value THE UTC SPECIAL SERIES IS UNBEATABLE



## UNIVERSAL INPUT and DRIVER AUDIOS

- S-5 — Mike or line to grid, humbucking type.  
Net.....\$1.80
- S-8 — Single driver plate to pushpull grids.  
Net.....\$1.65
- S-9 — Pushpull driver plates to grids of class B tubes  
up to 400 watts output. Net.....\$2.25

## UNIVERSAL OUTPUT TRANSFORMERS

Any modulator tubes to any RF load  
DC on secondary

- S-21 — 110 watts audio power. Net.....\$6.00
- S-22 — 250 watts audio power. Net.....\$8.40

## PLATE TRANSFORMERS

Primary 115V. — 50/60 cycles

- S-48 — 1500, 1250, 1000 volts each side of center  
tap — 300 MA. Net.....\$11.70
- S-49 — 2100, 1800, 1500 volts each side of center  
tap — 300 MA. Net.....\$10.80

# FOR Quality AND Dependability THE UTC QUALITY LINES are first choice

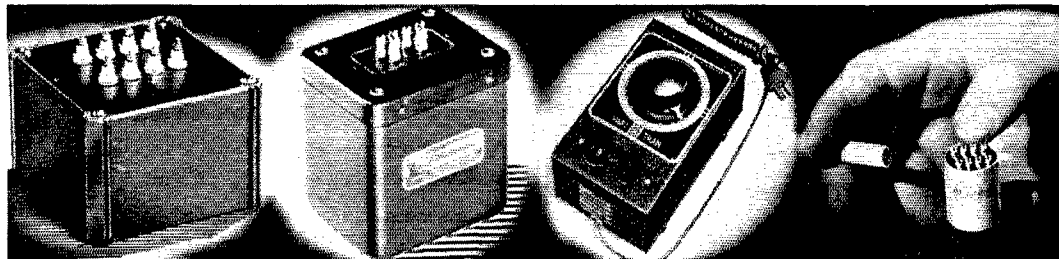

## LINEAR STANDARD

Transformers have guaranteed linear response from 30 to 20,000 cycles, ideal shielding and dependability.

### TYPICAL ITEMS:

- LS-10X — Tri-alloy shielded, multiple line to grid. Net, \$12.00
- LS-50 — Low level plate to multiple line. Net.....\$9.00
- LS-55 — 2A3's to multiple line and voice coil. Net.....\$12.00



## HIPERM ALLOY

Units are similar to LINEAR STANDARD components but employ a light-weight case, making them ideal for highest fidelity compact equipment.

### TYPICAL ITEMS:

- HA-100X — Tri-alloy shielded, multiple line to grid. Net, \$10.50
- HA-111 — Crystal mike or pickup to line. Net.....\$7.50
- HA-105 — Single plate to single grid. Net.....\$5.40



## VARITRAN

Voltage CONTROL Units

- MODEL V-1 — 570 Watts — 5 amp. maximum rating, complete with cord, plug and switch. Net.....\$10.00
- MODEL V-2 — Same as V-1, but uncased, with terminal strip for rack or panel mounting. Net.....\$9.00
- MODEL V-3 — 850 Watts maximum rating, 7.5 amp., uncased, with terminal board and provisions for mounting. Net, \$14.00
- Other sizes in stock.



## UTC OUNCER UNITS

Weigh but 1 ounce yet have high fidelity characteristics. Ideal for hearing aid, concealed service and aircraft.

### TYPICAL ITEMS:

- O-1 — Line to grid. Net....\$6.00
- O-6 — Plate to two grids. Net.....\$5.40
- O-15 — 10 to 1 interstage (voice). Net.....\$6.00

# UNITED TRANSFORMER CORP.

150 VARICK STREET

NEW YORK, N. Y.

EXPORT DIVISION 100 VARICK STREET NEW YORK, N. Y. CABLES "ARLAB"

QST for February, 1939, CENTRAL Edition

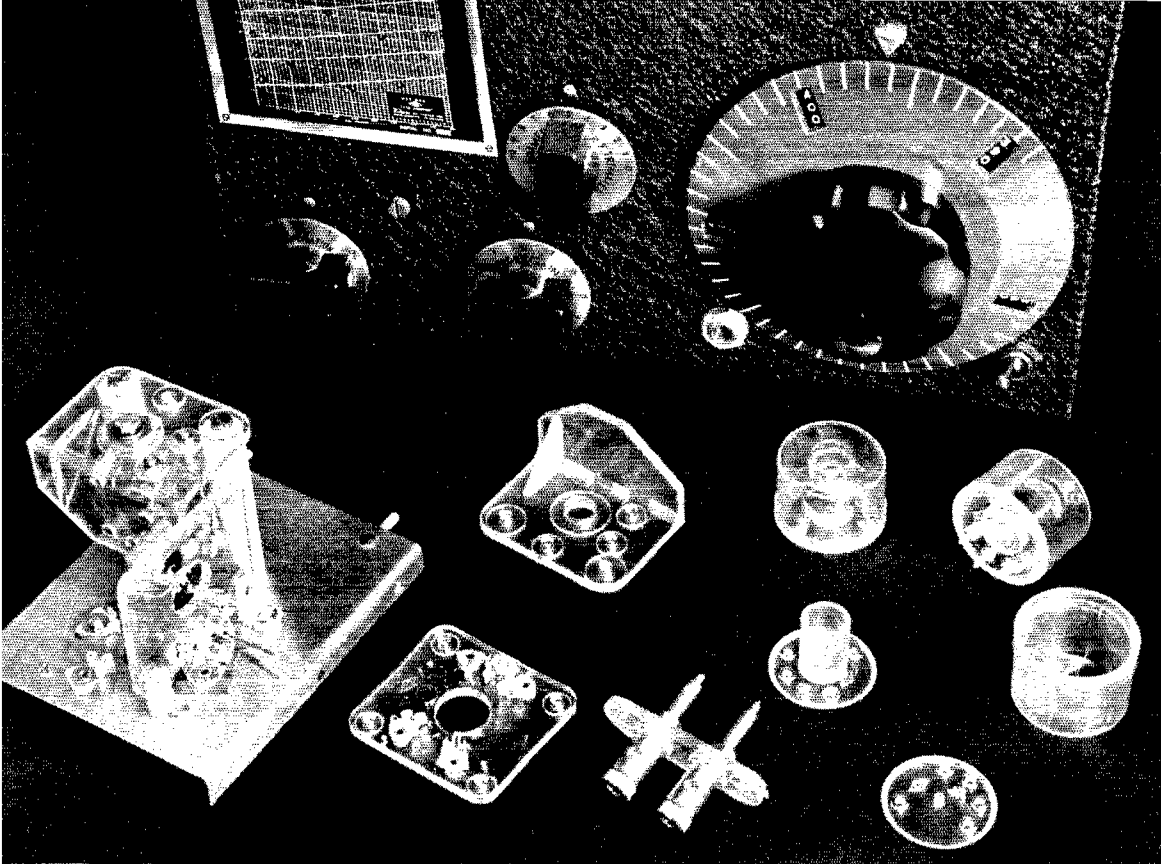

## AN IMPROVED ONE-TEN

Progress in the technique of high-pressure injection molding in this country has made it possible to improve the mechanical design of the One-Ten Receiver. The parts shown in the photograph above are made of low-loss Victron. Injection molding has made practical their intricate shapes, thin wall sections and clean appearance. They contribute much to the stability, dependability and high performance of the One-Ten.

These improvements come at a particularly appropriate time. The restrictions placed on 5-meter operation by the new regulations make the  $2\frac{1}{2}$ -meter and  $1\frac{1}{4}$ -meter bands doubly attractive for experimental operation. With high performance down to 1-meter, the One-Ten is the ideal receiver for these bands.

**NATIONAL COMPANY, INC., MALDEN, MASS.**



Get 260 watts output with less than 1 watt driving power...with

# NEW RCA 813

It's not a claim—it's an actual fact! The new RCA 813 will give you 260 watts output in Class "C" telegraph service with less than 1 watt of driving power! Needs no neutralization, and a pair of 813's makes a swell final for quick-band-change, high power transmitters.

Only 7½" long, the RCA 813 employs a new stem structure with very short heavy leads and low lead inductance. This new high power beam tube may be operated at full ratings up to 30 megacycles without neutralization.

**\$28<sup>50</sup>** AMATEUR NET

One of the finest transmitting tubes RCA has ever developed, the 813 also features heavy-duty thoriated-tungsten filament, oversized graphite plate, dome-top bulb with cushion mount supports, low screen current, and a new giant 7-pin base with short shell and wide pin spacings.

Typical operation of RCA 813, Class "C" Telegraphy... filament voltage, 10 volts (a. or d.c.); filament current, 5 amperes; D-C plate voltage, 2000 volts; D-C screen voltage, 400 volts; D-C grid voltage, minus 100 volts; D-C plate current, 180 milliamperes; D-C screen current, 15 milliamperes; Drive power, 0.5 watt; Power output, 260 watts.

## GET HIGH POWER AND SAVE 4 WAYS

This tube enables you to save on initial cost—cost of tank circuit capacitors; cost of power supply equipment—and cost of driver stage. And when it comes to high power—you'll say the 810 is FB! For it gives you plenty!

Two RCA 810's, in Class "C" telegraph service, will take one kilowatt of power at a plate voltage of only 2000 volts and a driving power of 24 watts.

## WITH THE RCA 810

The RCA 810 is of the high-mu triode type and has extremely high permeance. It features a heavy-duty thoriated-tungsten filament, a filament shield at each end which prevents escape of stray electrons, and large rugged terminals at top and side of the bulb. May be operated at frequencies as high as 30 megacycles at maximum ratings.

Maximum ratings of RCA 810, Class "C" Telegraphy... D-C plate voltage, 2000 volts; D-C plate current, 250 milliamperes; Plate input, 500 watts; Plate dissipation, 125 watts.

**\$13<sup>50</sup>** AMATEUR NET

The Nov.-Dec. issue of "Ham Tips" contains circuit information on above tubes. Ask your RCA Power Tube Distributor for your copy.

Listen to the "Magic Key of RCA" every Sunday, 2 to 3 P. M., E.S.T., on the NBC Blue Network.

### PRICES REDUCED!

With prices reduced on the following RCA power tubes you now have an excellent opportunity to save money. Compare these prices!

RCA 203-A was \$15.00	Now \$10.00
RCA 204-A was 97.50	Now 85.00
RCA 211 was 15.00	Now 10.00
RCA 803 was 34.50	Now 28.50
RCA 837 was 8.50	Now 7.50
RCA 838 was 16.00	Now 11.00
RCA 845 was 15.00	Now 10.00
RCA 849 was 135.00	Now 120.00
RCA 866-A was 4.00	Now 2.50
RCA 872 was 14.00	Now 9.00
RCA 872-A was 16.50	Now 11.00



# Radio Tubes

FIRST IN METAL • FOREMOST IN GLASS • FINEST IN PERFORMANCE

RCA MANUFACTURING CO., INC., CAMDEN, N. J.

A Service of the Radio Corporation of America